

# GLOBAL JOURNAL

OF MEDICAL RESEARCH: K

Interdisciplinary

Respiratory Exchange Ratio

Bagged Tree and SVM Algorithms

Highlights

Different Healing with Drugs

Prevention of Chronic Diseases

Discovering Thoughts, Inventing Future

VOLUME 19    ISSUE 7    VERSION 1.0





GLOBAL JOURNAL OF MEDICAL RESEARCH: K  
INTERDISCIPLINARY

---



GLOBAL JOURNAL OF MEDICAL RESEARCH: K  
INTERDISCIPLINARY

VOLUME 19 ISSUE 7 (VER. 1.0)

---

OPEN ASSOCIATION OF RESEARCH SOCIETY

© Global Journal of Medical Research. 2019.

All rights reserved.

This is a special issue published in version 1.0 of "Global Journal of Medical Research." By Global Journals Inc.

All articles are open access articles distributed under "Global Journal of Medical Research"

Reading License, which permits restricted use. Entire contents are copyright by of "Global Journal of Medical Research" unless otherwise noted on specific articles.

No part of this publication may be reproduced or transmitted in any form or by any means, electronic or mechanical, including photocopy, recording, or any information storage and retrieval system, without written permission.

The opinions and statements made in this book are those of the authors concerned. Ultraculture has not verified and neither confirms nor denies any of the foregoing and no warranty or fitness is implied.

Engage with the contents herein at your own risk.

The use of this journal, and the terms and conditions for our providing information, is governed by our Disclaimer, Terms and Conditions and Privacy Policy given on our website <http://globaljournals.us/terms-and-condition/menu-id-1463/>

By referring / using / reading / any type of association / referencing this journal, this signifies and you acknowledge that you have read them and that you accept and will be bound by the terms thereof.

All information, journals, this journal, activities undertaken, materials, services and our website, terms and conditions, privacy policy, and this journal is subject to change anytime without any prior notice.

Incorporation No.: 0423089  
License No.: 42125/022010/1186  
Registration No.: 430374  
Import-Export Code: 1109007027  
Employer Identification Number (EIN):  
USA Tax ID: 98-0673427

## Global Journals Inc.

(A Delaware USA Incorporation with "Good Standing"; Reg. Number: 0423089)

Sponsors: Open Association of Research Society

Open Scientific Standards

### Publisher's Headquarters office

Global Journals® Headquarters  
945th Concord Streets,  
Framingham Massachusetts Pin: 01701,  
United States of America

USA Toll Free: +001-888-839-7392

USA Toll Free Fax: +001-888-839-7392

### Offset Typesetting

Global Journals Incorporated  
2nd, Lansdowne, Lansdowne Rd., Croydon-Surrey,  
Pin: CR9 2ER, United Kingdom

### Packaging & Continental Dispatching

Global Journals Pvt Ltd  
E-3130 Sudama Nagar, Near Gopur Square,  
Indore, M.P., Pin:452009, India

### Find a correspondence nodal officer near you

To find nodal officer of your country, please  
email us at [local@globaljournals.org](mailto:local@globaljournals.org)

### eContacts

Press Inquiries: [press@globaljournals.org](mailto:press@globaljournals.org)  
Investor Inquiries: [investors@globaljournals.org](mailto:investors@globaljournals.org)  
Technical Support: [technology@globaljournals.org](mailto:technology@globaljournals.org)  
Media & Releases: [media@globaljournals.org](mailto:media@globaljournals.org)

### Pricing (Excluding Air Parcel Charges):

Yearly Subscription (Personal & Institutional)  
250 USD (B/W) & 350 USD (Color)



# EDITORIAL BOARD

GLOBAL JOURNAL OF MEDICAL RESEARCH

## *Dr. Jixin Zhong*

Department of Medicine, Affiliated Hospital of Guangdong Medical College, Zhanjiang, China, Davis Heart and Lung Research Institute, The Ohio State University, Columbus, OH 43210, United States

## *Rama Rao Ganga*

MBBS MS (University of Health Sciences, Vijayawada, India) MRCS (Royal College of Surgeons of Edinburgh, UK) United States

## *Dr. Feng Feng*

Boston University Microbiology 72 East Concord Street R702 Duke University, United States of America

## *Dr. Lisa Koodie*

Ph.D. in Pharmacology, University of Minnesota Medical School, Minnesota, United States

## *Dr. Krishna M Vukoti*

Ph.D in Biochemistry, M.Tech in Biotechnology, B.S in Pharmacy, Case Western Reserve University, United States

## *Dr. Xingnan Li*

Ph.D in Cell Biology, B.S in Molecular Biology, Stanford University, United States

## *Dr. Michael Wink*

Ph.D., Technical University Braunschweig, Germany  
Head of Department Institute of Pharmacy and Molecular Biotechnology, Heidelberg University, Germany

## *Dr. Han-Xiang Deng*

MD., Ph.D. Associate Professor and Research Department Division of Neuromuscular, Medicine Davee Department of Neurology and Clinical Neurosciences Northwestern, University Feinberg School of Medicine, United States

## *Dr. Roberto Sanchez*

Associate Professor Department of Structural and Chemical Biology Mount Sinai School of Medicine Ph.D., The Rockefeller University, United States

## *Dr. William Chi-shing Cho*

Ph.D., Department of Clinical Oncology Queen Elizabeth Hospital Hong Kong

## *Dr. Yash Kapadia*

Doctor of Dental Surgery, University of Louisville School of Dentistry, United States

## *Dr. Guodong Niu*

Ph.D. in Entomology, M.S. in Microbiology, B.S. in Environmental Science, The Pennsylvania State University, University Park, PA, United States

## *Dr. Arpita Myles*

Ph.D, M.Sc. in Biotechnology, B.Sc in Microbiology, Botany and Chemistry, United States

## *Dr. Wael Ibrahim Abdo Aikhiary*

Ph.d, M.Sc in Clinical Pathology, MBBCH, M.D in Medicine, Mansoura University, Faculty of Medicine, Egypt

*Dr. Izzet Yavuz*

Ph.D, M.Sc, D Ped Dent. Associate Professor, Pediatric Dentistry Faculty of Dentistry, University of Dicle, Turkey

*Dr. Rabiatal Basria SMN Mydin*

Ph.D in Cancer Genetics, BSC (HONS) in Biotechnology, University of Science Malaysia, Malaysia

*Dr. (Mrs.) Sunanda Sharma*

Ph.D, M.V.Sc., AH, M.V.Sc in Animal Reproduction, Veterinary Obstetrics and Gynaecology, College of Veterinary & Animal Science, Rajasthan Agricultural University, Bikaner, India

*Dr. Subhadra Nandakumar*

Ph.D., M.Sc in Applied Microbiology, B.Sc in Microbiology, University of Madras, India

*Sanguansak Rerksuppaphol*

Department of Pediatrics Faculty of Medicine Srinakharinwirot University NakornNayok, Thailand

*Antonio Simone Lagan*

M.D. Unit of Gynecology and Obstetrics Department of Human Pathology in Adulthood and Childhood "G. Barresi" University of Messina, Italy

*Dr. Pejic Ana*

Assistant Medical Faculty Department of Periodontology, and Oral Medicine University of Nis, Serbia

*Dr. Sunil Sirohi*

B.Pharm in Pharmaceutical Sciences, MS in Pharmacology, Ph.D in Pharmacology, Washington State University, Pullman, WA, United States

*Dr. Tsvetelina Velikova*

Ph.D, MD in Clinical Immunology, Medical University of Sofia Sofia University, Bulgaria

*Dr. M. Alagar Raja*

Ph.D in Pharmaceutical Sciences, M.Pharmacy in Pharmaceutical Analysis, B.Pharmacy S. Chattanatha Karayalar College of Pharmacy, Nalanda Collge of Pharmacy Tenkasi, Tamil Nadu, India

*Dr. Osama Hasan Alali*

Ph.D, Master's Degree, Postgraduate Diploma in Orthodontics, Dentistry, Department of Orthodontics, University of Aleppo Dental School Aleppo, Syria

*Dr. Sultan Sherif Dhastagir*

Ph.D, M.Sc in Medical Biochemistry, Faculty of Medicine, Garyounis/Benghazi University, Libya

*Dr. Seung-Yup Ku*

M.D., Ph.D., Seoul National University Medical College, Seoul, Korea Department of Obstetrics and Gynecology Seoul National University Hospital, Seoul, Korea

*Dr. Ivandro Soares Monteiro*

M.Sc., Ph.D. in Psychology Clinic, Professor University of Minho, Portugal

*Dr. Pina C. Sanelli*

Associate Professor of Radiology Associate Professor of Public Health Weill Cornell Medical College Associate Attending Radiologist NewYork-Presbyterian Hospital MRI, MRA, CT, and CTA Neuroradiology and Diagnostic Radiology M.D., State University of New York

*Dr. Alfio Ferlito*

Professor Department of Surgical Sciences University of Udine School of Medicine, Italy

*Dr. Michael R. Rudnick*

M.D., FACP Associate Professor of Medicine Chief, Renal-Electrolyte and Hypertension Division (PMC) Penn Medicine, University of Pennsylvania Presbyterian Medical Center, Philadelphia Nephrology and Internal Medicine Certified by the American Board of Int, United States

*Dr. Rajeev Vats*

Ph.D., M.Sc., B.Sc in Zoology, M.Phil in Bioinformatics, PGDCA, The University of Dodoma, Tanzania



## CONTENTS OF THE ISSUE

---

- i. Copyright Notice
  - ii. Editorial Board Members
  - iii. Chief Author and Dean
  - iv. Contents of the Issue
- 
1. Study of EEG Signal for Epilepsy Detection and Localization using Bagged Tree and SVM Algorithms. *1-6*
  2. Measuring the Vortices and Anti-Vortices of the Human Nonlinear Electromagnetic Field (NEMF) Called Chakras. *7-11*
  3. Why Does the Merging of the Parents DNAs in a Fertilized Cell Resemble Merging of Two Black Holes? – The Same Turbulent Dynamics. *13-17*
  4. Different Healing with Drugs and Alternative Medicine of Males, Females and Transgenders. *19-21*
  5. Science for the Effect of Prayer. *23-27*
  6. Computerized Acupuncture for Prevention of Chronic Diseases. *29-32*
- 
- v. Fellows
  - vi. Auxiliary Memberships
  - vii. Preferred Author Guidelines
  - viii. Index



GLOBAL JOURNAL OF MEDICAL RESEARCH: K  
INTERDISCIPLINARY  
Volume 19 Issue 7 Version 1.0 Year 2019  
Type: Double Blind Peer Reviewed International Research Journal  
Publisher: Global Journals  
Online ISSN: 2249-4618 & Print ISSN: 0975-5888

# Study of EEG Signal for Epilepsy Detection and Localization using Bagged Tree and SVM Algorithms

By Mostafa A. Abd-ElBaset & Sherif H. ElGohary

*Cairo University*

**Abstract-** Epilepsy is considered one of the common medical and social disorders with unique characteristics. EEG signal was used for the classification and detection of epilepsy. This study proposed epilepsy classification without signal decomposition, as well as other algorithms used for decomposing the EEG signal to sub-bands like discrete wavelet transform (DWT) and dual-tree complex wavelet transform (DT-CWT). Descriptive comparisons were done between results for EEG signals with/without decomposition. The proposed algorithm includes the study of the extracted features and using machine learning kernels as Support Vector Machine (SVM) and bagged tree to achieve the optimal values of (accuracy-specificity-sensitivity and execution time). Results show that adding the line length to the group of features, the accuracy increased to 99.4%. By employing decomposing the EEG signal, the accuracy could be raised to 99.875 % even after reducing the number of features to only three features. These features are line length, STD, and mean. This study proposed different algorithms with minimum features for epilepsy classification and localization with optimum execution time.

*GJMR-K Classification: NLMC Code: W 20.5*



*Strictly as per the compliance and regulations of:*



© 2019. Mostafa A. Abd-ElBaset & Sherif H. ElGohary. This is a research/review paper, distributed under the terms of the Creative Commons Attribution-Noncommercial 3.0 Unported License (<http://creativecommons.org/licenses/by-nc/3.0/>), permitting all non commercial use, distribution, and reproduction in any medium, provided the original work is properly cited.

# Study of EEG Signal for Epilepsy Detection and Localization using Bagged Tree and SVM Algorithms

Mostafa A. Abd-ElBaset<sup>α</sup> & Sherif H. ElGohary<sup>ο</sup>

**Abstract** Epilepsy is considered one of the common medical and social disorders with unique characteristics. EEG signal was used for the classification and detection of epilepsy. This study proposed epilepsy classification without signal decomposition, as well as other algorithms used for decomposing the EEG signal to sub-bands like discrete wavelet transform (DWT) and dual-tree complex wavelet transform (DT-CWT). Descriptive comparisons were done between results for EEG signals with/without decomposition. The proposed algorithm includes the study of the extracted features and using machine learning kernels as Support Vector Machine (SVM) and bagged tree to achieve the optimal values of (accuracy-specificity-sensitivity and execution time). Results show that adding the line length to the group of features, the accuracy increased to 99.4%. By employing decomposing the EEG signal, the accuracy could be raised to 99.875 % even after reducing the number of features to only three features. These features are line length, STD, and mean. This study proposed different algorithms with minimum features for epilepsy classification and localization with optimum execution time.

## I. INTRODUCTION

Electroencephalographic (EEG) provides the electrical action potentials produced by cerebral cortex neurons [1]. The ease of use and noninvasive technique gives the power to EEG to be widely used to diagnose brain diseases such as (autism-epilepsy-head injury-dementia-brain tumors, etc...).

Epilepsy is a type of neurological disease. It is ranked as second most rife neurological disorder in humans, with around 40-50 million people in the world suffer from epilepsy [2]. A seizure is a paroxysmal event happening due to hyper synchronous, excessive neuronal discharges [3]. The scalp EEG is a test used for the clinical diagnoses of Epilepsy [4, 5]. Automatic detection of seizure began in the 1970s and various methods addressing this problem have been presented [6]. Ling Guo introduced line length feature extracted from the EEG signal after discrete wavelet transform and utilized the artificial neural network as a classifier [7]. B. Suguna Nanthini et al. [8] perform automatic detection for seizure by using Shannon Entropy. They decomposed the EEG signal and utilized SVM for classification. Manisha Chandani et al. [9] applied DWT for decomposition and two classifiers (SVM and

Multilayer Perceptron Neural network) [8,9]. They represented their detection only on sets Z and S from database which introduced by (Andrzejak et al.) [10]. DWT has been used to decompose each channel signal to sub-bands. Various wavelet types have been employed such as (Daubechies, Haar, Coiflets, and Reverse Bior) with different levels. Moreover, a comparison between the wavelet types will be represented to select the optimum wavelet and level. A distinct technique was used for decomposition as DT-CWT which separates the real and imaginary parts of each signal and decomposes them by different filters. Then, line length was extracted from each sub-band in both cases (DWT and DT-CWT). After signal processing and feature extraction, the features were applied to the machine learning algorithms to classify the signal to normal or abnormal. This work introduced epilepsy classification method with optimum accuracy and execution time. Moreover, detection of the focal area will lead to estimate the location of the epilepsy source.

## II. MATERIAL AND METHODS

### a) Dataset Description

There are two different datasets. The first one which described by Andrzejak et al. [10], is employed to study the classification algorithms and the important features to be extracted. The second data set was used for applying the best technique in epilepsy classification and for localization. The first dataset consists of five sets (Z, O, N, F, and S) each set has recorded from five patients. Each patient has 20 channels sampled at 173.61Hz using 12-bits resolution. All EEG recording was preprocessed with the same 128 channel amplifier. Number of points in each signal is 4097 points with duration of 23.6 seconds. First set is Z which represented normal EEG with the eye open and taken from scalp. Set O had been recorded from the scalp but with the eye closed. Sets N, F, S were measured via intracranial electrodes. N recorded from the epileptogenic zone but F from the opposite side both at seizure-free interval. Finally, set S was taken from the epileptogenic zone but during seizure activity. The entire five datasets were filtered by filter 0.53-40 Hz band-pass and examined by a physician, as shown in figure 1. The second data set was collected by Warsaw memorial child hospital [12]. It contains records of 23 patients with

Author <sup>α</sup>: Biomedical and System Engineering Department, Cairo University, Giza 12613, Egypt. e-mail: sh.elgohary@eng1.cu.edu.eg



severe epilepsy, mostly caused by different lesions. The patients aged 1-18 years. EEG was taken by a 10-20 system with 19 electrodes sampled at 250 HZ. The hardware reference was "fpz" channel. Physicians examined each data set recording and put markers at the seizure period. With each patient, there is an MRI image that locate the focal area of epilepsy in the brain. A random EEG signal to patient id "Chimic" shown in figure 2, and the seizure period marked by physicians.

b) Discrete wavelet transforms (DWT) Analysis

Recently, a discrete wavelet transform (DWT) widely applied in many engineering fields for solving various real-life problems [11]. DWT equation is shown below [13]:

$$DWT_{(j,k)} = 2^{-\frac{j}{2}} \int_{-\infty}^{\infty} S(t)\varphi\left(\frac{t - 2^j k}{2^j}\right) dt \quad (1)$$

Where:  $\varphi$  is the given mother wavelet, J is the scale parameters, and k is the shift parameter.  $S(t)$  is the signal in the time domain.

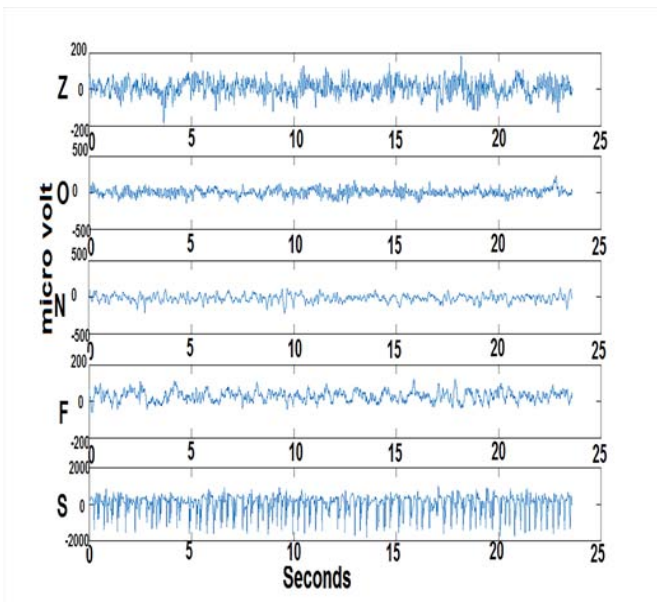

Fig. 1: EEG signals from five different sets (Z, O, N, F, and S) where x-axis for seconds and y-axis for micro volt.

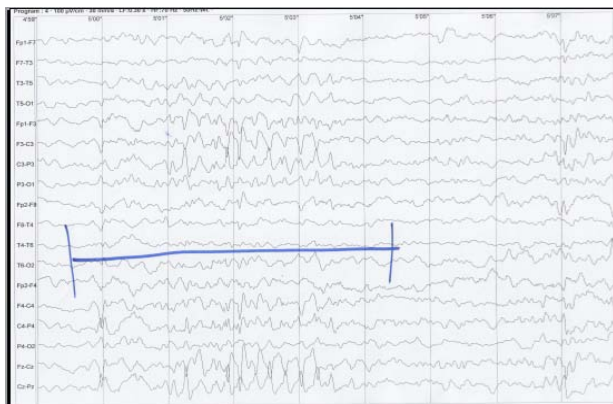

Fig. 2: EEG signals from patient id "Chimic"

Equation (1) shows the signal decomposition to sub-bands. DWT is an efficient method to decompose the EEG signal to sub-bands by applying a set of low-pass filters  $g(n)$  and high-pass filters  $h(n)$  on the signal as shown in Figure.3. This operation repeated the same value as the choosing level. We choose the level to be four that generates five sub-bands, as described in Table 1.

We used various wavelets techniques such as Daubechies (dB), Haar, Coiflets, and Reverse Bior. Selecting the optimum technique and order is our aim to be the input of the feature extraction stage. The wavelet type evaluation depends on the execution time of signal decomposition and parameters such as (accuracy, specificity, sensitivity) of the classification algorithms.

c) Analysis with double-tree complex wavelet transforms (DT-CWT)

DWT has certain limitations, first a small change in input signal will lead to a large change in wavelet coefficients. Second, it has poor directional selectivity [14].

To overcome those limitations, we introduced DT-CWT, as shown in Figure 4. A group of low-pass and high-pass filters used for decomposition. This process repeated until the system reaches 4<sup>th</sup> stage. The upper part of the tree for the real part ( $h_0, h_1$ ) where  $h_0$  for low pass filters and  $h_1$  for high pass filters. The lower part of the tree for the imaginary part ( $g_0, g_1$ ) where  $g_0$  for low-pass filters and  $g_1$  for high-pass filters. Equation (2) shows the relation between the upper tree and the lower tree. Where the upper filters and the lower filters are half sampled delay as follow:

$$g_0(n) = h_0(n - 0.5) \quad (2)$$

DT-CWT decomposes the EEG signal to complex wavelet function and scaling function.  $\varphi_c$  is the complex wavelet function transform and described by Equation (3). Where  $\varphi_r$ , the real part, is related to the upper tree, and  $\varphi_i$  is the imaginary part that related to the lower tree.

$$\varphi_c(t) = \varphi_r(t) + j\varphi_i(t) \quad (3)$$

The scaling function  $\phi_c$  was represented by equation (4), where  $(\phi_r, \phi_i)$  for real and imaginary part, respectively. "t" is the time domain transformation.

$$\phi_c(t) = \phi_r(t) + j\phi_i(t) \quad (4)$$

Table1: Frequency bands of EEG signals with four-level DWT decomposition. ("A" stands for approximation, and "D" stands for details; the number following the letter is the level.)

Sub-signals	Frequency bands (Hz)	Decomposition level
D1	43.4–86.8	1
D2	21.7–43.4	2
D3	10.8–21.7	3
D4	5.4–10.8	4
A4	0–5.4	4

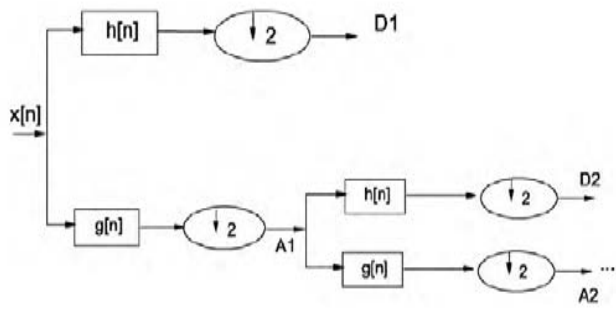

Fig. 3: Discrete wavelets transform (DWT) implementation sub-band decomposition where g (n) is low pass filters and h (n) high pass filters.

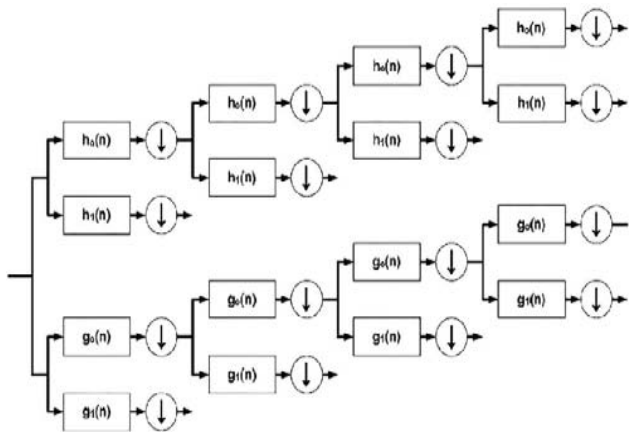

Fig. 4: Double-tree complex wavelets transform (DT-CWT) implementation real and imaginary parts decomposition (four levels).

d) Feature Extraction

Detection of epileptic seizures depends on two types of features driven from signal's amplitude, such as (Min, Max, etc...) and the frequency features. High accuracy results achieved from a combination of amplitude and frequency features such as line length "LL".

The features included in our study in EEG signal without decomposition were (Min, Max, Mean, Median, Mode, 1st quartile, 3rd quartile, Inter Quartile Rang (IQR), Standard division (STD), and LL. However, we applied the line length feature to the decomposition signal in all sub-bands.

Line length is a parameter to measure signal complexity or waveform fractal dimension, and it's like Katz's fractal dimension, as stated in [7, 15], and describes in Equation (5).

$$LL = \frac{1}{N-1} \sum_{i=1}^{N-1} abs(X_{i+1} - X_i) \tag{5}$$

Where,

X stands for the signal, N is the total number of samples and I is the signal samples indices.

A proposed algorithm was built to take each sub-band and divided it into sub-signals. Sixty-four points were chosen to be the length of each sub-signal. The output will be a matrix [m, n] where (m) is rows which equals 64 that is the total number of segments, and (n) is the column that will be the total number of features.

e) Epilepsy Classification

Classifying data is a vital task in machine learning algorithms. Support vector machine (SVM) was used to assort not only linear classification but also non-linear classification by using the Kernel trick, which is Transforming data into another dimension that has a clear dividing margin between all classes of data.

$$K(x, y) = xy + x^2y^2 \tag{6}$$

Equation (6) describes the kernel trick using a kernel function K(x, y) where the training points mapped to a 3-dimensional space where a separating hyper-plane can be easily detected [8]. There are several types of SVM (linear-quadratic, cubic, fine Gaussian, medium Gaussian, coarse). Bagged trees algorithm will be introduced on this work. Bagging is a method for enhancing the results of machine learning classification algorithms. This technique leads to classify epilepsy, and reduces the variance, which helps to avoid over fitting problem [9].

Four channels from the normal persons and nine channels from the patients are used to build the learning dataset. Cross-validation was utilized with five folds. A twenty randomly channels from sets (Z, O, N, F, S) will be classified. Finally, obtain Accuracy, Specificity, Sensitivity, and execution time). As shown in Equations (7, 8, 9).

$$Accuracy (Acc) = \frac{TP+TN}{TP+FP+TN+FN} \tag{7}$$

$$Specificity (Sp) = \frac{TN}{TN+FP} \tag{8}$$

$$Sensitivity (Se) = \frac{TP}{TP+FN} \tag{9}$$

Where,

TP, TN, is the true positive and true negative, respectively. FP, FN, is the false positive and false negative, respectively.

Execution time is the elapsed time that the program used only for classification. The computer hardware was CORE i5 with 4 GB ram.

We used four types of classification. Type I is performed on the ten features without DWT. While type II performed on the better of two classifiers without, the line length feature and decomposition. While type III executed on line length feature only for the five sub-bands after DWT. Finally, type VI, DT-CWT applied with level four and line length feature.

f) *The Localization*

i. *EEG LAB*

EEG LAB is utilized as an open-source Matlab toolbox used for EEG signal analysis. The feature extraction and plotting procedure of the spectra in the time domain and frequency domains added to the open-source code. Moreover, EEGLAB will be edited to generate a heat map 2D model of the scalp that represents the area that caused the seizure.

ii. *Classification*

The classification procedure started to estimate the variation of amplitude in all channels. As the variation of all channels amplitude occurred, that will be a sign of the seizure period as seen in figure. 5.

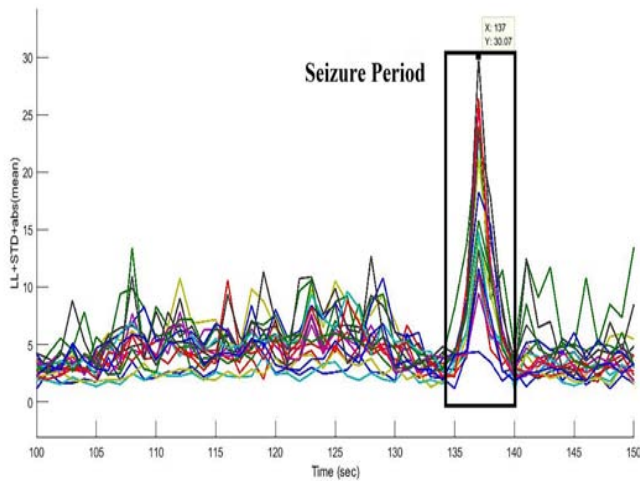

Fig. 5: EEG signal with a seizure period as labeled by a black box.

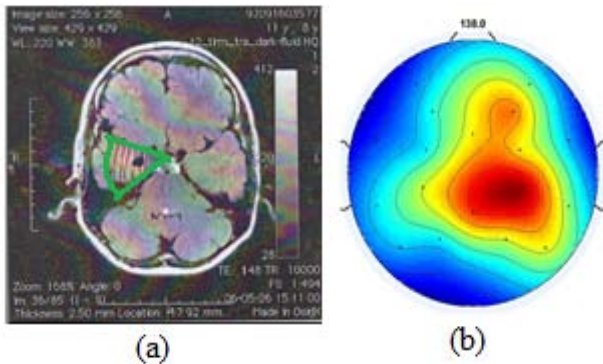

Fig. 6: a. An MRI image with a green marked focal area. b. The generated heat map model.

iii. *EEG Mapping and Localization*

After finishing classification, the tool will localize the most affected channel in amplitude and plot a heat map model to the scalp that appears the affected area in more red color and less affected area in blue. Then, we validated the affected area generated by our system with the area determined by the physician on MRI image, as seen in figure. 6.

III. *RESULTS AND DISCUSSION*

A classifier evaluation procedure performed to select DWT types. Table 2 shows the results of the types of SVM and Bagged tree algorithms while using ten features without using signal decomposition methods. Medium Gaussian SVM and Bagged tree improves the accuracy for classification. Table 3 shows the change in the result while not using line length and only use the nine features (Min, Max, Mean, Median, Mode, STD, 1<sup>st</sup> Quartile, 2<sup>nd</sup> Quartile, 3<sup>rd</sup> quartile, IQR). The line length feature shows tremendous enhancement, as seen in table 2 and table 3.

Table 2: Comparison between the SIX types of SVM and bagged tree algorithm (LL included).

Algorithm	ACC	SP	SE	Execution Time (ms)
Linear SVM				
Quadratic SVM	98.6%	99%	98.2%	19
Cubic SVM	99.34%	99.4%	99.2%	25
Fine SVM	98.18%	99.2%	93.9%	24
Medium SVM	99.25%	99.3%	99.1%	22
Coarse SVM	99.4%	99.35%	99.3%	22
Bagged Tree	98.6%	99%	97.3%	23
	99.3%	99.4%	99.1%	78

Table 3: Comparison between the best type of SVM and bagged tree algorithm. (LL not included).

Algorithm	ACC	SP	SE	Execution Time (ms)
Medium SVM	98.2%	98.3%	97.6%	21
Bagged Tree	98.1%	98.2%	97.6%	74

Table 4: Comparison between the six types of SVM and bagged-tree algorithm by using DWT with db4.

Algorithm	ACC	SP	SE	Execution Time (ms)
Linear SVM				
Quadratic SVM	99.5%	99.8%	98.2%	17
Cubic SVM	99.4%	99.5%	98.9%	21
Fine SVM	99.5%	99.7%	99%	20
Medium SVM	99.6%	99.6%	99.5%	22
Coarse SVM	99.8%	99.75%	99.6%	19
Bagged Tree	99.5%	99.6%	99%	19
	99.65%	99.64%	99.68%	50

Table 5: Effect of DWT types and orders in Medium SVM

Algorithm	ACC	SP	SE	Execution time(ms)
Db4	99.8%	99.75%	99.6%	19
Haar	98.2%	99.6%	92.03%	17
Coif3	99.6%	99.7%	99.5%	20
Coif4	99.7%	99.8%	99.55%	22
Rbio3.9	99.5%	99.4%	99.6%	23
Rbio4.4	99.4%	99.3%	99.4%	25



DWT is applied to the signal and extracts the line length feature from the five sub-bands, as in table.4. Reducing the number of features from ten to only five will have a massive effect on the execution time, particularly on the bagged tree algorithm. Table 5 and 6 show different types of DWT and their orders. Table 5 shows medium and fine Gaussian SVM results for db and coif with 4<sup>th</sup> order and Coif at the optimum level. When the order increases the execution time increases too, while the accuracy stay the same.

Table 6 shows the effect of different types and orders of DWT on the bagged tree algorithm. A comparison in accuracy between Db4 and Coif 4 both almost the same, but the execution time of Db was a little bit better. Moreover, we applied DT-CWT to the signal, and line length feature extracted from different levels as declared in table 7.

Table 6: Effect of DWT types and orders in Bagged tree.

Algorithm	ACC	SP	SE	Execution time(ms)
Db4	99.65%	99.64%	99.68%	50
Haar	98.5%	99.3%	94.5%	32
Coif3	99.6%	99.5%	99.4%	41
Coif4	99.6%	99.65%	99.55%	54
Rbio3.9	99.4%	99.4%	99.5%	49
Rbio4.4	99.2%	99.1%	99.4%	61

Table 7: The result achieved by DT-CWT.

Algorithm	ACC	SP	SE	Execution Time (ms)
Fine Gaussian SVM	99.875	99.9	99.68	85
Bagged tree	99.25	99.37	98.75	225

DT-CWT gives the optimum classification result with the fine Gaussian SVM as it uses the real and imaginary parts of the signal but with higher execution time. Wavelet types in DWT show improvement in the classification accuracy.

Therefore, choosing the optimal wavelet type will enhance the final result. Moreover, Median-SVM and bagged trees give the best result compared with the related work.

Table 8 shows a comparison between the proposed method and literature reviews done on the same dataset. Previously, some researchers evaluate their work only by set Z, and S. However, this work utilized all different sets Z, O, N, F as normal person dataset and S as patient dataset.

After using the localization procedure on the second dataset, a heat map model is most similar to the MRI image. Figure 7 shows the heat map at different seizure periods.

Table 8: A comparison of the accuracy of proposed work and related works.

Researchers	Method	Dataset	Acc%
Kannathal et al.2005b	Entropy measures-adaptive neuro fuzzy inference system	Z,S	99.20
Kannathal et al.2005a	Chaotic measures-surrogate data analysis	Z,S	~90.0
Polat and Gunes.2007	FFT-Decision tree	Z,S	98.72
Subasi 2007	DWT mixture of expert model	Z,S	95.00
Tzallas et al.2007b	Time frequency analysis ANN	ZONF-S	97.73
Ling Guo et al.2010	DWT Line length-MLPNN	ZONF-S	97.77
Suguna et al.2014	SVM with Shannon Entropy	Z,S	95.00
Manisha et al.2018a	DWT -MLPNN	Z,S	100.0
Manisha et al.2018a	DWT-SVM	Z,S	99.00
This work	DWT-Line length-SVM	ZONF-S	99.80
This work	DWT-Line length-Bagged Tree	ZONF-S	99.65
This work	DT-CWT fine Gaussian SVM	ZONF-S	99.875

#### IV. CONCLUSION

Seizure detection is a significant step for epilepsy classification. This work shows that decomposing the EEG signal enhancing the evaluation parameters result. Utilizing DT-CWT in signal decomposition and fine Gaussian SVM will improve the SP and SE of classification, but the execution time was higher as a comparison with DWT. The classification execution time is vital as the classification accuracy. As for real-time EEG data, the classification delay could have magnificent effect on system performance. Such outputs will help on real-time analysis to test the performance and localize the cerebral cortex focal area. As passing throw the localization, the application proves that determining the focal area could be achieved from the EEG signal.

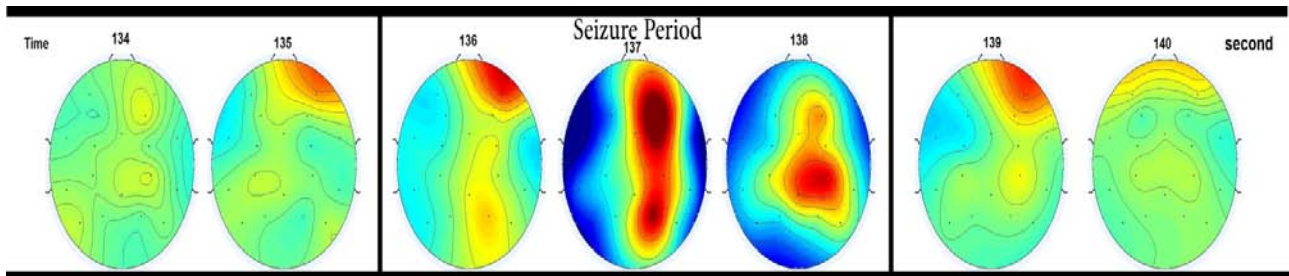

Fig. 7: Heat map model for the same patient at different periods.

## REFERENCES RÉFÉRENCES REFERENCIAS

1. Suguna Nanthini, B. and B. Santhi, 2012. Qualitative diagnostic criteria into objective quantitative signal feature classification. *JATIT*, 42: 94-99.
2. Kandel I E, Schwartz J, Jessell T. *Principles of Neural Science*. New York: McGraw-Hill, Health Professions Division; 2000.
3. Misra, U. K and J. Kalita, 2009. *Clinical Electroencephalography*. Published by Elsevier, a division of Reed Elsevier India Private Limited.
4. Subashi A. Epileptic seizure detection using dynamic wavelet network. *Expert Systems with Applications* 2005b; 29(2): 343-55.
5. Subashi, A., 2007. EEG signal classification using wavelet feature extraction and a mixture of expert model. *Expert Systems with Applications*, 28(4): 701-711.
6. Mohseni H, Maghsoudi A, Kadbi M, Hashimil, Ashourvan A. Automatic detection of epileptic seizure using time-frequency distributions. In: *IET 3<sup>rd</sup> International Conference on Advances in Medical, Signal and information Processing, MEDSIP*; 2006. P. 1-4.
7. Ling Guo, Daniel Rivero, Julian R. Rabunal, Alejandro Pazos. Automatic epileptic seizure detection in EEGs based on line length feature and artificial neural networks. 2010.
8. B. Suguna Nanthini and B. Santhi. EEG Signal Analysis for Epileptic Detection Using Soft Computing Techniques: 65-69, 2014.
9. Manisha Chandani, Arun Kumar. EEG signal processing for epileptic seizure Prediction by using MLPNN and SVM Classifiers. *American Journal of Information Science and Technology*. Vol. 2, No. 2, 2018, pp 36-41.
10. Andrzejak R, Lehnertz K, Mormann F, Rieke C, David P, Elger C. Indications of nonlinear deterministic and finite-dimensional structures in time series of brain electrical activity: dependence on recording region and brain state. *Physical review E* 2001; 64(6): 061907-1-8.
11. Piotr Zwolinski, Marcin Roszkoski, Jaroslaw Zygierevicz, Stefan Haufe, Guido Nolte, Piotr j. Durka. Open Database of Epileptic with MRI and Post Operational Assessment of Foci—a Real World Verification for the EEG Inverse Solutions.
12. Zwoliński P., Roszkowski M., Zygierevicz J., Haufe S., Nolte G., Durka P. J. Open database of epileptic EEG with MRI and post operational assessment of foci—a real world verification for the EEG inverse solutions. *Neuro informatics*. 2010; 8(4): 285–229.
13. Chui C. *An Introduction to Wavelets*. Boston: Academic Press; 1992. Dingle A, Jones R, Carroll G, Fright W. A multistage system to detect epileptic form activity in the EEG. *IEEE Transactions on Biomedical Engineering* 1993; 40(12): 1260-8.
14. S. Deivasigaman, C. Senthilpari, Wong Hin Young. Classification of Focal and Non focal EEG Signals Using ANFIS Classifier for Epilepsy Detection; 2016.
15. Esteller R, Echaz j, Tchong T, Litt B, Line length: An efficient feature for seizure onset detection. In: *23<sup>rd</sup> Annual International Conference of the IEEE Engineering in Medicine and Biology Society*; 2001. p.4.



GLOBAL JOURNAL OF MEDICAL RESEARCH: K  
INTERDISCIPLINARY  
Volume 19 Issue 7 Version 1.0 Year 2019  
Type: Double Blind Peer Reviewed International Research Journal  
Publisher: Global Journals  
Online ISSN: 2249-4618 & Print ISSN: 0975-5888

# Measuring the Vortices and Anti-Vortices of the Human Nonlinear Electromagnetic Field (NEMF) Called Chakras

By Prof. Maria Kuman

**Abstract-** Both Man and Sun have the same donut shaped nonlinear electromagnetic field (NEMF) with similar dynamics. Our Sun has a chain of clockwise spinning vortices sucking energy in alternating with counterclockwise spinning anti-vortices throwing energy out. The human NEMF has also a chain of vortices sucking energy in, alternating with anti-vortices throwing energy out. However, while the dynamic of the Sun is physics because the energies are colossal, the dynamic of the human NEMF (which is the same, but weak and difficult to measure) was mocked with the name metaphysics and thrown out of physics. 'Metaphysics' means 'beyond physics' in Greek. However, with time all phenomena, which our physics couldn't explain, became a bad thing - metaphysics. Meanwhile, physics was further developed and nonlinear physics could explain the so-called metaphysics, but the physicists seem to be afraid to touch the mocked metaphysics. The chain of spinning alternating vortices and anti-vortices of the human NEMF were called 'chakras' in ancient Hindu texts, which means 'spinning wheel'. The chakras just need a sensitive enough equipment to measure them and the author had developed such equipment. Also, the chakras could be photographed in high frequency electric field, which multiplies the chakras' photons and makes their photographing possible.

**Keywords:** *chakras, hormones, personality, behavior, behavioral problems, autism, bipolar disorder, endocrinology, psycho-endocrinology, psychology, psychiatry, metaphysics, physics.*

**GJMR-K Classification:** NLMC Code: WK 102



MEASURINGTHEVORTICESANDANTI-VORTICESOFTHEHUMANNONLINEARELECTROMAGNETICFIELDNEMFCALLEDCHAKRAS

*Strictly as per the compliance and regulations of:*



RESEARCH | DIVERSITY | ETHICS

© 2019. Prof. Maria Kuman. This is a research/review paper, distributed under the terms of the Creative Commons Attribution-Noncommercial 3.0 Unported License <http://creativecommons.org/licenses/by-nc/3.0/>, permitting all non commercial use, distribution, and reproduction in any medium, provided the original work is properly cited.

# Measuring the Vortices and Anti-Vortices of the Human Nonlinear Electromagnetic Field (NEMF) Called Chakras

Prof. Maria Kuman

**Abstract-** Both Man and Sun have the same donut shaped nonlinear electromagnetic field (NEMF) with similar dynamics. Our Sun has a chain of clockwise spinning vortices sucking energy in alternating with counterclockwise spinning anti-vortices throwing energy out. The human NEMF has also a chain of vortices sucking energy in, alternating with anti-vortices throwing energy out. However, while the dynamic of the Sun is physics because the energies are colossal, the dynamic of the human NEMF (which is the same, but weak and difficult to measure) was mocked with the name metaphysics and thrown out of physics. 'Metaphysics' means 'beyond physics' in Greek. However, with time all phenomena, which our physics couldn't explain, became a bad thing - metaphysics. Meanwhile, physics was further developed and nonlinear physics could explain the so-called metaphysics, but the physicists seem to be afraid to touch the mocked metaphysics. The chain of spinning alternating vortices and anti-vortices of the human NEMF were called 'chakras' in ancient Hindu texts, which means 'spinning wheel'. The chakras just need a sensitive enough equipment to measure them and the author had developed such equipment. Also, the chakras could be photographed in high frequency electric field, which multiplies the chakras' photons and makes their photographing possible. It is called Kirlian photography. Isn't it time to include the chakras in our nonlinear physics?

**Keywords:** *chakras, hormones, personality, behavior, behavioral problems, autism, bipolar disorder, endocrinology, psycho-endocrinology, psychology, psychiatry, metaphysics, physics.*

## I. INTRODUCTION

Ancient books on acupuncture claim that the acupuncture meridians are like rivers, but along them energy (Chi) runs instead of water. In the way the rivers flow into sea, the acupuncture meridians flow into 6 seas, which are spinning energy seas. From contemporary retrospection, these spinning energy centers are the alternating vortices and anti-vortices of our NEMF.

The Sun and our human bodies have the same type of donut-shaped NEMF [1] and have similar turbulent dynamic. Our Sun has two chains of vortices spinning clockwise (rightward) and sucking energy alternating with anti-vortices spinning counter clockwise (leftward) and emitting energy. The two chains run

parallel to the equator and the turbulent spinning in the northern hemisphere is opposite to the turbulent spinning in the southern hemisphere (Fig. 1).





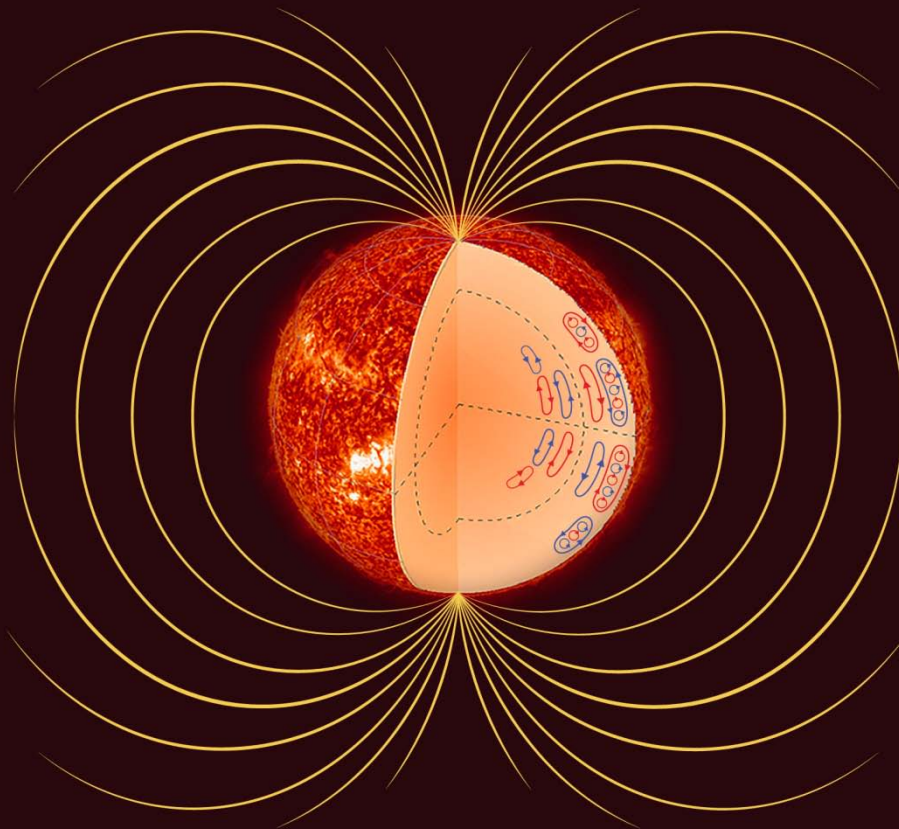

*Fig. 1:* The Sun's NEMF and its turbulent dynamic

It seems that the androgynous NEMF of the Sun has been split through the equator and from the southern half the male (Yang) Spirit was created, while from the northern hemisphere the female (Yin) Spirit was created. As a result each of the genders had one chain of alternating vortices and anti-vortices and they span in opposite directions in males and females.

However, since the NEMF is a self-organized field, after the splitting each of the genders had a torus shape field. However, now the chain of alternating vortices and anti-vortices was along the backbone, which was the axis of spinning of the donut (Fig. 2). Just like the Sun, our body breathes (sucks) energy in through its spinning-clockwise vortices and breathes (emits) energy out through the spinning-counterclockwise anti-vortices [1].

The six spinning energy centers along the backbone alternate vortex, anti-vortex, vortex, etc. and each of them rules an endocrine gland. They are called

in ancient Hindu texts "chakras", which in the Sanskrit language means "spinning wheel". The seventh chakra on top of the head is called "point of union" because it unites the energies of all 6 underlying chakras.

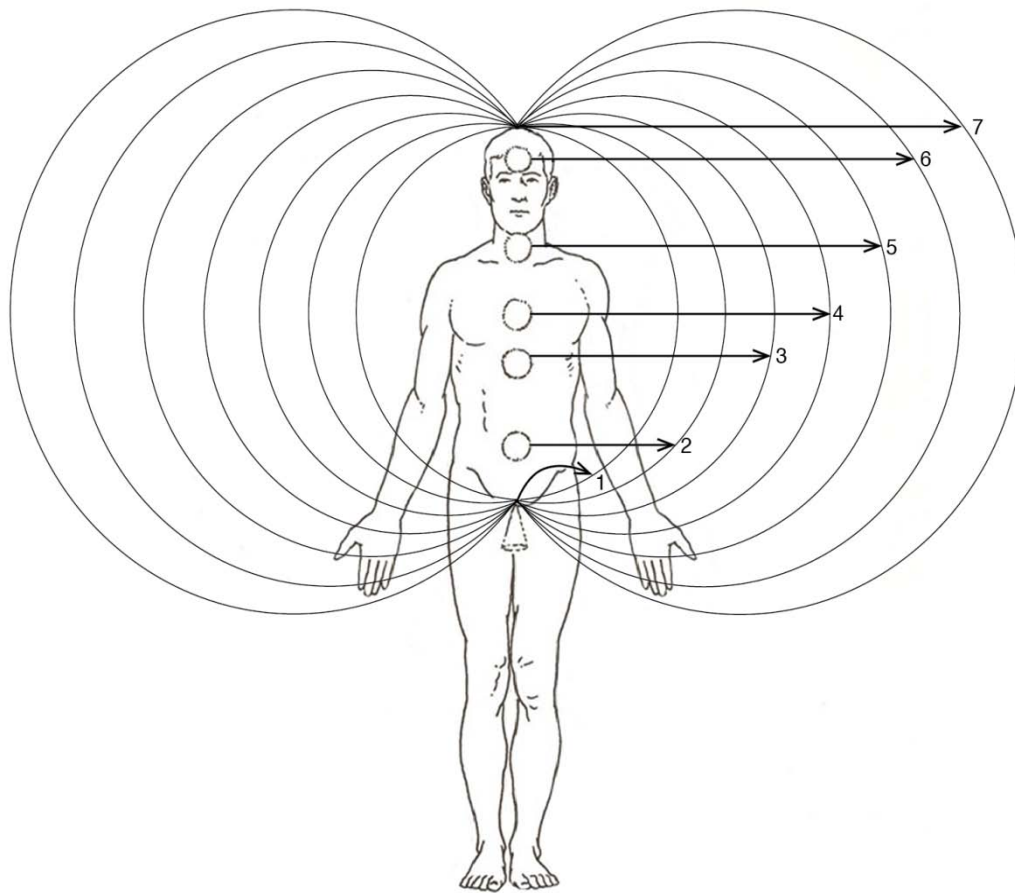

Fig. 2: The six body chakras and their corresponding energy levels

It can be seen on Fig. 2 that the seventh chakra on top of the head really unites (and rules) the function of the six chakras lying under it [2], [3]. In the Chinese acupuncture this point is called “Bai Hwei”, which means “Point of Union”. Fig. 2 depicts vertical cross-section of the donut, the seven spinning energy centers along the backbone (numbered from bottom to top) called basic chakras, and the seven energy levels of our NEMF related to them.

The six spinning energy centers are very important because they rule and regulate the six endocrine glands, which produce and release into the bloodstream hormones and these hormones rule and regulate all the processes in the body. “Hormao” means “exciting”. The name came from the first substance emitted from an endocrine gland, which was found to be exciting in very small amounts (mg per liter blood). It was called “hormone”.

However, to be able to regulate, the endocrine glands must also produce inhibiting hormones and they do. However, the substances that inhibit in very small amounts were also called hormones (which is not right). In ancient Chinese books on acupuncture, both kinds of hormones (exciting and inhibiting) were called “Essence of Life”. This would be the right name for them because

they do both excite or inhibit in amounts mg per liter blood.

The hormonal balance determines our state of health (physical and mental), our psychic balance, and our type of personality. Since the chain of energy centers with alternating spinning, which we call chakras, rule the hormonal balance, this makes the energy balance of the chakras essential for our physical and mental health. It also reflects our type of personality.

## II. THE SIX SPINNING ENERGY CENTERS OF THE HUMAN BODY

Let’s briefly list some of the spinning energy center of our NEMF, which are a chain of alternating vortices and anti-vortices along the backbone, and which in ancient Hindu texts are called chakras (spinning wheels). They are consequently numbered from the tailbone to the top of the head:

The first chakra is located at the tailbone. It resembles a spinning tornado and it is the facing downward funnel of our donut-shaped nonlinear energy field. It is called ‘ground chakra’ or ‘earth chakra’ because it connects us energetically to the center of the earth. Since the center of the earth is red magma, the first energy chakra is red in color. It rules and regulates

the function of the adrenal glands on top of the kidneys, which produce and secrete into the bloodstream the hormones cortisol, adrenaline, and noradrenaline.

When the energy of the first chakra is high, the person is well grounded and stable. If such a person happens to experience a financial crisis or other disaster, usually it is not for a long time. Soon he will be on his feet again proceeding with another business and being successful again.

The seventh chakra is located on top of the head and it is a spinning energy funnel open upward. This upper spinning funnel of our donut-shaped NEMF connects us to the cosmos and the atmosphere. It integrates the energy of all six chakras lying under it when the body is erect.

The rest of the chakras are horizontal with two funnel openings - one in the front and one in the back. Such is the second chakra located one inch below the belly button. It is called sexual chakra because it rules and regulates the function of the sexual organs. While the first chakra relates to our instincts to survive, the second chakra relates to our instincts to multiply.

The sexual chakra is orange in color and controlling behavior usually depletes its energy. Controlling people, who are trying to be in control of the lives of everybody around, usually have depleted sexual chakra because the chakra is leaking energy. Sooner or later they suffer cancer or other diseases of the sexual organs.

The third chakra is related to the solar plexus, which is a nerve ganglion with radial neurons spreading like the rays of the sun. This is the Sun of our body, and since our sun is a yellow star, it is yellow in color. It rules the functioning of the pancreas, gall bladder, liver, spleen, and stomach.

When the energy of the third chakra is low, the person has low will power, low self-confidence, and has difficulty making decisions. When the energy of the third chakra is high, the person has high self-confidence, makes decisions easily, and has strong will power. He is the man or woman of success.

More information about chakras can be found in the books of the author: M. Kuman, Yoga – Health Benefits, Science, and Wisdom [2] and M. Kuman, Find Your Soul Mate – Secrets of the Soul [3].

### III. RUSSIAN MEASUREMENTS OF THE INTENSITY OF EMISSION FROM THE SPINNING ENERGY CENTERS

The Russian scientist, Acad. Goskov, held water in front of different chakras at distance 20 cm for 40 minutes and then used this water to germinate wheat. The number of germinated wheat was a measure of the photon emission of the chakra.

The emission of chakras #3, #4, #5, and #6 was investigated and it was found that the emission of

chakra #3 (Solar Plexus) and chakra #5 (Throat Chakra) was maximal and had maximal influence on wheat germination [4]. Amazingly, in ancient Hindu text these two chakras are called “Chakras of Communication”.

Also, it was found that the emission of these four measured chakras is anisotropic, i.e. having maximal intensity in front and in the back. Amazingly, ancient Hindu text claim that the four chakras #2, #3, #4, and #5 (spinning wheels) are horizontal with channeled funnel-like emission in front and in the back.

### IV. OUR MEASUREMENTS OF THE SPINNING ENERGY CENTERS TO DIAGNOSE BIPOLAR DISORDER

When measuring chakras for more than 30 years, I noticed that when the energy of the second (sexual) chakra is high, but the energies of the first and third chakras are low, expect bipolar personality. However, if the person is controlling and has a leaking second chakra, he might be bipolar and not show this specific imbalance.

Measuring the chakra balance to diagnose bipolar disorder would help distinguish between irregular function of thyroid gland and bipolar disorder. The symptoms of both disorders are the same and frequently irregular function of thyroid gland is diagnosed as bipolar disorder. This makes the doctor wonder why their medications do not help all their patients.

Measuring the chakra balance helps to distinguish between bipolar disorder, when we find that the second chakra has higher energy, and irregular function of the thyroid gland when we find abnormal energy in the fifth chakra, called the “Throat Chakra”. Normally, patients with thyroid problem feel worse when taking the prescribed to them medication for bipolar disorder.

We are the first to diagnose mental diseases with measurements of chakras, which reflect the hormonal balance, because we have a high sensitive equipment that allows us to measure non-evasively the weak human NEMF and its vortices and anti-vortices. However, more than 40 years ago Dr. Belkin in Russia created Institute of Psycho-endocrinology at the Psychiatric Hospital in Moscow and he successfully treated mental disorders with hormones [5].

### V. MEASURING THE SPINNING ENERGY CENTERS TO DIAGNOSE AUTISM

At the present moment health insurance companies claim that autism is a behavioral problem, not a health problem, and refuse to pay for treatment of autistic children. However, as already said both chakras and hormonal balance relate to behavior and our preliminary measurements of autistic children revealed

severe hormonal imbalance (more than one chakra is out of balance).

However, the imbalance was found to be different for different types of autism. It turned out that some autistic children have slow development because they cannot assimilate sugar (and turn it in glucose) and their brain is starving because the brain consumes 60% of the glucose while being 2% of the body weight.

Other autistic children showed intolerance to foods. We can measure with our equipment which foods the autistic child cannot tolerate and which foods will be beneficial. It is different for different children. Measurements of chakras not only allow us to see the nature of these and others behavior-related problems, they allow us to see what kind of hormonal imbalance causes the problem.

However, not all autistic children have food related problems. But we found that all autistic children, who have communication problem, have low energy in their Fifth (Throat) Chakra, which is called "Chakra of Communication". The energy of their fifth chakra is only 20% of what it should be, which explains their lack of ability to communicate. However, these 20% give us hope that if this chakra is stimulated with acupuncture, its energy would increase and this would eliminate the communication problem of the autistic children.

## VI. MEASURING THE SPINNING ENERGY CENTERS FOR CANCER DIAGNOSIS

It has been known for a long time that hormonal imbalance causes cancer. A book was published as far back as in 1976 in the US with the title *Hormones and Cancer* [6]. Since measurements of the spinning energy centers, called chakras, give us information about the hormonal balance, and cancer is hormonal imbalance, measuring chakras should be a good and reliable way for very early diagnose of cancer, long before the malignancy would appear.

Ancient Chinese texts claim that to try to cure chronic diseases and cancer when they are established with all their symptoms would be like starting to make weapons to fight when the enemy is already in your yard. I claim with certainty that hormonal changes can be detected long before the malignancy because changes in the temperature cycle (which is a hormonal cycle) were observed by Halberg years before the malignancy would appear [7]. (For chakras with numbers higher than 7, see the book of the author M. Kuman, *Quantum Mind and Quantum Growth - Levels of Spiritual Growth*, [8]).

## VII. CONCLUSIONS

To learn more about chakras, contact us and enroll in our workshops or classes. We can explain chakras scientifically, and we don't know anybody else who can measure them. By measuring your chakras, we

can check your endocrine balance, which determines your physical and mental health.

If a chakra has permanently low energy, probably there is a permanent energy leak. Usually, behavioral problem is causing it. For example, controlling people have leaking second chakra. To stop the leak, the person needs to stop being controlling. Trying to fix the chakra, by just adding energy to it, would be like trying to fill a vessel with a hole on the bottom. The vessel's hole needs to be mended first, i.e. the energy leak needs to be stopped first, and this requires behavioral changes.

The leak of energy from the second chakra would stop only after efforts have been made to eliminate the controlling behavior. Only after these behavioral changes could Reiki Healer replenish the missing energy, or energy could be added with acupuncture and the health restored.

Enroll in our workshops to learn more about chakras and how to balance them. Please, contact us at: [holicare1@gmail.com](mailto:holicare1@gmail.com)

To get better acquainted with chakras, you can order our books:

1. *Find Your Soul Mate – Secrets of the Soul*
2. *Yoga - Health Benefits, Science, and Wisdom*
3. *Quantum Mind and Quantum Growth - Levels of Spiritual Growth*

We look forward to hear from you.

## REFERENCES RÉFÉRENCES REFERENCIAS

1. M. Kuman, *Same Fields and Dynamics in Stars and Man*, Health and Happiness Book, 2017.
2. M. Kuman, *Yoga - Health Benefits, Science, and Wisdom*, Health and Happiness Book,
3. M. Kuman, *Find Your Soul Mate – Secrets of the Soul*, Health and Happiness Book,
4. V. Tihoplav, T. Tihoplav, *Garmonia Chaosa (the Harmony of the Chaos)*, 2003 (Russ.).
5. A.I. Belkin, V.N. Lakousta, *Biological Therapy of Psychiatric Diseases*, Shtiintza, 1983 (Russ.).
6. *Hormones and Cancer*, 1976.
7. Luce GG, *Biological Rhythms in Psychiatry and Medicine*, 1970.
8. M. Kuman, *Quantum Mind and Quantum Growth - Levels of Spiritual Growth*, Health and Happiness Book, 2015.





This page is intentionally left blank



GLOBAL JOURNAL OF MEDICAL RESEARCH: K  
INTERDISCIPLINARY  
Volume 19 Issue 7 Version 1.0 Year 2019  
Type: Double Blind Peer Reviewed International Research Journal  
Publisher: Global Journals  
Online ISSN: 2249-4618 & Print ISSN: 0975-5888

# Why Does the Merging of the Parents DNAs in a Fertilized Cell Resemble Merging of Two Black Holes? - The Same Turbulent Dynamics

By Prof. Maria Kuman

**Abstract-** The article explains why the observed dynamics of fertilized cell when the parents DNAs fuse resemble merging of two Black Holes. It is because everything in the material world is a material body and NEMF and when two NEMF spinning in opposite direction meet (regardless are these electron and positron, black holes spinning in opposite direction, or spinning in opposite direction male and female DNAs in a fertilized cell), they behave in the same way. The NEMF spinning clockwise as a vortex will suck energy in (because that is what vortices do), will start spinning faster and attract stronger the NEMF spinning in opposite direction. The two NEMF will merge closer, spin around each other before to fuse and then fuse together. Thus, the fact that the whole material world is a material body and NEMF manifest itself in this common dynamic behavior: in the micro world when the spinning in opposite directions NEMFs of electron and positron merge, when the spinning in opposite directions NEMFs of the parents' female and male DNAs merge, and when the spinning in opposite directions NEMFs of two Black Holes merge.

**Keywords:** *merging dynamics at fertilization; merging dynamics of electron and positron; merging dynamics of black holes; same merging dynamics.*

**GJMR-K Classification:** NLMC Code: QU 58.5



*Strictly as per the compliance and regulations of:*



© 2019. Prof. Maria Kuman. This is a research/review paper, distributed under the terms of the Creative Commons Attribution-Noncommercial 3.0 Unported License <http://creativecommons.org/licenses/by-nc/3.0/>), permitting all non commercial use, distribution, and reproduction in any medium, provided the original work is properly cited.

# Why Does the Merging of the Parents DNAs in a Fertilized Cell Resemble Merging of Two Black Holes? – The Same Turbulent Dynamics

Prof. Maria Kuman

**Abstract-** The article explains why the observed dynamics of fertilized cell when the parents DNAs fuse resemble merging of two Black Holes. It is because everything in the material world is a material body and NEMF and when two NEMF spinning in opposite direction meet (regardless are these electron and positron, black holes spinning in opposite direction, or spinning in opposite direction male and female DNAs in a fertilized cell), they behave in the same way. The NEMF spinning clockwise as a vortex will suck energy in (because that is what vortices do), will start spinning faster and attract stronger the NEMF spinning in opposite direction. The two NEMF will merge closer, spin around each other before to fuse and then fuse together. Thus, the fact that the whole material world is a material body and NEMF manifest itself in this common dynamic behavior: in the micro world when the spinning in opposite directions NEMFs of electron and positron merge, when the spinning in opposite directions NEMFs of the parents' female and male DNAs merge, and when the spinning in opposite directions NEMFs of two Black Holes merge.

**Keywords:** merging dynamics at fertilization; merging dynamics of electron and positron; merging dynamics of black holes; same merging dynamics.

## I. INTRODUCTION

Let us introduce some concepts of nonlinear physics, which we would need. The flux of running river-water would be linear, if the bottom of the river is smooth. However, if there is a big stone on the bottom of the river, the water needs to flow around the stone and the water flux becomes nonlinear. Behind the stone,

turbulence would be observed manifested with a couple of: vortex spinning clockwise and anti-vortex spinning counterclockwise.

Following the law of the folded fingers of the right hand in physics, when the folded fingers show the direction of the currents (or direction of spinning), the vertical thumb show the direction of the induced magnetic field. Following this law, the vortices (which spin clockwise) would induce magnetic field toward the surface. This would make the vortices to suck energy in. Following the same law, the anti-vortices (which spin counterclockwise) would induce magnetic field off the surface, which would make the anti-vortices to emit energy.

## II. THE DYNAMICS OF A FERTILIZED CELL WHEN THE PARENTS' DNAs FUSE RESEMBLE MERGING OF ELECTRON AND POSITRON – WHY?

In the last issue of Physics Today of September 2019, Daniel Needleman and Michael Shelly reveal the complexity of the fluid dynamics of living cells. On page 35, they illustrated the monitored with fluorescent microscopy fluid dynamics of a cell after fertilization - the two clumps of parents' DNAs merge toward each other, spin around each other before to fuse (like dancing), and then fuse together [1] (Fig. 1).

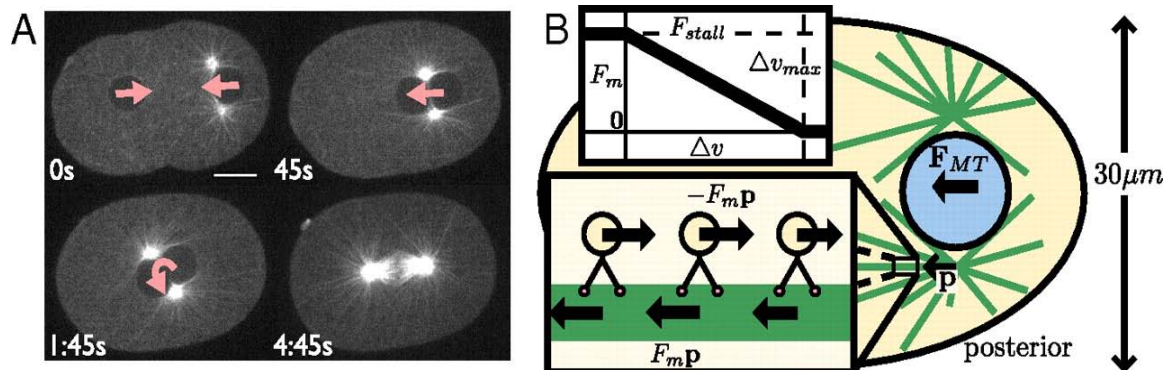

**Fig. 1:** A: In the fertilized cell, the two clumps of spinning in opposite direction mother's and father's DNAs (dark circles) migrate, meet, spin around each other, and fuse at the center of the cell

Author: Ph.D, Holistic Research Institute, 1414 Barcelona Dr., Knoxville, TN 37923, USA. e-mail: [holisticare1@gmail.com](mailto:holisticare1@gmail.com)

The observed dynamics of merging of the mother's and father's DNAs reminded me the observed with LEGO merging of two Black Holes. The mother's and father's DNAs also spin around each other (dance) before to fuse together (Fig. 1) just like two Black Holes do before to merge. At the merging of two Black Holes waves are emitted. I am more than sure that such waves will be emitted when the mother's and father's DNAs merge in a fertilized cell. Scientists just need to find a way to register them.

In the micro world, when electron approaches a positron, the same spinning around each other takes place, after which they fuse together (annihilate) and a gamma quant is emitted. Since at the merging of two Black Holes, which spin around each other before to merge, waves are emitted, I am more than sure that such waves will be emitted when electron and positron merge. Scientists just need to find a way to register them.

After such waves are registered at the merging of mother's and father's DNAs and at the merging of electron and positron, hopefully we will stop calling the waves emitted at merging of two Black Holes gravitational waves and start calling them electromagnetic because as I will explain farther they are electromagnetic waves.

Let see what is the basis of this dancing around each other before to fuse together? Let start with the simplest – the merging of electron and positron. When an electron is knocked out of the space matrix, it spins counterclockwise because only counterclockwise anti-vortices induce magnetic moment outward and create matter. The remaining hole in the space matrix, called positron, spins clockwise like a vortex and the induced by the spinning magnetic field is inward. For this reason, the remaining hole will keep trying to suck back the knocked out electron.

The spinning in opposite directions electron and positron would attract each other because they have opposite magnetic polarity - result of their spinning in opposite direction. Obviously, when two spinning in opposite direction entities meet, they spin around each other (they dance) before to merge together. This is true when the spinning in opposite direction entities are electron and positron and this is true when the spinning in opposite direction entities are mother's and father's DNAs in a fertilized cell.

Are indeed the NEMFs of males' and females' DNAs spinning in opposite directions and how it got to be this way? Let us compare the NEMF of our Sun (Fig. 2), which is androgynous (it is neither male or female), with the NEMF of a human male (Fig. 3). The NEMF of the Sun (Fig. 2) has a torus shape with active turbulent zone in the equatorial area. The turbulence is manifested with two chains of alternating vortices (spinning clockwise) and anti-vortices (spinning counterclockwise). They run on both sides of the

equator and spin in opposite direction in the northern and southern hemisphere.



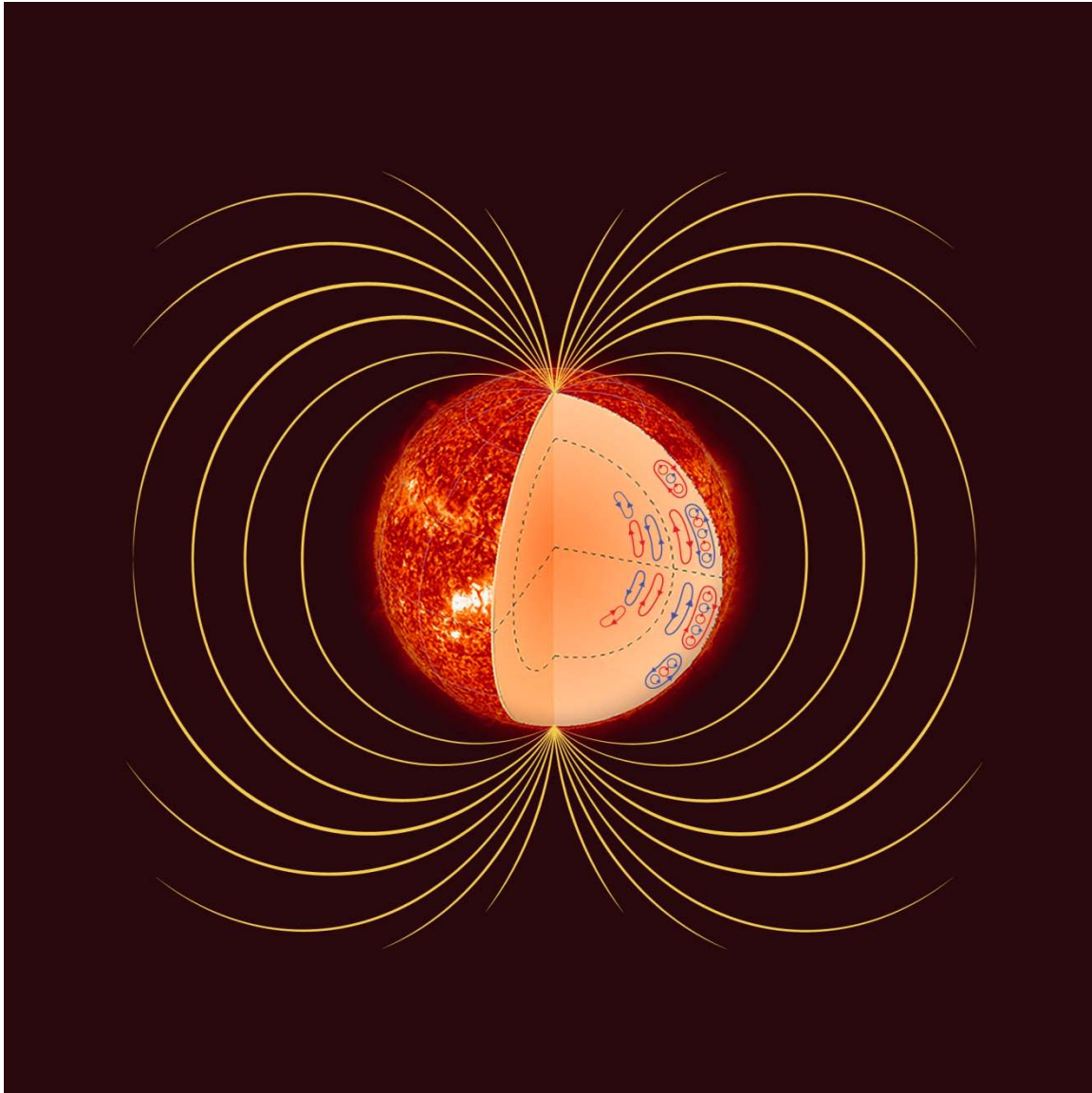

*Fig. 2:* The torus shaped nonlinear electromagnetic field (NEMF) of the Sun



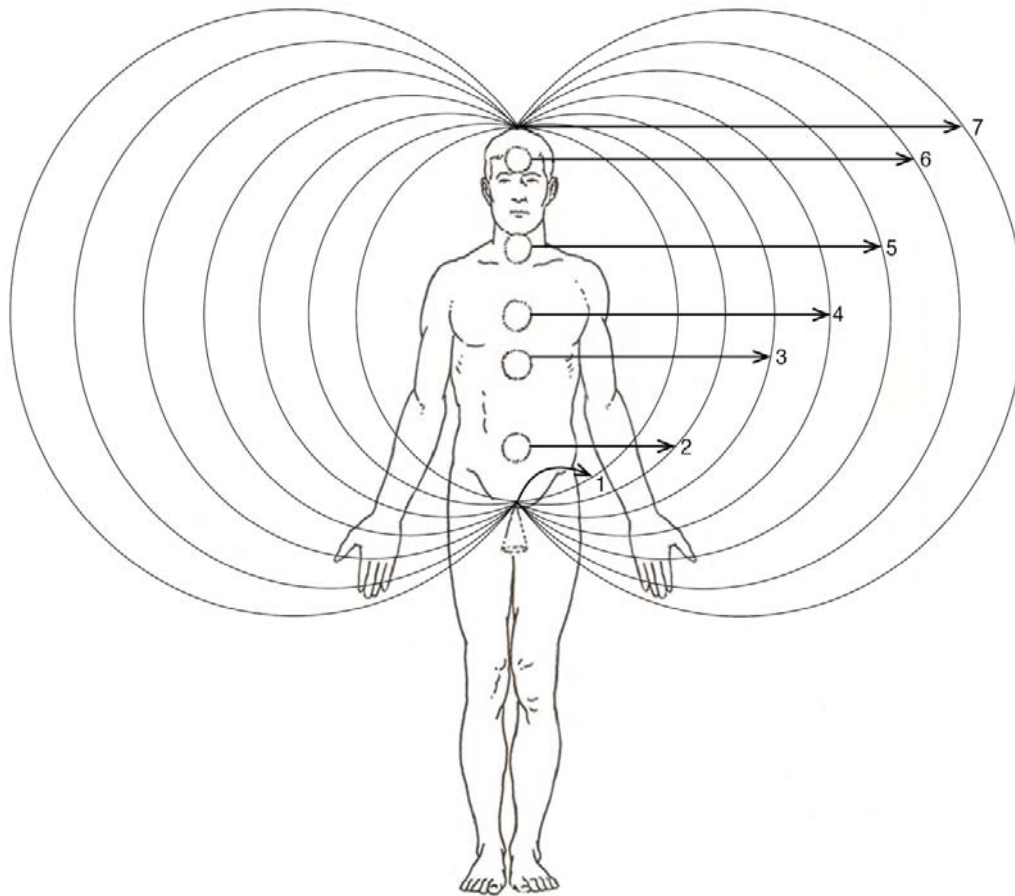

Fig. 3: The torus shaped nonlinear electromagnetic field (NEMF) of a Man

The human NEMF has the same torus shape as the Sun (Fig. 2), but humans' NEMF (man on Fig. 3) have only one chain of alternating vortices and anti-vortices, which is in the middle of the torus (Fig. 3), instead of having two chains running along the equator (Fig. 2) with opposite polarity in the northern and southern hemisphere, as it is in the case of the Sun.

The stars have torus shape androgynous NEMF (Fig. 2) and as explained in [2], they are vortex on top of anti-vortex, which is the basis of their torus shape field. If we would cut the NEMF of the androgynous Sun through the equator and name the southern hemisphere male (Yang) and the northern hemisphere female (Yin), each gender would have one chain of alternating vortices and anti-vortices and they would spin in opposite direction in males and females.

Since the androgynous NEMF is self-organized field, after splitting along the equator, it reshaped into two torus shape fields. Now each of the genders, males and females, had torus shaped NEMF. However, each gender had only one chain of alternating vortices and anti-vortices, which span in opposite direction in males and females, and the chain was in the middle of their reshaped torus-shape NEMFs (Fig. 3).

The opposite direction of spinning of the NEMFs of males and females determines their opposite

magnetic polarities. It seems that the attraction between the genders has magnetic origin. Also, at fertilization of a cell, the opposite spinning of the NEMFs of the mother's and father's DNAs makes them spin around each other (dance) before they merge in the middle of the fertilized cell making it ready for division (Fig. 1).

### III. THE DYNAMIC OF FERTILIZED CELL WHEN THE PARENTS DNAS FUSE RESEMBLE MERGING OF TWO BLACK HOLES – WHY?

In the case of cell fertilization, the spinning in opposite direction NEMFs of the mother's and father's DNAs induced opposite magnetic polarity, which made them spin around each other before to fuse. Just like in the case of fertilization, merging two Black Holes must spin in opposite direction to have opposite magnetic polarity. Then they will attract each other and spin around each other before to merge. At the act of merge waves will be emitted.

Since only counterclockwise-spinning anti-vortices can give birth to matter, obviously the Black Holes at the center of the galaxies spin counterclockwise in the first half of their lifetime when they give birth to the stars of the galaxy, which move

away from them in open trajectories. However, for two Black Holes to merge, they need to have opposite magnetic polarities, which means to spin in opposite direction.

This means that the Black Holes at the center of the galaxies must spin clockwise in the second half of their lifetime. But if the Black Holes spin clockwise like a vortex in the second half of their life, since vortices suck energy, they would suck back the stars. This means that when the stars are old, they are suck back for recycling so that with time a new galaxy in perfect order can be created [2]. This means that the merging astronomy of two Black Holes is an act of recycling the old Black Holes.

#### IV. MATHEMATICAL MODEL DESCRIBING THE DANCE AND THE MERGE

Every perturbation force  $F$  applied to a spinning entity changes its angular velocity  $\omega$

$$\partial\omega/\partial t + \varepsilon F = \partial(\omega + \varepsilon\omega)/\partial t \quad (1)$$

This explains the dancing before merging of the spinning in opposite directions NEMFs of electron and positron, mother's and father's DNAs, or two Black Holes.

The velocity transportation equation is:

$$\partial\omega/\partial t + \nabla \times (\omega \times u) = \nu \nabla^2 \omega + (1/\rho)(\nabla \times (J \times H)), \quad (2)$$

where  $\nu$  is the kinematic viscosity ( $\nu = \mu / \rho$ );  $\rho$  is the density,  $\mu$  - the permeability of the media.

The linearized version of equation (2) is

$$\partial\omega/\partial t = (1/\rho) (H \times \nabla j) + \nu \nabla^2 \omega \quad (3)$$

The same rules and equations apply to merging of the NEMFs of  $e^-$  and  $e^+$  in the micro world, merging of the spinning in opposite direction NEMFs of mother's and father's DNAs in a fertilized cell, and merging in astronomy two Black Holes with NEMFs spinning in opposite directions.

According to nonlinear physics, following the rule of the folded fingers of the right hand (see the Introduction), the NEMF spinning clockwise, as a vortex, at the presence of another entity with NEMF spinning in opposite direction, will suck energy through the hole of its donut shape NEMF and get excited (start spinning faster clockwise). The increased spinning will increase the attraction between the two NEMFs spinning in opposite direction, they will approach each other, spin around each other, and merge.

#### V. CONCLUSION

The article offered explanation of the similar dynamics of merging: of electron and positron in the micro world, of the mother's and father's DNAs in a fertilized cell, and of the merging of two Black Holes in

astronomy. The dynamics is the same because everything in the material world is a material body and NEMF [2]. When two NEMFs with opposite polarity (spinning in opposite direction) meet, they spin around each other before to fuse... and this is true for: merging of the spinning in opposite direction NEMFs of electron and positron in the micro world, merging of two Black Holes spinning in opposite direction in astronomy, and merging of the spinning in opposite direction NEMFs of the mother's and father's DNAs in a fertilized cell.

Since in all three cases electromagnetic fields (NEMFs) spinning in opposite direction merge, the emitted at the merge waves must be electromagnetic waves.

Therefore, the emitted waves at the merging of two Black Holes must be electromagnetic waves, not gravitational waves. Also, electromagnetic waves must be emitted, and should be possible to register, at the merging of the spinning in opposite direction NEMFs of electron and positron and the merging of the spinning in opposite direction NEMFs of the mother's and father's DNAs in a fertilized cell.

#### REFERENCES RÉFÉRENCES REFERENCIAS

1. D. Needleman, M. Shelly, The Stormy Fluid Dynamic of the Living Cell, *Physics Today*, 72 (9): 32, 2019.
2. M. Kuman, How Was the Material World Created? Origin of Its NEMF, *Open Journal of Mathematical and Theoretical Physics*, 2 (2) 2019.
3. M. Kuman, The Key to Health and Happiness – Measurements Show that Not Only Is It Important what You Eat and Drink, It Is Equally Important what You Think, *Current Trends in Biomedical Engineering and Biosciences*, 18 (1) 2019.



This page is intentionally left blank





GLOBAL JOURNAL OF MEDICAL RESEARCH: K  
INTERDISCIPLINARY  
Volume 19 Issue 7 Version 1.0 Year 2019  
Type: Double Blind Peer Reviewed International Research Journal  
Publisher: Global Journals  
Online ISSN: 2249-4618 & Print ISSN: 0975-5888

## Different Healing with Drugs and Alternative Medicine of Males, Females and Transgenders

By Prof. Maria Kuman

*Abstract-* Considering the different response to drugs of males and females, males and females should be tested and treated with drugs differently. Since the drugs influence the material body, the transgenders must be treated according to the type of material body they have. However, in the case of alternative medicine the situation is different. Homeopathic remedies and acupuncture heal through waves – the waves of our nonlinear electromagnetic field (NEMF), which rules and regulates everything in the body from the Subconscious and is different in males and females. Thus, alternative medicine influences the regulating mechanisms, which are gender specific, through the waves of the gender-specific NEMF (called Spirit). Since alternative medicine heals through the waves of the gender specific NEMF, when the transgenders are female Spirit in a male body, they should be treated with alternative medicine according to their Spirit, i.e. as females. The transgenders with male Spirit in their female bodies should be treated with alternative medicine according to their male Spirit (NEMF), i.e. as males. This is so because alternative medicine influences the regulating mechanisms, which the Quantum Computer in the Subconscious handle, and this Quantum Computer operates with the waves of the male or female NEMF (Spirit).

*Keywords:* drugs must be gender specified; drugs for transgenders; alternative medicine for transgenders.

*GJMR-K Classification:* NLMC Code: WA 730



*Strictly as per the compliance and regulations of:*



© 2019. Prof. Maria Kuman. This is a research/review paper, distributed under the terms of the Creative Commons Attribution-Noncommercial 3.0 Unported License <http://creativecommons.org/licenses/by-nc/3.0/>, permitting all non commercial use, distribution, and reproduction in any medium, provided the original work is properly cited.

# Different Healing with Drugs and Alternative Medicine of Males, Females and Transgenders

Prof. Maria Kuman

**Abstract-** Considering the different response to drugs of males and females, males and females should be tested and treated with drugs differently. Since the drugs influence the material body, the transgenders must be treated according to the type of material body they have. However, in the case of alternative medicine the situation is different. Homeopathic remedies and acupuncture heal through waves – the waves of our nonlinear electromagnetic field (NEMF), which rules and regulates everything in the body from the Subconscious and is different in males and females. Thus, alternative medicine influences the regulating mechanisms, which are gender specific, through the waves of the gender-specific NEMF (called Spirit). Since alternative medicine heals through the waves of the gender specific NEMF, when the transgenders are female Spirit in a male body, they should be treated with alternative medicine according to their Spirit, i.e. as females. The transgenders with male Spirit in their female bodies should be treated with alternative medicine according to their male Spirit (NEMF), i.e. as males. This is so because alternative medicine influences the regulating mechanisms, which the Quantum Computer in the Subconscious handle, and this Quantum Computer operates with the waves of the male or female NEMF (Spirit).

**Keywords:** *drugs must be gender specified; drugs for transgenders; alternative medicine for transgenders.*

## I. DIFFERENT DRUG RESPONSE OF MALES AND FEMALES

Since the hormonal balance is different in males and females, it can be expected that their neurotransmitters' balance would be different. Indeed, it was found that males and females have different number cholinergic neurons, which release the neurotransmitter acetylcholine. Enters et al. [1] first found these gender differences in cholinergic neurons in 1990.

If the hormonal and neurotransmitters' balances are different in males and females, we can expect gender differences in drug response. Methadone is a potent narcotic analgesic drug administered by mouth or injection to relieve severe pain or suppress coughs. Not only was it found that the response of males and females to the drug is different, it was found that when administered to pregnant women, it changes the neurotransmitters' balance in the fetus' brain.

Ageel et al. [2] found gender differences in response to desipramine, which is a cyclic anti-depressant. More females responded to the drug with conditioned avoidance than males. The list of different drug response of males and females is long and it means that each drug should be tested separately on males and females.

Gender differences were also found in the response to MDMA, known under the name "ecstasy". From experiments with animals it is known that MDMA is neurotoxic to serotonin neurons, which release serotonin at negative emotions. If so, the depressed people, who need "ecstasy" to perk up, must be dominant negative thinkers [3].

*Author: Ph.D, Holistic Research Institute, 1414 Barcelona Dr., Knoxville, TN 37923, USA. e-mails: holisticare1@gmail.com, www.mariakuman.com*

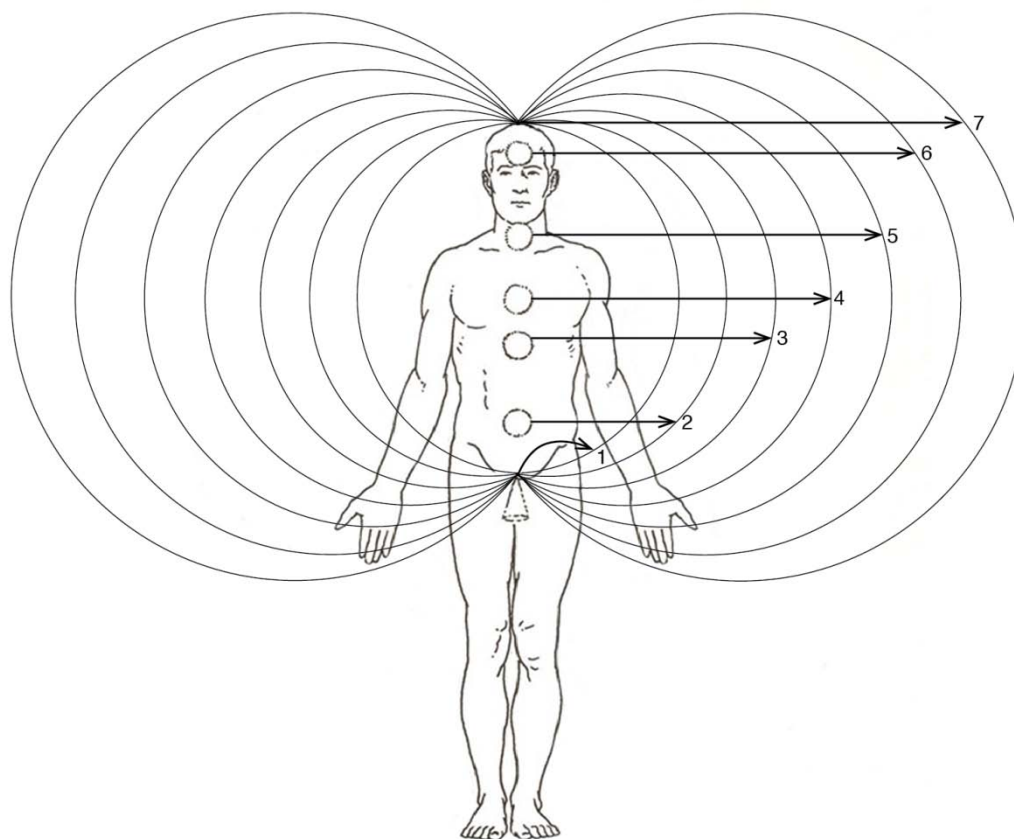

Fig. 1: Vertical cross-section of male NEMF

These negative thinkers should change their way of thinking from negative to positive instead of being driven to ecstasy to perk up and getting addicted to it. The mental disorder ostracism is also related to negative thinking and high serotonin levels, which differ for males and females [3].

## II. NEMF SPINS IN OPPOSITE DIRECTION IN MALES AND FEMALES

Each one of us has nonlinear electromagnetic field (NEMF) with a shape of a donut spinning around the axis passing through the hole of the donut, which is along the backbone (Fig. 1). It is seen as aura, but the donut-shaped field spins in opposite directions in males and females.

For each gender, the spinning turns to the opposite at dawn and dusk, but it always remains opposite in males and females. Since spinning in opposite direction creates magnetism with opposite polarity, obviously the attraction between the opposite sexes is magnetic in origin. Curiously, my mother called the attraction between the opposite sexes magnetism.

## III. WHERE THE TRANSGENDERS BELONG?

If the attraction between the opposite sexes is magnetic in origin and some men are attracted to men,

these men must have NEMF spinning as a female NEMF. Since our NEMF is our Spirit [4], this means that these men have a male body, but female Spirit and this is exactly the way they explain their tragedy – they feel like a female Spirit locked in a male body.

Thus, the transgenders are female Spirit locked in a male body or vice-versa male Spirit locked in a female body. One way or another, the transgenders are here to tell us that we are body and Spirit. In the normal situation when female Spirit inhabits female body and male Spirit inhabits male body, we cannot see that we are body and Spirit.

Thanks transgenders for opening our eyes to the fact that we are body and Spirit and this Spirit is nonlinear electromagnetic field (NEMF). The Subconscious is the place, where this field is located (that is why we don't have conscious awareness of its existence), and its waves are the basis of the Quantum Computer, which rules and regulates everything in the body.

Homeopathic remedies are so diluted that substance is not present any more. If so, homeopathic remedies must work through the frequencies of the substance, which were imprinted on the many times shaken and then diluted again water [5]. Shaking must increase the memorizing abilities of water because it frees H-bonds [5] and the memorized frequencies must

heal through the Quantum Computer in the Subconscious working with the waves of our NEMF.

Our book *Modern Aspects of Ancient Acupuncture* [6] is the only book that explains how acupuncture works. We predicted with a mathematical model in 1983 [7] that waves must run along the acupuncture meridians when an acupuncture point is punctured with a needle. This was experimentally confirmed in 1984 [8] and it means that acupuncture cures with the waves of our NEMF (our Spirit), which are the basis of the operating in the Subconscious Quantum Computer.

If the alternative medicine (homeopathy and acupuncture) heals through waves and these are the waves of our NEMF called Spirit:

1. The transgenders with female Spirit in their male bodies must be treated with Alternative Medicine as females according to their Spirits, and not according to their male bodies.
2. The transgenders with male Spirit in their female body must be treated with Alternative Medicine as males according to their Spirits, and not according to their bodies.

The waves of our NEMF are also the basis of our fast response [9]. Should our life depend only on the nervous system, which is very slow, we would be dead long time ago. Our Quantum Computer in the Subconscious is also the basis of our intuitive creativity [10] and our distant telecommunications called telepathy.

#### IV. CONCLUSION

Since the drugs heal by changing the biochemical balance of the body, the transgenders with female Spirit in male bodies must be treated with drugs as their bodies are, i.e. as males. The transgenders with male Spirit in their female body must be treated with drugs as their bodies are, i.e. as females.

However, the situation is reversed in the case of alternative medicine. Since in alternative medicine like homeopathic remedies, the solution is so dissolve that there is no substance left, the healing is done with the frequencies of the dissolved substance. It is done through the Quantum Computer in the Subconscious [11], which operates with waves the NEMF (called Spirit).

The same is true for acupuncture. Since we have the proof that waves are involved in every acupuncture treatment [6], [7], [8], acupuncture obviously heals with waves. This means that acupuncture heals through the Quantum Computer, which operates with the waves of our NEMF (called Spirit), and from the Subconscious rules and regulates everything.

If so, transgenders with female Spirit, who are females in male bodies, should respond to alternative

medicine as their female Spirit. Regardless that their body is male, they should be treated with alternative medicine as females. Transgenders with male Spirit, who are males in female bodies, should respond to alternative medicine as their male Spirits. Regardless that their body is female, they should be treated with alternative medicine as males.

#### REFERENCES RÉFÉRENCES REFERENCIAS

1. Enters EK et al, Development Brain Research, 57 (2) 1990.
2. Ageel AM, Ginawi OT, Research Communications in Psychology, Psychiatry and Behavior, 13 (4) 1988.
3. Kuman M, The Differences – Male and Female – and How to Benefit from Them, Health and Happiness Books, 1998.
4. Kuman M, Research in Medicine and Engineering Sciences, 5 (3) 2018.
5. Kuman M, How Homeopathy Heals, International Journal of Complimentary and Alternative Medicine, 12 (1) 2019.
6. Kuman M, Modern Aspects of Ancient Acupuncture, Health and Happiness Books, 19
7. Kuman M, 8<sup>th</sup> World Congress on Acupuncture, Sofia, Bulgaria, 1983.
8. Eory A, Acupuncture and Electro-Therapeutic Research 9 (9) 1984.
9. Kuman M, Acupuncture and Electro-Therapeutic Research, 42 (3-4) 2017.
10. Kuman M, Journal of Proteomics and Bioinformatics, 7 (5) 2018.
11. Kuman M, International Journal of Complimentary and Alternative Medicine, 12 (1) 2019.



This page is intentionally left blank





GLOBAL JOURNAL OF MEDICAL RESEARCH: K  
INTERDISCIPLINARY  
Volume 19 Issue 7 Version 1.0 Year 2019  
Type: Double Blind Peer Reviewed International Research Journal  
Publisher: Global Journals  
Online ISSN: 2249-4618 & Print ISSN: 0975-5888

## Science for the Effect of Prayer

By Prof. Maria Kuman

*Abstract-* The Russian professor Slezin wrote: “Before our findings, the science knew three states of the Conscious: awaken state and slow and fast sleep, which differ by the character of their electric impulses. Now, we know about one more state – total switch off of the electrical activity on the brain surface during prayer while the person is totally conscious”. Mahatma Gandhi warned: “Prayer is not the holiday entertainment of old ladies. When used right, it is the most powerful instrument of action”.

*Keywords:* prayer; effects of prayer; science and prayer; measuring effects of prayer.

*GJMR-K Classification:* NLMC Code: QT 162.S8



*Strictly as per the compliance and regulations of:*



© 2019. Prof. Maria Kuman. This is a research/review paper, distributed under the terms of the Creative Commons Attribution-Noncommercial 3.0 Unported License (<http://creativecommons.org/licenses/by-nc/3.0/>), permitting all non commercial use, distribution, and reproduction in any medium, provided the original work is properly cited.

# Science for the Effect of Prayer

Prof. Maria Kuman

**Abstract-** The Russian professor Slezin wrote: *"Before our findings, the science knew three states of the Conscious: awoken state and slow and fast sleep, which differ by the character of their electric impulses. Now, we know about one more state – total switch off of the electrical activity on the brain surface during prayer while the person is totally conscious".* Mahatma Gandhi warned: *"Prayer is not the holiday entertainment of old ladies. When used right, it is the most powerful instrument of action".*

**Keywords:** prayer; effects of prayer; science and prayer; measuring effects of prayer.

## I. INTRODUCTION

“ In the beginning was the word and the word was with God and the word was God” (Christian Bible, John 1:1). “Word” means “Information”, so *Information was at the basis of all Creation*. So, information imprinted by the Creator God created the whole material world. What kind of information was this? The information needed to be nonlinear not to dissipate and to be able to pass, if necessary, through screens and other obstacles [1], [2].

If so, the whole material world is “matter + Spirit” and the Spirit is this nonlinear informational field that created the whole material world [1], [2]. Since our material body is mostly water, the water should be able to imprint information, and this is the message Masaru Emoto delivers in his book: *The Secrets Messages of Water*. “The words have their individual and unique vibrational frequencies” and these vibrational frequencies can be imprinted on the structure of water [3].

Emoto found that the word “Love” makes the liquid water crystalize in very pretty symmetric ice forms, while the word “hatred” makes the liquid water crystalize in ugly asymmetric ice forms [3]. In the human material body, the nonlinear informational field – the informational program that created the body – is located in the Subconscious. If so, we don’t have conscious awareness of it, but from the Subconscious it continues to rule and regulate everything in the material body.

This nonlinear informational field called Spirit is weak, but very important field. It is 1,000 times weaker than the biocurrents of the material body. Since our science does not have sensitive enough equipment to measure it, our science denies its existence - we are only a material body, there is no Spirit. The author of this article had to develop and patent supersensitive

equipment capable to measure this weak but very important nonlinear electromagnetic field (NEMF) [4].

Then the author of this article spent almost 40 years of her life measuring this weak NEMF, called Spirit, which rules and regulates everything in the material body from the Subconscious. The waves of this NEMF are the basis of our powerful Quantum Computer - it calculates 10,000 times faster (known from hypnosis, which put the conscious to sleep to access the subconscious) and house the whole life memory storage (also known from hypnosis). From the Subconscious, this powerful Quantum Computer rules and regulates everything in the material body, and carries our superb Mind.

If information or words were the basis of creation of the whole material world, words should be able to reach and activate our Quantum Computer working with the waves of our Spirit (the NEMF). This could explain how verbal prayer works and why it works. Russian studies [5] found that during verbal prayer our Conscious, which is our Digital Computer, is shut off (just like during hypnosis and during meditation). Obviously, this is necessary so that the Quantum Computer of our Subconscious can be accessed and activated. Hope this explains what Mahatma Gandhi said: “Prayer is the most powerful instrument in action.”

## II. SCIENTIFIC STUDIES REVEALING THE POWER OF PRAYER

Since information or words, which were vibrations, were imprinted to create the material world, IR spectra, which register vibrations, were used to make visible the effect of prayer. Russian scientists did comparative analysis of the IR spectra of the blood of patients and healthy individuals before and after prayer. Fig. 1 shows the effect of prayer on a healthy individual [5].

Fig. 1a shows the vibrational frequencies specific for the immune system of a healthy individual, who was a strong believer. Fig. 1b shows the changes in the immune system of this healthy individual after prayer. Obviously, the prayer mobilizes the immune system of the sick individual, by switching on internal reserves, which lead to self-correction and restoration of the lost health [5].

The Russian scientists also found that just prayer is capable to increase the life energy of the patient up to 100 times. They also found that prayer always increases the vibrations of the praying person to higher frequencies, which brings him closer to the

**Author:** Ph.D, Holistic Research Institute, 1414 Barcelona Dr., Knoxville, TN 37923, USA. e-mails: [holisticare1@gmail.com](mailto:holisticare1@gmail.com), [www.mariakuman.com](http://www.mariakuman.com)

frequencies of his Creator-Spirit (and this brings the healing) [5].

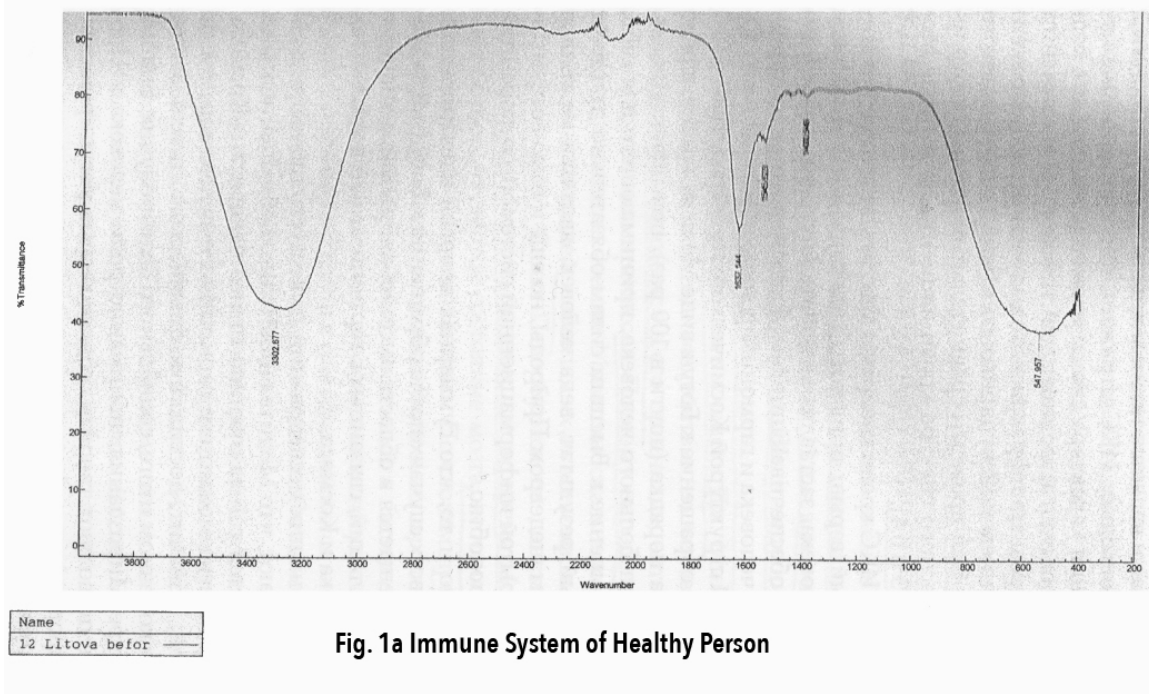

**Fig. 1a Immune System of Healthy Person**

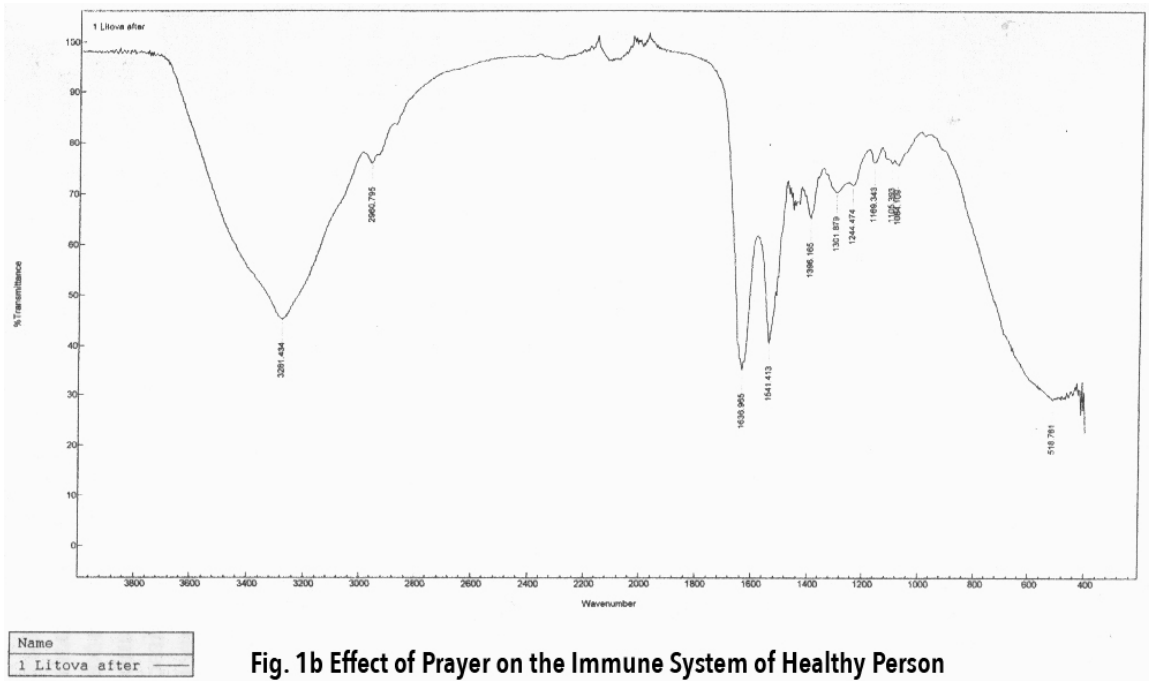

**Fig. 1b Effect of Prayer on the Immune System of Healthy Person**

The Russian scientists colored different blood cells with different colors to determine how prayer changes the blood content. The results before and after prayer are presented on Fig. 2. Prayer increased the natural defense of the cells and their balance (PLT) and the mean platelets volume (MPV). This speaks of balanced sympathetic and parasympathetic nervous systems [5]. Thus, prayer seems to be restoring the balance of the sympathetic and parasympathetic nervous systems, which were imbalanced by stress.

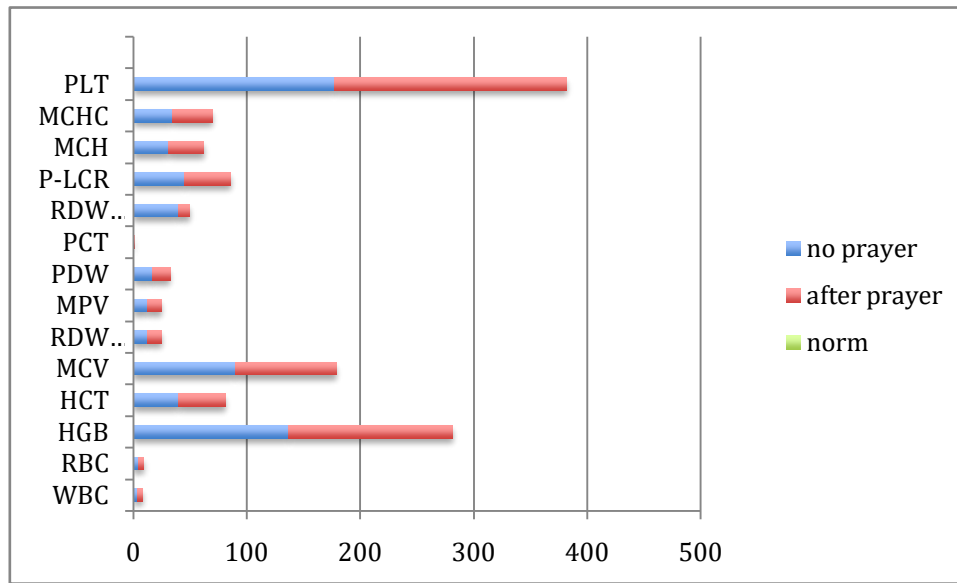

Fig. 2

It was also found in Russia that when a person is under stress, first the intercellular space responds with changes - its elasticity decreases and formations similar to "monetary stacks" are formed [5], which later leads to inability of the cells to communicate. In a cut wound, the separated cells dedifferentiate to be able to multiply fast and heal the wound fast, but in the case of cancer there is no current of regrowth to guide the cellular growth and the cells start multiplying senselessly, which we call malignancy. This is how stress causes cancer [6], [7], [8].

The formation of these "monetary stacks" between the cells, which makes the normal communication among the cells impossible and leads to malignancy explains the strange observed fact that if somebody is sick with very high body temperature, he is immuned against cancer for the next five years. Probably, the very high body temperature melts the "monetary stacks" in the intercellular space between the cells and normalizes their communication.

If stress destroys the balance between the sympathetic and parasympathetic nervous systems and prayer seems to be restoring their balance, this could explain how prayer helps cancerous patients to recover. Obviously, as prayer rebalances the sympathetic and parasympathetic nervous systems, the "monetary stacks" disappear, the intercellular communication is restored, and the cancer is cured. It may help imagining or visualizing during prayer how the "monetary stacks" between the cells melt and the normal communication among the cells is restored.

Since in the last two centuries the yearly increase of cancer has grown tremendously, early detection and treatment became necessity. In Russia, a way was found to early detect cancer with measurements of the frequencies of the fine field energy

(NEMF) (Fig. 3) [5] or measuring the dissipation energy in the cells. Also, a way was found to early treat and prevent cancer by applying to the intercellular space appropriate fine-field wave information [5]. (Details were not given).

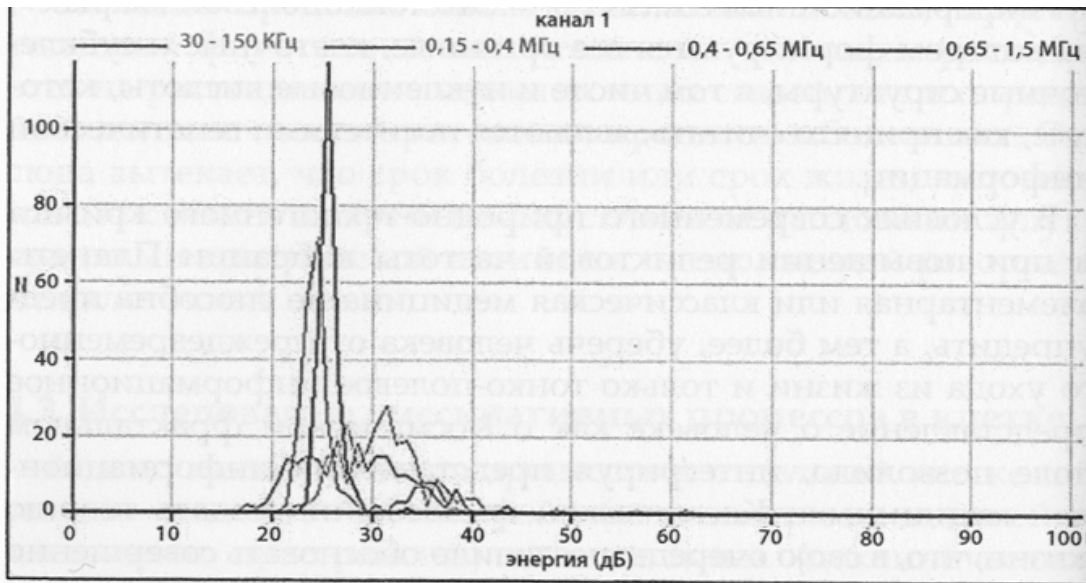

**Fig. 3a Histogram of energy distribution by frequency of a healthy person.**

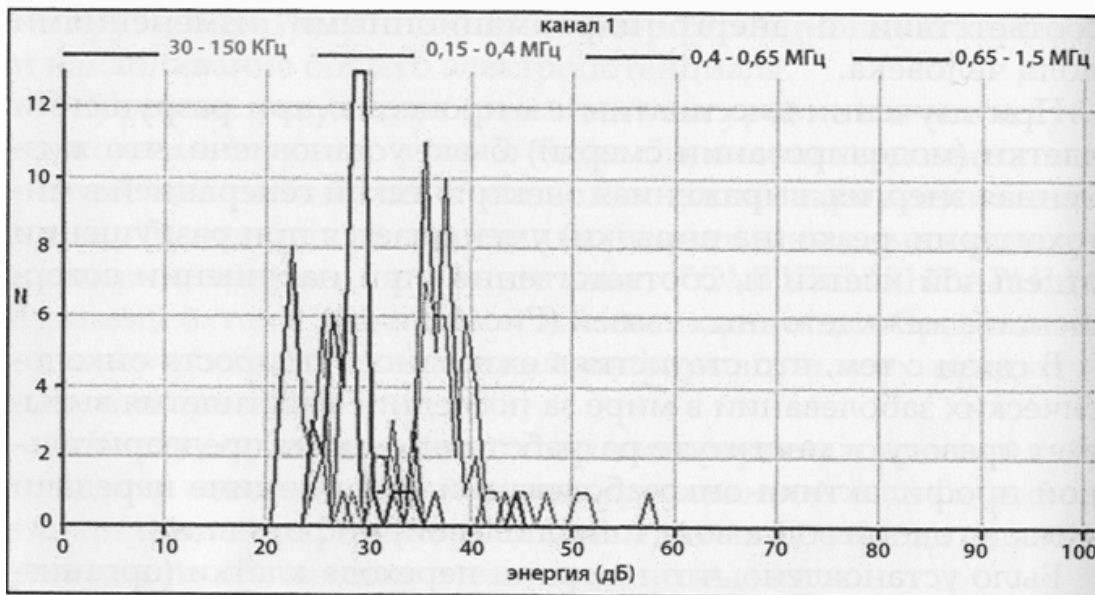

**Fig. 3b Histogram of energy distribution by frequency of a person with cancer.**

Prayer also seems to increase the hemoglobin level, which increases the supply of oxygen to life-important organs and systems [5]. Also, analysis of the IR spectra of the blood showed that after prayer the absorption peaks are much less because the peaks of bronchial inflammation and the tension in the heart area were not there any more. After prayer, also disappeared

the peaks related to disturbed blood supply to the brain [5].

While before prayer the heart of a patient with heart troubles had 66 beats per min, after the prayer the beats were 74 per min. Also while before prayer ECG showed disturbed metabolism in three places: the heart zone behind the diaphragm, upper zone, and front-side,



7 days after the prayer, disturbed was only the metabolism in the zone behind the diaphragm [5].

### III. CONCLUSION

Prayer is a verbal (informational) approach to our Quantum super-computer, which works with the waves of our NEMF and from the Subconscious rules and regulates everything in the body. For this reason, prayer has global influence over the whole body. It influences the immune system and can change the blood content and the blood circulation, the heart, the blood supply to the brain, etc.

Stress destroys the balance between the sympathetic and parasympathetic nervous system. It was found that stress causes cancer by forming "monetary stacks" formations in the intercellular space, which make the communication between the cells impossible.

The cells become disconnected like they are in a cut wound. They dedifferentiate to be able to multiply fast and heal the wound fast, but in the case of cancer there is no wound to heal and no current of regrowth to guide the cells as it would be in a cut wound, and they multiply senselessly. We call this malignancy.

Prayer was found to be able to rebalance the sympathetic and parasympathetic nervous systems, which eliminates the "monetary stacks" between the cells and restore the normal communication between them. This is how the prayer helps cancer patients.

The article also delivers information how to early detect cancer by measuring the dissipation energy distribution by frequencies. Cancer patients were found to have frequency emission in the 0.15 – 0.4 MHz region, which healthy people do not have. This makes me think that probably the presence of "monetary stacks" in the intercellular space is the source of these frequencies.

The article also reported the Russians have found ways to destroy the "monetary stacks" by applying to the intercellular space appropriate fine-field wave information [5]. More details were not given in the Russian source.

### REFERENCES RÉFÉRENCES REFERENCIAS

1. Kuman M, Same Fields and Dynamics in Stars and Man, Health and Happiness Books, 2017.
2. Kuman M, How the Material World Was Created? Origin of its NEMF, Journal of Mathematics and Theoretical Physics, 2 (2) 2019.
3. Emoto M, The Secrets Messages of Water, Kyoto, 2012.
4. Kuman M, Acupuncture and Electro-Therapeutic Research, 42 (3-4) 2017.
5. Maslov L. I., Kirpichnikova I. M., Informational-Energy Medicine of the Future, Book XIII, Moscow, 2016 (Russ.).

6. Kuman M. What Everybody Needs to Know about Chronic Pain, Chronic Diseases and Cancer, Health and Happiness Books, 1993.
7. Kuman M, Advanced Complimentary and Alternative Medicine, 1 (4) 2018.
8. Kuman M, International Journal of Complimentary and Alternative Medicine 11 (6) 2018.



This page is intentionally left blank



GLOBAL JOURNAL OF MEDICAL RESEARCH: K  
INTERDISCIPLINARY  
Volume 19 Issue 7 Version 1.0 Year 2019  
Type: Double Blind Peer Reviewed International Research Journal  
Publisher: Global Journals  
Online ISSN: 2249-4618 & Print ISSN: 0975-5888

# Computerized Acupuncture for Prevention of Chronic Diseases

By Prof. Maria Kuman

*Abstract-* This article explains the nature of chronic diseases, the mechanism of their onset by stress, and how acupuncture cures them. Stress causes different delays in different biorhythms. These delays (phase shifts) accumulate in the genetically weak organ, which does not have enough energy to propel them. This creates chronological disorder in its biorhythms, which manifests as functional (chronic) disease of the organ. Since the phase-shift accumulation is a slow process, the onset of chronic diseases takes 5 to 7 years ('chronic' means 'slow'). Acupuncture cure chronic diseases through accumulation of the stimulation effect of a series of 14 to 20 daily treatments, which restore the biorhythms' order of the sick organ. However, the cure is slow and unpredictable by nature (because more than one series of treatments might be necessary). For that reason, the right approach to chronic diseases would be prevention and their slow onset leaves us plenty of time for this. The ancient pulse diagnosis, which is still practiced in Asia, is a powerful technique for early detection of minor imbalances, which can be eliminated with just one acupuncture treatment.

*Keywords:* acupuncture, chronic diseases, cure of chronic diseases, prevention of chronic diseases, computerized acupuncture for prevention.

*GJMR-K Classification:* NLMC Code: WS 210



Strictly as per the compliance and regulations of:



© 2019. Prof. Maria Kuman. This is a research/review paper, distributed under the terms of the Creative Commons Attribution-Noncommercial 3.0 Unported License <http://creativecommons.org/licenses/by-nc/3.0/>), permitting all non commercial use, distribution, and reproduction in any medium, provided the original work is properly cited.

# Computerized Acupuncture for Prevention of Chronic Diseases

Prof. Maria Kuman

**Abstract-** This article explains the nature of chronic diseases, the mechanism of their onset by stress, and how acupuncture cures them. Stress causes different delays in different biorhythms. These delays (phase shifts) accumulate in the genetically weak organ, which does not have enough energy to propel them. This creates chronological disorder in its biorhythms, which manifests as functional (chronic) disease of the organ. Since the phase-shift accumulation is a slow process, the onset of chronic diseases takes 5 to 7 years ('chronic' means 'slow'). Acupuncture cure chronic diseases through accumulation of the stimulation effect of a series of 14 to 20 daily treatments, which restore the biorhythms' order of the sick organ. However, the cure is slow and unpredictable by nature (because more than one series of treatments might be necessary). For that reason, the right approach to chronic diseases would be prevention and their slow onset leaves us plenty of time for this. The ancient pulse diagnosis, which is still practiced in Asia, is a powerful technique for early detection of minor imbalances, which can be eliminated with just one acupuncture treatment. In modern times, the best approach to chronic diseases would be computerized acupuncture, which monitors the imbalances and eliminates them with computer guided treatment as soon as they appear.

**Keywords:** acupuncture, chronic diseases, cure of chronic diseases, prevention of chronic diseases, computerized acupuncture for prevention.

## I. CHRONIC DISEASE OF AN ORGAN MEANS STRESS-INDUCED CHRONOLOGICAL DISORDER OF BIORHYTHMS

Our body is a self-organized system (Prigogine, 1984) [1]. According to a book of H. Haken (1978) [2] § 7.2: "Self-organization can be described only if the external forces are included as parts of the described system ... and external forces are variables in the equation of evolution." Hence, for description of the dynamic of onset or cure of stress-induced diseases, we will need an evolution equation, which will include the external forces (in our case stressors) as variables.

Stress induces delays because the body needs to stop whatever it was doing at the moment and mobilize for response to the stressor. For the periodic chemical reactions in the body called biorhythms, these delays are called phase shifts. Experiments show that different biorhythms are phase shifted in a different way [3]. Since the biorhythms of the genetically weak organ are weakly integrated, stress disorders them first. As a

result, the organ starts to malfunction or suffers chronic disease (G.G. Luce, 1970) [3].

The survival of our body depends on its ability to adapt. The more flexible and plastic is the biorhythm organization at all three levels: body, organs, and cells, the better would be the adaptation and the survival. To manifest such plasticity, the biorhythms need to be nonlinearly related and they are. But regardless how plastic the biorhythms' organization is, strong or prolonged stress could surpass the ultimate level, which the genetically weak organ can tolerate, and destroy the harmony of its biorhythms. (Prolonged stress means a series of stressors acting on the body within short time intervals, which allows the effects of stress to accumulate.)

The organ with disordered biorhythms would try to evolve to a state with new biorhythm order. However, in the new state the biorhythms would be more poorly associated because some energy has been used to mobilize for respond to the stressors. The more poorly associated biorhythms would make the organ better adapted to stressful environment, but its functioning would be sluggish; the organ will suffer functional or chronic disease.

## II. THE DYNAMIC OF ONSET AND CURE OF CHRONIC DISEASES CAN BE BEST DESCRIBED BY THE NON-EQUILIBRIUM THEORY OF PRIGOGINE

The nonequilibrium theory of Prigogine [1] is the only theory that can explain the dynamic of onset and cure of chronic diseases and to explain why the cure of chronic diseases is difficult and unpredictable. According to the nonequilibrium theory, strong or prolonged force can drag a system very far from equilibrium to a stable far-from-equilibrium state (FES) with a deep energetic minimum and a new type of order.

Thus, each chronic disease, which is a result of strong or prolonged stress, is a stable far-from-equilibrium state with lower energy and new type of biorhythm order. According to the non-equilibrium theory (Prigogine, 1984) [1], it is difficult to drag a system out of a far-from-equilibrium state. Since it took time to reach the state of chronic disease, it would take time and efforts to cure the chronic disease. For this reason the cure of chronic diseases is difficult.

**Author:** Ph.D, Holistic Research Institute, 1414 Barcelona Dr., Knoxville, TN 37923, USA. e-mail: [holisticare1@gmail.com](mailto:holisticare1@gmail.com)

The cure of chronic diseases is also unpredictable because the far-from equilibrium state of chronic disease has a new type of biorhythm order and leaving this state requires reordering. Since reordering is a state with chaotic nature, the outcome is unpredictable, which makes the cure of chronic diseases unpredictable. *Thus, if one series of acupuncture treatments didn't cure the chronic disease, the acupuncturists shouldn't be blamed for this because the cure of chronic diseases is unpredictable by nature.*

### III. NONLINEAR MATHEMATICAL MODEL

Considering the nonlinear connection of the biorhythms, the following nonlinear differential equation was offered for description of the phase-shift changes induced by stress.

$$J_i \omega_i' + D_i \omega_i + \sum d_{ij} (\omega_i - \omega_j) + \sum K_{ij} \cos \theta_{ij} = \sum E_{ij} = E \tag{1}$$

$\omega_i' = d\omega_i/dt$ ,  $\omega_i = d\theta_i/dt$  was the frequency of the phase shift changes,  $J_i$  - inertial coefficient,  $D_i$  - coefficient of self-calming,  $d_{ij}$  - coefficient of mutual effect of calming,  $E_{ij}$  - "energy" coefficient, which reflects the energy of integration of the biorhythms. It varies from individual to individual and decreases with aging. Since the decrease with aging is slow, for a limited period of time  $E_{ij}$  can be considered a constant.

Let us assume that prolonged stress through a series of stressors acting through small time intervals has disordered the biorhythms of the genetically inherited weak organ (through the delays each stressor creates) and the organ has drifted to a state of chronic disease. The only way to cure the chronic disease is to use a series of daily acupuncture treatments. These acupuncture treatments are mild stressors, which would stimulate or add energy to the organ (Kuman, 1985) [4], and when done daily, their effect would accumulate. This would restore the health of the organ, i.e. cure the chronic disease.

Every mild stressor  $i$  (like acupuncture treatment) stimulates the body, i.e. adds to the energy of the biorhythm integration  $E_{oi}$  energy  $\Delta E_{oi}$ . After a series of acupuncture treatments the equation of evolution will be

$$J_i \omega_i' + D_i \omega_i + \sum d_{ij} (\omega_i - \omega_j) + \sum K_{ij} \cos \theta_{ij} = \sum E_{ij} = E_i + \Delta E_{oi} - E_i$$

Since Hans Selye, who is considered the Father of Stress, claims that the energy recharge is never full, there is always a deficit of energy. To consider these inevitable losses, we have subtracted a term  $E_i$  (index  $i$  stands for losses, which means not full recharge).

The change in the energy of biorhythm integration  $\Delta E_i$  under the influence of a mild stressor  $i$  will be proportional to the initial energy of biorhythm integration  $E_i$  with coefficient of proportionality  $\mu_i$

$$\Delta E_i = \mu_i E_i$$

Research shows that when disturbed by stressors different biorhythms need different time to go back to norm (see Luce, 1970, p. 135-138) [3]. Hence,

$$\Delta E_i = \mu_i E_i = T_{oi} dE_i/dt.$$

$T_{oi}$  is the time a biorhythm needs to react to a stressor, which is different for different biorhythms.

In order to adequately describe the effect of prolonged stress as accumulation of the effect of a series of stressors (acting through relatively short time intervals), we have to postulate a nonlinear equation of the type

$$T_{\omega_i} d\mu/dt = s(s+1)\mu + u_i,$$

Where  $u_i$  is an external governing signal and the term  $s(s+1)$  reflects the nonlinear accumulation of the stressors' effect with time.

When speaking about stability of a system of biorhythms, the first important question is: if the stability is lost (or is close to being lost), how should the external governing signal  $u_i$  be modulated to assure stability of the system again?

From the Lyapounov's conditions for stability [7] one can get:

$$u_i = -k_{pi} [ \partial V / \partial \omega_i + T_i d/dt ( \partial V / \partial \omega_i ) ] - \beta_i ( \Delta E_i + k_{pi} \partial V / \partial t )$$

$k_{pi}$  and  $\beta_i$  are positive numbers reflecting amplitude changes of the pulse of the diseased organ found with the traditional Chinese pulse diagnostics.

Taking the "potential" in the simplest possible quadratic form

$$V = \sum [ (1/2) \omega_i^2 + r_{c,i} \omega_i \theta_i + (1/2) \delta_i^2 ],$$

One can get for the external governing signal the expression:

$$u_i = k_{pi} ( \omega_i + r_{c,i} \theta_i + T_i ( d\omega_i/dt + r_{c,i} \omega_i ) ) - \beta_i [ \Delta E_i + k_{pi} ( \omega_i + r_{c,i} \delta_i ) ]$$

The last expression means that we must monitor all the time the phase shift changes, which induce amplitude changes in the measured pulse in pulsed diagnostic (Kuman, 1984) [5]. When the critical point  $\Delta\theta_c$  is reached (or is close to being reached), the system becomes instable and is characterized by large amplitude changes. This indicates that the system of biorhythms is close to losing stability. Then we should try (through acupuncture needles or any other mild stressor) to change the phase-shift parameters  $\theta_i$ ,  $\omega_i$ ,  $k_{pi}$ ,  $r_{c,i}$ ,  $T_i$ ,  $\beta_i$  in such a way that the governing signal  $u_i$  could restore the stability of the system.



#### IV. WHY SHOULD ACUPUNCTURE BE USED TO PREVENT CHRONIC DISEASES?

Since the cure of chronic diseases is difficult and unpredictable, we should do our best to prevent the oncoming chronic disease. Prevention is the only way to secure success in the cure of chronic diseases. What we offer here as preventive measure is to monitor certain body parameters: biorhythm phase shifts  $\theta_j$  and the dynamic of their changes with time  $\omega_j$  and  $d\omega_j/dt$ , the biorhythm's amplitudes and their changes  $k_{pi}$  and  $\beta_i$ , etc., and to be able to foresee the moment of biorhythm de-synchronization.

By using a suitable mild stressor such as acupuncture treatment, we could change these parameters and prevent the biorhythm de-synchronization, or in other words prevent the oncoming chronic disease. *Any mild stressor, such as mild laser, mild electric current, light, magnets, etc., could be used with the same success for the same purpose - to restore the balance destroyed by stress, or prevent the chronic disease.*

Mathematical modeling of Tikashi Nishikawa and Edward Ott [6] showed with simulation and analytically that if the system is influenced before reaching the threshold called bifurcation, a small push (just a few times larger than the noise level) has 90% chances to prevent the bifurcation from happening [6], which in our case means to prevent the chronic disease. Similar to what we have just proposed here for humans is already done for security evaluation of power systems to prevent power outages (Pang et al., 1974) [7]. Measuring the parameters of a system of generators of electricity, the engineers can catch the moment when the system is close to losing stability. Using Lyapounov's functions  $V$ , they are finding the correction parameters that will make the system stable. By correcting these parameters, they are preventing oncoming destabilizations. This saves time, money, and prevents electric power outages.

#### V. CONCLUSION

In antiquity acupuncture was used for prevention rather than cure of chronic diseases. Now, when we know that the cure of chronic diseases is difficult and unpredictable, we should be looking for prevention rather than cure of chronic diseases. For this purpose, we will need new medical techniques allowing early detection of the subtle changes preceding chronic diseases.

In ancient times, doctors were able to detect with pulse diagnosis very subtle deviations from norm and catch 'disease' that would appear 5 to 7 years later. It is not yet 'disease' because clinical complaints are not yet present, but if not treated with time it would turn into disease. In modern times, even when preclinical

complaints are present, they are completely ignored. Such is the so-called 'moving pain', which moves from organ to organ.

Contemporary doctors presently classify the 'moving pain' as 'psychosomatic', which means the patients just imagine they have moving pain. It is always ignored because we do not have the necessary sensitive equipment to detect the subtle changes causing these symptoms. Neither can we explain them.

I think, the 'moving pain' reflects the movement of stress-induced phase shifts (delays) from organ to organ following the pathway of the organ's maximal activity described by 'the law of five elements' in acupuncture. When the phase shifts (delays) reach the genetically inherited weak organ, they accumulate there because the weak organ does not have enough energy to propel them. When the ultimate stress  $E_c$  is reached, which the weak organ can endure, the biorhythms of this weak organ will become desynchronized. This will lead to a dysfunction, or the genetically inherited weak organ will suffer functional (chronic) disease.

In the past (and presently) pulse diagnosis was successfully used in China, India, Vietnam, etc. for very early diagnosis of chronic diseases. Measuring the pulses (frequencies, amplitudes, etc.) of different organs on the surface of the body, and comparing the pulses on wrist, neck and ankles, these pulse diagnosticians can predict a disease 5 to 7 years before the symptoms would appear (or tell you about a disease you had 10 to 15 years ago). When the deviations from norm are caught early, one acupuncture treatment is usually enough to restore the health.

In England, Kanyon built apparatus called pulsograph [8], which can monitor the pulse changes just as a pulse diagnostician would do. The pulsograph registers amplitude and frequency changes in the rhythms of different organs. Just as pulse diagnosis, this pulsograph can detect very early subtle phase-shift changes in the biorhythms, which signal oncoming pathology long before preclinical complaints would appear.

We would like to believe that in the future such pulsograph would be connected to a computer with software that allows analysis of detected pulses. Using the last equation, the computer should be able to tell us the proper governing signal  $u$  that will restore the balance of the body or bring back its health. The computer should tell us how to modify the existing pulse parameters  $\theta_{ij}$ ,  $\omega_j$ ,  $T_{ij}$ ,  $\beta_i$ ,  $r_{ci}$ ,  $k_{pi}$  through acupuncture or other mild stressors, to achieve health balance. Therefore, computerized acupuncture will be the basis of the future acupuncture used to prevent chronic diseases. More details can be found in the book of Dr. Maria Kuman *Modern Aspects of Ancient Acupuncture* [9].

## REFERENCES RÉFÉRENCES REFERENCIAS

1. Prigogine I, Order out of Chaos, Bantam Books, Toronto-New York-London-Sydney, 1984.
2. Haken H, *Synergetics*, Springer-Verlag, Berlin-Heidelberg-New York, 1978.
3. Luce G G, *Biological Rhythms in Psychiatry and Medicine*, NIMH, Bethesda, Maryland, 1970.
4. Kuman(ova) M, Akupunktur und Stress, *Deutsche Zeitschrift fur Akupunktur*, 1985; 28, #5: 116-118.
5. Kuman (ova) M, *Acta Oto-, Rhyno-, Laryngologica Belgica*, 1984; 38: 523-529.
6. Nishikawa T, Ott E, *Chaos*, 2014; 24: 033107.
7. Pang C K, Prabcahara F S, El-Ablad A H, Koivo A J, *Trans. of Power Appl. and Syst.*, 1974; PAS-93, May-June.
8. Kanyon J N, *Modern Techniques of Acupuncture*, v.2., Thorson Publishing Group, England, 1983.
9. Kuman M, *Modern Aspects of Ancient Acupuncture*, Health and Happiness Books, 2008.



# GLOBAL JOURNALS GUIDELINES HANDBOOK 2019

---

[WWW.GLOBALJOURNALS.ORG](http://WWW.GLOBALJOURNALS.ORG)

# FELLOWS

## FELLOW OF ASSOCIATION OF RESEARCH SOCIETY IN MEDICAL (FARSM)

Global Journals Incorporate (USA) is accredited by Open Association of Research Society (OARS), U.S.A and in turn, awards “FARSM” title to individuals. The 'FARSM' title is accorded to a selected professional after the approval of the Editor-in-Chief/Editorial Board Members/Dean.



- The “FARSM” is a dignified title which is accorded to a person’s name viz. Dr. John E. Hall, Ph.D., FARSS or William Walldroff, M.S., FARSM.

FARSM accrediting is an honor. It authenticates your research activities. After recognition as FARSM, you can add 'FARSM' title with your name as you use this recognition as additional suffix to your status. This will definitely enhance and add more value and reputation to your name. You may use it on your professional Counseling Materials such as CV, Resume, and Visiting Card etc.

*The following benefits can be availed by you only for next three years from the date of certification:*



FARSM designated members are entitled to avail a 40% discount while publishing their research papers (of a single author) with Global Journals Incorporation (USA), if the same is accepted by Editorial Board/Peer Reviewers. If you are a main author or co-author in case of multiple authors, you will be entitled to avail discount of 10%.

Once FARSM title is accorded, the Fellow is authorized to organize a symposium/seminar/conference on behalf of Global Journal Incorporation (USA). The Fellow can also participate in conference/seminar/symposium organized by another institution as representative of Global Journal. In both the cases, it is mandatory for him to discuss with us and obtain our consent.



You may join as member of the Editorial Board of Global Journals Incorporation (USA) after successful completion of three years as Fellow and as Peer Reviewer. In addition, it is also desirable that you should organize seminar/symposium/conference at least once.

We shall provide you intimation regarding launching of e-version of journal of your stream time to time. This may be utilized in your library for the enrichment of knowledge of your students as well as it can also be helpful for the concerned faculty members.





The FARSM can go through standards of OARS. You can also play vital role if you have any suggestions so that proper amendment can take place to improve the same for the benefit of entire research community.

As FARSM, you will be given a renowned, secure and free professional email address with 100 GB of space e.g. [johnhall@globaljournals.org](mailto:johnhall@globaljournals.org). This will include Webmail, Spam Assassin, Email Forwarders, Auto-Responders, Email Delivery Route tracing, etc.

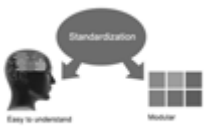

The FARSM will be eligible for a free application of standardization of their researches. Standardization of research will be subject to acceptability within stipulated norms as the next step after publishing in a journal. We shall depute a team of specialized research professionals who will render their services for elevating your researches to next higher level, which is worldwide open standardization.

The FARSM member can apply for grading and certification of standards of their educational and Institutional Degrees to Open Association of Research, Society U.S.A. Once you are designated as FARSM, you may send us a scanned copy of all of your credentials. OARS will verify, grade and certify them. This will be based on your academic records, quality of research papers published by you, and some more criteria. After certification of all your credentials by OARS, they will be published on your Fellow Profile link on website <https://associationofresearch.org> which will be helpful to upgrade the dignity.



The FARSM members can avail the benefits of free research podcasting in Global Research Radio with their research documents. After publishing the work, (including published elsewhere worldwide with proper authorization) you can upload your research paper with your recorded voice or you can utilize chargeable services of our professional RJs to record your paper in their voice on request.



The FARSM member also entitled to get the benefits of free research podcasting of their research documents through video clips. We can also streamline your conference videos and display your slides/ online slides and online research video clips at reasonable charges, on request.







The FARSM is eligible to earn from sales proceeds of his/her researches/reference/review Books or literature, while publishing with Global Journals. The FARSS can decide whether he/she would like to publish his/her research in a closed manner. In this case, whenever readers purchase that individual research paper for reading, maximum 60% of its profit earned as royalty by Global Journals, will be credited to his/her bank account. The entire entitled amount will be credited to his/her bank account exceeding limit of minimum fixed balance. There is no minimum time limit for collection. The FARSM member can decide its price and we can help in making the right decision.

The FARSM member is eligible to join as a paid peer reviewer at Global Journals Incorporation (USA) and can get remuneration of 15% of author fees, taken from the author of a respective paper. After reviewing 5 or more papers you can request to transfer the amount to your bank account.



## MEMBER OF ASSOCIATION OF RESEARCH SOCIETY IN MEDICAL (MARSM)

The ' MARSM ' title is accorded to a selected professional after the approval of the Editor-in-Chief / Editorial Board Members/Dean.

The “MARSM” is a dignified ornament which is accorded to a person’s name viz. Dr. John E. Hall, Ph.D., MARSM or William Walldroff, M.S., MARSM.



MARSM accrediting is an honor. It authenticates your research activities. After becoming MARSM, you can add 'MARSM' title with your name as you use this recognition as additional suffix to your status. This will definitely enhance and add more value and repute to your name. You may use it on your professional Counseling Materials such as CV, Resume, Visiting Card and Name Plate etc.

*The following benefits can be availed by you only for next three years from the date of certification.*



MARSM designated members are entitled to avail a 25% discount while publishing their research papers (of a single author) in Global Journals Inc., if the same is accepted by our Editorial Board and Peer Reviewers. If you are a main author or co-author of a group of authors, you will get discount of 10%.

As MARSM, you will be given a renowned, secure and free professional email address with 30 GB of space e.g. [johnhall@globaljournals.org](mailto:johnhall@globaljournals.org). This will include Webmail, Spam Assassin, Email Forwarders, Auto-Responders, Email Delivery Route tracing, etc.





We shall provide you intimation regarding launching of e-version of journal of your stream time to time. This may be utilized in your library for the enrichment of knowledge of your students as well as it can also be helpful for the concerned faculty members.

The MARSM member can apply for approval, grading and certification of standards of their educational and Institutional Degrees to Open Association of Research, Society U.S.A.



Once you are designated as MARSM, you may send us a scanned copy of all of your credentials. OARS will verify, grade and certify them. This will be based on your academic records, quality of research papers published by you, and some more criteria.

It is mandatory to read all terms and conditions carefully.



## AUXILIARY MEMBERSHIPS

### Institutional Fellow of Open Association of Research Society (USA) - OARS (USA)

Global Journals Incorporation (USA) is accredited by Open Association of Research Society, U.S.A (OARS) and in turn, affiliates research institutions as “Institutional Fellow of Open Association of Research Society” (IFOARS).



The “FARSC” is a dignified title which is accorded to a person’s name viz. Dr. John E. Hall, Ph.D., FARSC or William Walldroff, M.S., FARSC.

The IFOARS institution is entitled to form a Board comprised of one Chairperson and three to five board members preferably from different streams. The Board will be recognized as “Institutional Board of Open Association of Research Society”-(IBOARS).

*The Institute will be entitled to following benefits:*



The IBOARS can initially review research papers of their institute and recommend them to publish with respective journal of Global Journals. It can also review the papers of other institutions after obtaining our consent. The second review will be done by peer reviewer of Global Journals Incorporation (USA) The Board is at liberty to appoint a peer reviewer with the approval of chairperson after consulting us.

The author fees of such paper may be waived off up to 40%.

The Global Journals Incorporation (USA) at its discretion can also refer double blind peer reviewed paper at their end to the board for the verification and to get recommendation for final stage of acceptance of publication.



The IBOARS can organize symposium/seminar/conference in their country on behalf of Global Journals Incorporation (USA)-OARS (USA). The terms and conditions can be discussed separately.

The Board can also play vital role by exploring and giving valuable suggestions regarding the Standards of “Open Association of Research Society, U.S.A (OARS)” so that proper amendment can take place for the benefit of entire research community. We shall provide details of particular standard only on receipt of request from the Board.



The board members can also join us as Individual Fellow with 40% discount on total fees applicable to Individual Fellow. They will be entitled to avail all the benefits as declared. Please visit Individual Fellow-sub menu of GlobalJournals.org to have more relevant details.



We shall provide you intimation regarding launching of e-version of journal of your stream time to time. This may be utilized in your library for the enrichment of knowledge of your students as well as it can also be helpful for the concerned faculty members.

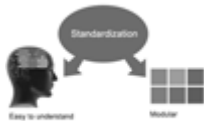

After nomination of your institution as “Institutional Fellow” and constantly functioning successfully for one year, we can consider giving recognition to your institute to function as Regional/Zonal office on our behalf. The board can also take up the additional allied activities for betterment after our consultation.

**The following entitlements are applicable to individual Fellows:**

Open Association of Research Society, U.S.A (OARS) By-laws states that an individual Fellow may use the designations as applicable, or the corresponding initials. The Credentials of individual Fellow and Associate designations signify that the individual has gained knowledge of the fundamental concepts. One is magnanimous and proficient in an expertise course covering the professional code of conduct, and follows recognized standards of practice.



Open Association of Research Society (US)/ Global Journals Incorporation (USA), as described in Corporate Statements, are educational, research publishing and professional membership organizations. Achieving our individual Fellow or Associate status is based mainly on meeting stated educational research requirements.

Disbursement of 40% Royalty earned through Global Journals : Researcher = 50%, Peer Reviewer = 37.50%, Institution = 12.50% E.g. Out of 40%, the 20% benefit should be passed on to researcher, 15 % benefit towards remuneration should be given to a reviewer and remaining 5% is to be retained by the institution.



We shall provide print version of 12 issues of any three journals [as per your requirement] out of our 38 journals worth \$ 2376 USD.

**Other:**

**The individual Fellow and Associate designations accredited by Open Association of Research Society (US) credentials signify guarantees following achievements:**

- The professional accredited with Fellow honor, is entitled to various benefits viz. name, fame, honor, regular flow of income, secured bright future, social status etc.



- In addition to above, if one is single author, then entitled to 40% discount on publishing research paper and can get 10% discount if one is co-author or main author among group of authors.
- The Fellow can organize symposium/seminar/conference on behalf of Global Journals Incorporation (USA) and he/she can also attend the same organized by other institutes on behalf of Global Journals.
- The Fellow can become member of Editorial Board Member after completing 3yrs.
- The Fellow can earn 60% of sales proceeds from the sale of reference/review books/literature/publishing of research paper.
- Fellow can also join as paid peer reviewer and earn 15% remuneration of author charges and can also get an opportunity to join as member of the Editorial Board of Global Journals Incorporation (USA)
- • This individual has learned the basic methods of applying those concepts and techniques to common challenging situations. This individual has further demonstrated an in-depth understanding of the application of suitable techniques to a particular area of research practice.

**Note :**

//

- In future, if the board feels the necessity to change any board member, the same can be done with the consent of the chairperson along with anyone board member without our approval.
- In case, the chairperson needs to be replaced then consent of 2/3rd board members are required and they are also required to jointly pass the resolution copy of which should be sent to us. In such case, it will be compulsory to obtain our approval before replacement.
- In case of “Difference of Opinion [if any]” among the Board members, our decision will be final and binding to everyone.

//





# PREFERRED AUTHOR GUIDELINES

## **We accept the manuscript submissions in any standard (generic) format.**

We typeset manuscripts using advanced typesetting tools like Adobe In Design, CorelDraw, TeXnicCenter, and TeXStudio. We usually recommend authors submit their research using any standard format they are comfortable with, and let Global Journals do the rest.

Alternatively, you can download our basic template from <https://globaljournals.org/Template>

Authors should submit their complete paper/article, including text illustrations, graphics, conclusions, artwork, and tables. Authors who are not able to submit manuscript using the form above can email the manuscript department at [submit@globaljournals.org](mailto:submit@globaljournals.org) or get in touch with [chiefeditor@globaljournals.org](mailto:chiefeditor@globaljournals.org) if they wish to send the abstract before submission.

## BEFORE AND DURING SUBMISSION

Authors must ensure the information provided during the submission of a paper is authentic. Please go through the following checklist before submitting:

1. Authors must go through the complete author guideline and understand and *agree to Global Journals' ethics and code of conduct*, along with author responsibilities.
2. Authors must accept the privacy policy, terms, and conditions of Global Journals.
3. Ensure corresponding author's email address and postal address are accurate and reachable.
4. Manuscript to be submitted must include keywords, an abstract, a paper title, co-author(s') names and details (email address, name, phone number, and institution), figures and illustrations in vector format including appropriate captions, tables, including titles and footnotes, a conclusion, results, acknowledgments and references.
5. Authors should submit paper in a ZIP archive if any supplementary files are required along with the paper.
6. Proper permissions must be acquired for the use of any copyrighted material.
7. Manuscript submitted *must not have been submitted or published elsewhere* and all authors must be aware of the submission.

## **Declaration of Conflicts of Interest**

It is required for authors to declare all financial, institutional, and personal relationships with other individuals and organizations that could influence (bias) their research.

## POLICY ON PLAGIARISM

Plagiarism is not acceptable in Global Journals submissions at all.

Plagiarized content will not be considered for publication. We reserve the right to inform authors' institutions about plagiarism detected either before or after publication. If plagiarism is identified, we will follow COPE guidelines:

Authors are solely responsible for all the plagiarism that is found. The author must not fabricate, falsify or plagiarize existing research data. The following, if copied, will be considered plagiarism:

- Words (language)
- Ideas
- Findings
- Writings
- Diagrams
- Graphs
- Illustrations
- Lectures



- Printed material
- Graphic representations
- Computer programs
- Electronic material
- Any other original work

## AUTHORSHIP POLICIES

Global Journals follows the definition of authorship set up by the Open Association of Research Society, USA. According to its guidelines, authorship criteria must be based on:

1. Substantial contributions to the conception and acquisition of data, analysis, and interpretation of findings.
2. Drafting the paper and revising it critically regarding important academic content.
3. Final approval of the version of the paper to be published.

### Changes in Authorship

The corresponding author should mention the name and complete details of all co-authors during submission and in manuscript. We support addition, rearrangement, manipulation, and deletions in authors list till the early view publication of the journal. We expect that corresponding author will notify all co-authors of submission. We follow COPE guidelines for changes in authorship.

### Copyright

During submission of the manuscript, the author is confirming an exclusive license agreement with Global Journals which gives Global Journals the authority to reproduce, reuse, and republish authors' research. We also believe in flexible copyright terms where copyright may remain with authors/employers/institutions as well. Contact your editor after acceptance to choose your copyright policy. You may follow this form for copyright transfers.

### Appealing Decisions

Unless specified in the notification, the Editorial Board's decision on publication of the paper is final and cannot be appealed before making the major change in the manuscript.

### Acknowledgments

Contributors to the research other than authors credited should be mentioned in Acknowledgments. The source of funding for the research can be included. Suppliers of resources may be mentioned along with their addresses.

### Declaration of funding sources

Global Journals is in partnership with various universities, laboratories, and other institutions worldwide in the research domain. Authors are requested to disclose their source of funding during every stage of their research, such as making analysis, performing laboratory operations, computing data, and using institutional resources, from writing an article to its submission. This will also help authors to get reimbursements by requesting an open access publication letter from Global Journals and submitting to the respective funding source.

## PREPARING YOUR MANUSCRIPT

Authors can submit papers and articles in an acceptable file format: MS Word (doc, docx), LaTeX (.tex, .zip or .rar including all of your files), Adobe PDF (.pdf), rich text format (.rtf), simple text document (.txt), Open Document Text (.odt), and Apple Pages (.pages). Our professional layout editors will format the entire paper according to our official guidelines. This is one of the highlights of publishing with Global Journals—authors should not be concerned about the formatting of their paper. Global Journals accepts articles and manuscripts in every major language, be it Spanish, Chinese, Japanese, Portuguese, Russian, French, German, Dutch, Italian, Greek, or any other national language, but the title, subtitle, and abstract should be in English. This will facilitate indexing and the pre-peer review process.

The following is the official style and template developed for publication of a research paper. Authors are not required to follow this style during the submission of the paper. It is just for reference purposes.



### ***Manuscript Style Instruction (Optional)***

- Microsoft Word Document Setting Instructions.
- Font type of all text should be Swis721 Lt BT.
- Page size: 8.27" x 11", left margin: 0.65, right margin: 0.65, bottom margin: 0.75.
- Paper title should be in one column of font size 24.
- Author name in font size of 11 in one column.
- Abstract: font size 9 with the word "Abstract" in bold italics.
- Main text: font size 10 with two justified columns.
- Two columns with equal column width of 3.38 and spacing of 0.2.
- First character must be three lines drop-capped.
- The paragraph before spacing of 1 pt and after of 0 pt.
- Line spacing of 1 pt.
- Large images must be in one column.
- The names of first main headings (Heading 1) must be in Roman font, capital letters, and font size of 10.
- The names of second main headings (Heading 2) must not include numbers and must be in italics with a font size of 10.

### ***Structure and Format of Manuscript***

The recommended size of an original research paper is under 15,000 words and review papers under 7,000 words. Research articles should be less than 10,000 words. Research papers are usually longer than review papers. Review papers are reports of significant research (typically less than 7,000 words, including tables, figures, and references)

A research paper must include:

- a) A title which should be relevant to the theme of the paper.
- b) A summary, known as an abstract (less than 150 words), containing the major results and conclusions.
- c) Up to 10 keywords that precisely identify the paper's subject, purpose, and focus.
- d) An introduction, giving fundamental background objectives.
- e) Resources and techniques with sufficient complete experimental details (wherever possible by reference) to permit repetition, sources of information must be given, and numerical methods must be specified by reference.
- f) Results which should be presented concisely by well-designed tables and figures.
- g) Suitable statistical data should also be given.
- h) All data must have been gathered with attention to numerical detail in the planning stage.

Design has been recognized to be essential to experiments for a considerable time, and the editor has decided that any paper that appears not to have adequate numerical treatments of the data will be returned unrefereed.

- i) Discussion should cover implications and consequences and not just recapitulate the results; conclusions should also be summarized.
- j) There should be brief acknowledgments.
- k) There ought to be references in the conventional format. Global Journals recommends APA format.

Authors should carefully consider the preparation of papers to ensure that they communicate effectively. Papers are much more likely to be accepted if they are carefully designed and laid out, contain few or no errors, are summarizing, and follow instructions. They will also be published with much fewer delays than those that require much technical and editorial correction.

The Editorial Board reserves the right to make literary corrections and suggestions to improve brevity.

## FORMAT STRUCTURE

***It is necessary that authors take care in submitting a manuscript that is written in simple language and adheres to published guidelines.***

All manuscripts submitted to Global Journals should include:

### **Title**

The title page must carry an informative title that reflects the content, a running title (less than 45 characters together with spaces), names of the authors and co-authors, and the place(s) where the work was carried out.

### **Author details**

The full postal address of any related author(s) must be specified.

### **Abstract**

The abstract is the foundation of the research paper. It should be clear and concise and must contain the objective of the paper and inferences drawn. It is advised to not include big mathematical equations or complicated jargon.

Many researchers searching for information online will use search engines such as Google, Yahoo or others. By optimizing your paper for search engines, you will amplify the chance of someone finding it. In turn, this will make it more likely to be viewed and cited in further works. Global Journals has compiled these guidelines to facilitate you to maximize the web-friendliness of the most public part of your paper.

### **Keywords**

A major lynchpin of research work for the writing of research papers is the keyword search, which one will employ to find both library and internet resources. Up to eleven keywords or very brief phrases have to be given to help data retrieval, mining, and indexing.

One must be persistent and creative in using keywords. An effective keyword search requires a strategy: planning of a list of possible keywords and phrases to try.

Choice of the main keywords is the first tool of writing a research paper. Research paper writing is an art. Keyword search should be as strategic as possible.

One should start brainstorming lists of potential keywords before even beginning searching. Think about the most important concepts related to research work. Ask, "What words would a source have to include to be truly valuable in a research paper?" Then consider synonyms for the important words.

It may take the discovery of only one important paper to steer in the right keyword direction because, in most databases, the keywords under which a research paper is abstracted are listed with the paper.

### **Numerical Methods**

Numerical methods used should be transparent and, where appropriate, supported by references.

### **Abbreviations**

Authors must list all the abbreviations used in the paper at the end of the paper or in a separate table before using them.

### **Formulas and equations**

Authors are advised to submit any mathematical equation using either MathJax, KaTeX, or LaTeX, or in a very high-quality image.

### **Tables, Figures, and Figure Legends**

Tables: Tables should be cautiously designed, uncrowned, and include only essential data. Each must have an Arabic number, e.g., Table 4, a self-explanatory caption, and be on a separate sheet. Authors must submit tables in an editable format and not as images. References to these tables (if any) must be mentioned accurately.



## Figures

Figures are supposed to be submitted as separate files. Always include a citation in the text for each figure using Arabic numbers, e.g., Fig. 4. Artwork must be submitted online in vector electronic form or by emailing it.

### PREPARATION OF ELETRONIC FIGURES FOR PUBLICATION

Although low-quality images are sufficient for review purposes, print publication requires high-quality images to prevent the final product being blurred or fuzzy. Submit (possibly by e-mail) EPS (line art) or TIFF (halftone/ photographs) files only. MS PowerPoint and Word Graphics are unsuitable for printed pictures. Avoid using pixel-oriented software. Scans (TIFF only) should have a resolution of at least 350 dpi (halftone) or 700 to 1100 dpi (line drawings). Please give the data for figures in black and white or submit a Color Work Agreement form. EPS files must be saved with fonts embedded (and with a TIFF preview, if possible).

For scanned images, the scanning resolution at final image size ought to be as follows to ensure good reproduction: line art: >650 dpi; halftones (including gel photographs): >350 dpi; figures containing both halftone and line images: >650 dpi.

Color charges: Authors are advised to pay the full cost for the reproduction of their color artwork. Hence, please note that if there is color artwork in your manuscript when it is accepted for publication, we would require you to complete and return a Color Work Agreement form before your paper can be published. Also, you can email your editor to remove the color fee after acceptance of the paper.

### TIPS FOR WRITING A GOOD QUALITY MEDICAL RESEARCH PAPER

**1. Choosing the topic:** In most cases, the topic is selected by the interests of the author, but it can also be suggested by the guides. You can have several topics, and then judge which you are most comfortable with. This may be done by asking several questions of yourself, like "Will I be able to carry out a search in this area? Will I find all necessary resources to accomplish the search? Will I be able to find all information in this field area?" If the answer to this type of question is "yes," then you ought to choose that topic. In most cases, you may have to conduct surveys and visit several places. Also, you might have to do a lot of work to find all the rises and falls of the various data on that subject. Sometimes, detailed information plays a vital role, instead of short information. Evaluators are human: The first thing to remember is that evaluators are also human beings. They are not only meant for rejecting a paper. They are here to evaluate your paper. So present your best aspect.

**2. Think like evaluators:** If you are in confusion or getting demotivated because your paper may not be accepted by the evaluators, then think, and try to evaluate your paper like an evaluator. Try to understand what an evaluator wants in your research paper, and you will automatically have your answer. Make blueprints of paper: The outline is the plan or framework that will help you to arrange your thoughts. It will make your paper logical. But remember that all points of your outline must be related to the topic you have chosen.

**3. Ask your guides:** If you are having any difficulty with your research, then do not hesitate to share your difficulty with your guide (if you have one). They will surely help you out and resolve your doubts. If you can't clarify what exactly you require for your work, then ask your supervisor to help you with an alternative. He or she might also provide you with a list of essential readings.

**4. Use of computer is recommended:** As you are doing research in the field of medical research then this point is quite obvious. Use right software: Always use good quality software packages. If you are not capable of judging good software, then you can lose the quality of your paper unknowingly. There are various programs available to help you which you can get through the internet.

**5. Use the internet for help:** An excellent start for your paper is using Google. It is a wondrous search engine, where you can have your doubts resolved. You may also read some answers for the frequent question of how to write your research paper or find a model research paper. You can download books from the internet. If you have all the required books, place importance on reading, selecting, and analyzing the specified information. Then sketch out your research paper. Use big pictures: You may use encyclopedias like Wikipedia to get pictures with the best resolution. At Global Journals, you should strictly follow here.





**6. Bookmarks are useful:** When you read any book or magazine, you generally use bookmarks, right? It is a good habit which helps to not lose your continuity. You should always use bookmarks while searching on the internet also, which will make your search easier.

**7. Revise what you wrote:** When you write anything, always read it, summarize it, and then finalize it.

**8. Make every effort:** Make every effort to mention what you are going to write in your paper. That means always have a good start. Try to mention everything in the introduction—what is the need for a particular research paper. Polish your work with good writing skills and always give an evaluator what he wants. Make backups: When you are going to do any important thing like making a research paper, you should always have backup copies of it either on your computer or on paper. This protects you from losing any portion of your important data.

**9. Produce good diagrams of your own:** Always try to include good charts or diagrams in your paper to improve quality. Using several unnecessary diagrams will degrade the quality of your paper by creating a hodgepodge. So always try to include diagrams which were made by you to improve the readability of your paper. Use of direct quotes: When you do research relevant to literature, history, or current affairs, then use of quotes becomes essential, but if the study is relevant to science, use of quotes is not preferable.

**10. Use proper verb tense:** Use proper verb tenses in your paper. Use past tense to present those events that have happened. Use present tense to indicate events that are going on. Use future tense to indicate events that will happen in the future. Use of wrong tenses will confuse the evaluator. Avoid sentences that are incomplete.

**11. Pick a good study spot:** Always try to pick a spot for your research which is quiet. Not every spot is good for studying.

**12. Know what you know:** Always try to know what you know by making objectives, otherwise you will be confused and unable to achieve your target.

**13. Use good grammar:** Always use good grammar and words that will have a positive impact on the evaluator; use of good vocabulary does not mean using tough words which the evaluator has to find in a dictionary. Do not fragment sentences. Eliminate one-word sentences. Do not ever use a big word when a smaller one would suffice.

Verbs have to be in agreement with their subjects. In a research paper, do not start sentences with conjunctions or finish them with prepositions. When writing formally, it is advisable to never split an infinitive because someone will (wrongly) complain. Avoid clichés like a disease. Always shun irritating alliteration. Use language which is simple and straightforward. Put together a neat summary.

**14. Arrangement of information:** Each section of the main body should start with an opening sentence, and there should be a changeover at the end of the section. Give only valid and powerful arguments for your topic. You may also maintain your arguments with records.

**15. Never start at the last minute:** Always allow enough time for research work. Leaving everything to the last minute will degrade your paper and spoil your work.

**16. Multitasking in research is not good:** Doing several things at the same time is a bad habit in the case of research activity. Research is an area where everything has a particular time slot. Divide your research work into parts, and do a particular part in a particular time slot.

**17. Never copy others' work:** Never copy others' work and give it your name because if the evaluator has seen it anywhere, you will be in trouble. Take proper rest and food: No matter how many hours you spend on your research activity, if you are not taking care of your health, then all your efforts will have been in vain. For quality research, take proper rest and food.

**18. Go to seminars:** Attend seminars if the topic is relevant to your research area. Utilize all your resources.

**19. Refresh your mind after intervals:** Try to give your mind a rest by listening to soft music or sleeping in intervals. This will also improve your memory. Acquire colleagues: Always try to acquire colleagues. No matter how sharp you are, if you acquire colleagues, they can give you ideas which will be helpful to your research.



**20. Think technically:** Always think technically. If anything happens, search for its reasons, benefits, and demerits. Think and then print: When you go to print your paper, check that tables are not split, headings are not detached from their descriptions, and page sequence is maintained.

**21. Adding unnecessary information:** Do not add unnecessary information like "I have used MS Excel to draw graphs." Irrelevant and inappropriate material is superfluous. Foreign terminology and phrases are not apropos. One should never take a broad view. Analogy is like feathers on a snake. Use words properly, regardless of how others use them. Remove quotations. Puns are for kids, not grunt readers. Never oversimplify: When adding material to your research paper, never go for oversimplification; this will definitely irritate the evaluator. Be specific. Never use rhythmic redundancies. Contractions shouldn't be used in a research paper. Comparisons are as terrible as clichés. Give up ampersands, abbreviations, and so on. Remove commas that are not necessary. Parenthetical words should be between brackets or commas. Understatement is always the best way to put forward earth-shaking thoughts. Give a detailed literary review.

**22. Report concluded results:** Use concluded results. From raw data, filter the results, and then conclude your studies based on measurements and observations taken. An appropriate number of decimal places should be used. Parenthetical remarks are prohibited here. Proofread carefully at the final stage. At the end, give an outline to your arguments. Spot perspectives of further study of the subject. Justify your conclusion at the bottom sufficiently, which will probably include examples.

**23. Upon conclusion:** Once you have concluded your research, the next most important step is to present your findings. Presentation is extremely important as it is the definite medium through which your research is going to be in print for the rest of the crowd. Care should be taken to categorize your thoughts well and present them in a logical and neat manner. A good quality research paper format is essential because it serves to highlight your research paper and bring to light all necessary aspects of your research.

## INFORMAL GUIDELINES OF RESEARCH PAPER WRITING

### **Key points to remember:**

- Submit all work in its final form.
- Write your paper in the form which is presented in the guidelines using the template.
- Please note the criteria peer reviewers will use for grading the final paper.

### **Final points:**

One purpose of organizing a research paper is to let people interpret your efforts selectively. The journal requires the following sections, submitted in the order listed, with each section starting on a new page:

*The introduction:* This will be compiled from reference matter and reflect the design processes or outline of basis that directed you to make a study. As you carry out the process of study, the method and process section will be constructed like that. The results segment will show related statistics in nearly sequential order and direct reviewers to similar intellectual paths throughout the data that you gathered to carry out your study.

### **The discussion section:**

This will provide understanding of the data and projections as to the implications of the results. The use of good quality references throughout the paper will give the effort trustworthiness by representing an alertness to prior workings.

Writing a research paper is not an easy job, no matter how trouble-free the actual research or concept. Practice, excellent preparation, and controlled record-keeping are the only means to make straightforward progression.

### **General style:**

Specific editorial column necessities for compliance of a manuscript will always take over from directions in these general guidelines.

**To make a paper clear:** Adhere to recommended page limits.



### *Mistakes to avoid:*

- Insertion of a title at the foot of a page with subsequent text on the next page.
- Separating a table, chart, or figure—confine each to a single page.
- Submitting a manuscript with pages out of sequence.
- In every section of your document, use standard writing style, including articles ("a" and "the").
- Keep paying attention to the topic of the paper.
- Use paragraphs to split each significant point (excluding the abstract).
- Align the primary line of each section.
- Present your points in sound order.
- Use present tense to report well-accepted matters.
- Use past tense to describe specific results.
- Do not use familiar wording; don't address the reviewer directly. Don't use slang or superlatives.
- Avoid use of extra pictures—include only those figures essential to presenting results.

### **Title page:**

Choose a revealing title. It should be short and include the name(s) and address(es) of all authors. It should not have acronyms or abbreviations or exceed two printed lines.

**Abstract:** This summary should be two hundred words or less. It should clearly and briefly explain the key findings reported in the manuscript and must have precise statistics. It should not have acronyms or abbreviations. It should be logical in itself. Do not cite references at this point.

An abstract is a brief, distinct paragraph summary of finished work or work in development. In a minute or less, a reviewer can be taught the foundation behind the study, common approaches to the problem, relevant results, and significant conclusions or new questions.

Write your summary when your paper is completed because how can you write the summary of anything which is not yet written? Wealth of terminology is very essential in abstract. Use comprehensive sentences, and do not sacrifice readability for brevity; you can maintain it succinctly by phrasing sentences so that they provide more than a lone rationale. The author can at this moment go straight to shortening the outcome. Sum up the study with the subsequent elements in any summary. Try to limit the initial two items to no more than one line each.

*Reason for writing the article—theory, overall issue, purpose.*

- Fundamental goal.
- To-the-point depiction of the research.
- Consequences, including definite statistics—if the consequences are quantitative in nature, account for this; results of any numerical analysis should be reported. Significant conclusions or questions that emerge from the research.

### **Approach:**

- Single section and succinct.
- An outline of the job done is always written in past tense.
- Concentrate on shortening results—limit background information to a verdict or two.
- Exact spelling, clarity of sentences and phrases, and appropriate reporting of quantities (proper units, important statistics) are just as significant in an abstract as they are anywhere else.

### **Introduction:**

The introduction should "introduce" the manuscript. The reviewer should be presented with sufficient background information to be capable of comprehending and calculating the purpose of your study without having to refer to other works. The basis for the study should be offered. Give the most important references, but avoid making a comprehensive appraisal of the topic. Describe the problem visibly. If the problem is not acknowledged in a logical, reasonable way, the reviewer will give no attention to your results. Speak in common terms about techniques used to explain the problem, if needed, but do not present any particulars about the protocols here.



*The following approach can create a valuable beginning:*

- Explain the value (significance) of the study.
- Defend the model—why did you employ this particular system or method? What is its compensation? Remark upon its appropriateness from an abstract point of view as well as pointing out sensible reasons for using it.
- Present a justification. State your particular theory(-ies) or aim(s), and describe the logic that led you to choose them.
- Briefly explain the study's tentative purpose and how it meets the declared objectives.

#### **Approach:**

Use past tense except for when referring to recognized facts. After all, the manuscript will be submitted after the entire job is done. Sort out your thoughts; manufacture one key point for every section. If you make the four points listed above, you will need at least four paragraphs. Present surrounding information only when it is necessary to support a situation. The reviewer does not desire to read everything you know about a topic. Shape the theory specifically—do not take a broad view.

As always, give awareness to spelling, simplicity, and correctness of sentences and phrases.

#### **Procedures (methods and materials):**

This part is supposed to be the easiest to carve if you have good skills. A soundly written procedures segment allows a capable scientist to replicate your results. Present precise information about your supplies. The suppliers and clarity of reagents can be helpful bits of information. Present methods in sequential order, but linked methodologies can be grouped as a segment. Be concise when relating the protocols. Attempt to give the least amount of information that would permit another capable scientist to replicate your outcome, but be cautious that vital information is integrated. The use of subheadings is suggested and ought to be synchronized with the results section.

When a technique is used that has been well-described in another section, mention the specific item describing the way, but draw the basic principle while stating the situation. The purpose is to show all particular resources and broad procedures so that another person may use some or all of the methods in one more study or referee the scientific value of your work. It is not to be a step-by-step report of the whole thing you did, nor is a methods section a set of orders.

#### **Materials:**

*Materials may be reported in part of a section or else they may be recognized along with your measures.*

#### **Methods:**

- Report the method and not the particulars of each process that engaged the same methodology.
- Describe the method entirely.
- To be succinct, present methods under headings dedicated to specific dealings or groups of measures.
- Simplify—detail how procedures were completed, not how they were performed on a particular day.
- If well-known procedures were used, account for the procedure by name, possibly with a reference, and that's all.

#### **Approach:**

It is embarrassing to use vigorous voice when documenting methods without using first person, which would focus the reviewer's interest on the researcher rather than the job. As a result, when writing up the methods, most authors use third person passive voice.

Use standard style in this and every other part of the paper—avoid familiar lists, and use full sentences.

#### **What to keep away from:**

- Resources and methods are not a set of information.
- Skip all descriptive information and surroundings—save it for the argument.
- Leave out information that is immaterial to a third party.



**Results:**

The principle of a results segment is to present and demonstrate your conclusion. Create this part as entirely objective details of the outcome, and save all understanding for the discussion.

The page length of this segment is set by the sum and types of data to be reported. Use statistics and tables, if suitable, to present consequences most efficiently.

You must clearly differentiate material which would usually be incorporated in a study editorial from any unprocessed data or additional appendix matter that would not be available. In fact, such matters should not be submitted at all except if requested by the instructor.

**Content:**

- Sum up your conclusions in text and demonstrate them, if suitable, with figures and tables.
- In the manuscript, explain each of your consequences, and point the reader to remarks that are most appropriate.
- Present a background, such as by describing the question that was addressed by creation of an exacting study.
- Explain results of control experiments and give remarks that are not accessible in a prescribed figure or table, if appropriate.
- Examine your data, then prepare the analyzed (transformed) data in the form of a figure (graph), table, or manuscript.

**What to stay away from:**

- Do not discuss or infer your outcome, report surrounding information, or try to explain anything.
- Do not include raw data or intermediate calculations in a research manuscript.
- Do not present similar data more than once.
- A manuscript should complement any figures or tables, not duplicate information.
- Never confuse figures with tables—there is a difference.

**Approach:**

As always, use past tense when you submit your results, and put the whole thing in a reasonable order.

Put figures and tables, appropriately numbered, in order at the end of the report.

If you desire, you may place your figures and tables properly within the text of your results section.

**Figures and tables:**

If you put figures and tables at the end of some details, make certain that they are visibly distinguished from any attached appendix materials, such as raw facts. Whatever the position, each table must be titled, numbered one after the other, and include a heading. All figures and tables must be divided from the text.

**Discussion:**

The discussion is expected to be the trickiest segment to write. A lot of papers submitted to the journal are discarded based on problems with the discussion. There is no rule for how long an argument should be.

Position your understanding of the outcome visibly to lead the reviewer through your conclusions, and then finish the paper with a summing up of the implications of the study. The purpose here is to offer an understanding of your results and support all of your conclusions, using facts from your research and generally accepted information, if suitable. The implication of results should be fully described.

Infer your data in the conversation in suitable depth. This means that when you clarify an observable fact, you must explain mechanisms that may account for the observation. If your results vary from your prospect, make clear why that may have happened. If your results agree, then explain the theory that the proof supported. It is never suitable to just state that the data approved the prospect, and let it drop at that. Make a decision as to whether each premise is supported or discarded or if you cannot make a conclusion with assurance. Do not just dismiss a study or part of a study as "uncertain."





Research papers are not acknowledged if the work is imperfect. Draw what conclusions you can based upon the results that you have, and take care of the study as a finished work.

- You may propose future guidelines, such as how an experiment might be personalized to accomplish a new idea.
- Give details of all of your remarks as much as possible, focusing on mechanisms.
- Make a decision as to whether the tentative design sufficiently addressed the theory and whether or not it was correctly restricted. Try to present substitute explanations if they are sensible alternatives.
- One piece of research will not counter an overall question, so maintain the large picture in mind. Where do you go next? The best studies unlock new avenues of study. What questions remain?
- Recommendations for detailed papers will offer supplementary suggestions.

**Approach:**

When you refer to information, differentiate data generated by your own studies from other available information. Present work done by specific persons (including you) in past tense.

Describe generally acknowledged facts and main beliefs in present tense.

## THE ADMINISTRATION RULES

Administration Rules to Be Strictly Followed before Submitting Your Research Paper to Global Journals Inc.

*Please read the following rules and regulations carefully before submitting your research paper to Global Journals Inc. to avoid rejection.*

*Segment draft and final research paper:* You have to strictly follow the template of a research paper, failing which your paper may get rejected. You are expected to write each part of the paper wholly on your own. The peer reviewers need to identify your own perspective of the concepts in your own terms. Please do not extract straight from any other source, and do not rephrase someone else's analysis. Do not allow anyone else to proofread your manuscript.

*Written material:* You may discuss this with your guides and key sources. Do not copy anyone else's paper, even if this is only imitation, otherwise it will be rejected on the grounds of plagiarism, which is illegal. Various methods to avoid plagiarism are strictly applied by us to every paper, and, if found guilty, you may be blacklisted, which could affect your career adversely. To guard yourself and others from possible illegal use, please do not permit anyone to use or even read your paper and file.



CRITERION FOR GRADING A RESEARCH PAPER (COMPILATION)  
BY GLOBAL JOURNALS

Please note that following table is only a Grading of "Paper Compilation" and not on "Performed/Stated Research" whose grading solely depends on Individual Assigned Peer Reviewer and Editorial Board Member. These can be available only on request and after decision of Paper. This report will be the property of Global Journals.

Topics	Grades		
	A-B	C-D	E-F
<i>Abstract</i>	Clear and concise with appropriate content, Correct format. 200 words or below	Unclear summary and no specific data, Incorrect form Above 200 words	No specific data with ambiguous information Above 250 words
<i>Introduction</i>	Containing all background details with clear goal and appropriate details, flow specification, no grammar and spelling mistake, well organized sentence and paragraph, reference cited	Unclear and confusing data, appropriate format, grammar and spelling errors with unorganized matter	Out of place depth and content, hazy format
<i>Methods and Procedures</i>	Clear and to the point with well arranged paragraph, precision and accuracy of facts and figures, well organized subheads	Difficult to comprehend with embarrassed text, too much explanation but completed	Incorrect and unorganized structure with hazy meaning
<i>Result</i>	Well organized, Clear and specific, Correct units with precision, correct data, well structuring of paragraph, no grammar and spelling mistake	Complete and embarrassed text, difficult to comprehend	Irregular format with wrong facts and figures
<i>Discussion</i>	Well organized, meaningful specification, sound conclusion, logical and concise explanation, highly structured paragraph reference cited	Wordy, unclear conclusion, spurious	Conclusion is not cited, unorganized, difficult to comprehend
<i>References</i>	Complete and correct format, well organized	Beside the point, Incomplete	Wrong format and structuring



# INDEX

---

---

## **A**

Acetylcholine · 30  
Adrenaline · 18  
Atherosclerosis · 50

---

## **C**

Calorimetry · 52, 54, 56  
Chronological · 43

---

## **D**

Dehydrogenase · 53  
Desipramine · 30  
Dysregulation · 49

---

## **E**

Endocrine · 14, 16, 20  
Epilepsy · 1, 2, 3, 5, 9  
Epileptogenic · 2  
Equatorial · 24

---

## **G**

Germination · 19

---

## **M**

Maladaptation · 49  
Malignancy · 20, 37, 40  
Meridians · 12, 32  
Metaphysics · 12

---

## **N**

Neurotoxic · 30

---

## **P**

Parasympathetic · 35, 37, 40  
Paroxysmal · 1  
Plexus · 18  
Psychosomatic · 47  
Pulsograph · 47

---

## **R**

Retrospection · 12

---

## **S**

Sympathetic · 35, 37, 40  
Synchronization, · 47



save our planet



# Global Journal of Medical Research

---

Visit us on the Web at [www.GlobalJournals.org](http://www.GlobalJournals.org) | [www.MedicalResearchJournal.org](http://www.MedicalResearchJournal.org)  
or email us at [helpdesk@globaljournals.org](mailto:helpdesk@globaljournals.org)

ISSN 9755896



© Global Journals