

# GLOBAL JOURNAL

OF RESEARCHES IN ENGINEERING: F

## Electrical and Electronic Engineering

Design of Robust Sensor

Monitor Carbon Monoxide

Highlights

Motor Speed Control

Microstrip Patch Antenna

Discovering Thoughts, Inventing Future

VOLUME 13

ISSUE 17

VERSION 1.0



GLOBAL JOURNAL OF RESEARCHES IN ENGINEERING:F  
ELECTRICAL AND ELECTRONICS ENGINEERING

---



GLOBAL JOURNAL OF RESEARCHES IN ENGINEERING: F  
ELECTRICAL AND ELECTRONICS ENGINEERING

VOLUME 13 ISSUE 17 (VER. 1.0)

---

OPEN ASSOCIATION OF RESEARCH SOCIETY

© Global Journal of  
Researches in Engineering.  
2013.

All rights reserved.

This is a special issue published in version 1.0  
of "Global Journal of Researches in  
Engineering." By Global Journals Inc.

All articles are open access articles distributed  
under "Global Journal of Researches in  
Engineering"

Reading License, which permits restricted use.  
Entire contents are copyright by of "Global  
Journal of Researches in Engineering" unless  
otherwise noted on specific articles.

No part of this publication may be reproduced  
or transmitted in any form or by any means,  
electronic or mechanical, including  
photocopy, recording, or any information  
storage and retrieval system, without written  
permission.

The opinions and statements made in this  
book are those of the authors concerned.  
Ultrapublishing has not verified and neither  
confirms nor denies any of the foregoing and  
no warranty or fitness is implied.

Engage with the contents herein at your own  
risk.

The use of this journal, and the terms and  
conditions for our providing information, is  
governed by our Disclaimer, Terms and  
Conditions and Privacy Policy given on our  
website [http://globaljournals.us/terms-and-condition/  
menu-id-1463/](http://globaljournals.us/terms-and-condition/menu-id-1463/).

By referring / using / reading / any type of  
association / referencing this journal, this  
signifies and you acknowledge that you have  
read them and that you accept and will be  
bound by the terms thereof.

All information, journals, this journal,  
activities undertaken, materials, services and  
our website, terms and conditions, privacy  
policy, and this journal is subject to change  
anytime without any prior notice.

Incorporation No.: 0423089  
License No.: 42125/022010/1186  
Registration No.: 430374  
Import-Export Code: 1109007027  
Employer Identification Number (EIN):  
USA Tax ID: 98-0673427

## Global Journals Inc.

(A Delaware USA Incorporation with "Good Standing"; Reg. Number: 0423089)

Sponsors: Open Association of Research Society  
Open Scientific Standards

### *Publisher's Headquarters office*

Global Journals Headquarters  
301st Edgewater Place Suite, 100 Edgewater Dr.-Pl,  
Wakefield MASSACHUSETTS, Pin: 01880,  
United States of America

USA Toll Free: +001-888-839-7392

USA Toll Free Fax: +001-888-839-7392

### *Offset Typesetting*

Global Journals Incorporated  
2nd, Lansdowne, Lansdowne Rd., Croydon-Surrey,  
Pin: CR9 2ER, United Kingdom

### *Packaging & Continental Dispatching*

Global Journals  
E-3130 Sudama Nagar, Near Gopur Square,  
Indore, M.P., Pin:452009, India

### *Find a correspondence nodal officer near you*

To find nodal officer of your country, please  
email us at [local@globaljournals.org](mailto:local@globaljournals.org)

### *eContacts*

Press Inquiries: [press@globaljournals.org](mailto:press@globaljournals.org)  
Investor Inquiries: [investers@globaljournals.org](mailto:investers@globaljournals.org)  
Technical Support: [technology@globaljournals.org](mailto:technology@globaljournals.org)  
Media & Releases: [media@globaljournals.org](mailto:media@globaljournals.org)

### *Pricing (Including by Air Parcel Charges):*

*For Authors:*

22 USD (B/W) & 50 USD (Color)

*Yearly Subscription (Personal & Institutional):*

200 USD (B/W) & 250 USD (Color)

INTEGRATED EDITORIAL BOARD  
(COMPUTER SCIENCE, ENGINEERING, MEDICAL, MANAGEMENT, NATURAL  
SCIENCE, SOCIAL SCIENCE)

**John A. Hamilton, "Drew" Jr.,**  
Ph.D., Professor, Management  
Computer Science and Software  
Engineering  
Director, Information Assurance  
Laboratory  
Auburn University

**Dr. Henry Hexmoor**  
IEEE senior member since 2004  
Ph.D. Computer Science, University at  
Buffalo  
Department of Computer Science  
Southern Illinois University at Carbondale

**Dr. Osman Balci, Professor**  
Department of Computer Science  
Virginia Tech, Virginia University  
Ph.D. and M.S. Syracuse University,  
Syracuse, New York  
M.S. and B.S. Bogazici University,  
Istanbul, Turkey

**Yogita Bajpai**  
M.Sc. (Computer Science), FICCT  
U.S.A. Email:  
yogita@computerresearch.org

**Dr. T. David A. Forbes**  
Associate Professor and Range  
Nutritionist  
Ph.D. Edinburgh University - Animal  
Nutrition  
M.S. Aberdeen University - Animal  
Nutrition  
B.A. University of Dublin- Zoology

**Dr. Wenying Feng**  
Professor, Department of Computing &  
Information Systems  
Department of Mathematics  
Trent University, Peterborough,  
ON Canada K9J 7B8

**Dr. Thomas Wischgoll**  
Computer Science and Engineering,  
Wright State University, Dayton, Ohio  
B.S., M.S., Ph.D.  
(University of Kaiserslautern)

**Dr. Abdurrahman Arslanyilmaz**  
Computer Science & Information Systems  
Department  
Youngstown State University  
Ph.D., Texas A&M University  
University of Missouri, Columbia  
Gazi University, Turkey

**Dr. Xiaohong He**  
Professor of International Business  
University of Quinnipiac  
BS, Jilin Institute of Technology; MA, MS,  
PhD., (University of Texas-Dallas)

**Burcin Becerik-Gerber**  
University of Southern California  
Ph.D. in Civil Engineering  
DDes from Harvard University  
M.S. from University of California, Berkeley  
& Istanbul University

**Dr. Bart Lambrecht**

Director of Research in Accounting and Finance  
Professor of Finance  
Lancaster University Management School  
BA (Antwerp); MPhil, MA, PhD  
(Cambridge)

**Dr. Carlos García Pont**

Associate Professor of Marketing  
IESE Business School, University of Navarra  
Doctor of Philosophy (Management),  
Massachusetts Institute of Technology  
(MIT)  
Master in Business Administration, IESE,  
University of Navarra  
Degree in Industrial Engineering,  
Universitat Politècnica de Catalunya

**Dr. Fotini Labropulu**

Mathematics - Luther College  
University of Regina  
Ph.D., M.Sc. in Mathematics  
B.A. (Honors) in Mathematics  
University of Windsor

**Dr. Lynn Lim**

Reader in Business and Marketing  
Roehampton University, London  
BCom, PGDip, MBA (Distinction), PhD,  
FHEA

**Dr. Mihaly Mezei**

ASSOCIATE PROFESSOR  
Department of Structural and Chemical  
Biology, Mount Sinai School of Medical  
Center  
Ph.D., Etsv Lornd University  
Postdoctoral Training,  
New York University

**Dr. Söhnke M. Bartram**

Department of Accounting and Finance  
Lancaster University Management School  
Ph.D. (WHU Koblenz)  
MBA/BBA (University of Saarbrücken)

**Dr. Miguel Angel Ariño**

Professor of Decision Sciences  
IESE Business School  
Barcelona, Spain (Universidad de Navarra)  
CEIBS (China Europe International Business School).  
Beijing, Shanghai and Shenzhen  
Ph.D. in Mathematics  
University of Barcelona  
BA in Mathematics (Licenciatura)  
University of Barcelona

**Philip G. Moscoso**

Technology and Operations Management  
IESE Business School, University of Navarra  
Ph.D in Industrial Engineering and Management, ETH Zurich  
M.Sc. in Chemical Engineering, ETH Zurich

**Dr. Sanjay Dixit, M.D.**

Director, EP Laboratories, Philadelphia VA  
Medical Center  
Cardiovascular Medicine - Cardiac  
Arrhythmia  
Univ of Penn School of Medicine

**Dr. Han-Xiang Deng**

MD., Ph.D  
Associate Professor and Research  
Department Division of Neuromuscular  
Medicine  
Davee Department of Neurology and Clinical  
Neuroscience  
Northwestern University  
Feinberg School of Medicine

**Dr. Pina C. Sanelli**

Associate Professor of Public Health  
Weill Cornell Medical College  
Associate Attending Radiologist  
NewYork-Presbyterian Hospital  
MRI, MRA, CT, and CTA  
Neuroradiology and Diagnostic  
Radiology  
M.D., State University of New York at  
Buffalo, School of Medicine and  
Biomedical Sciences

**Dr. Roberto Sanchez**

Associate Professor  
Department of Structural and Chemical  
Biology  
Mount Sinai School of Medicine  
Ph.D., The Rockefeller University

**Dr. Wen-Yih Sun**

Professor of Earth and Atmospheric  
SciencesPurdue University Director  
National Center for Typhoon and  
Flooding Research, Taiwan  
University Chair Professor  
Department of Atmospheric Sciences,  
National Central University, Chung-Li,  
TaiwanUniversity Chair Professor  
Institute of Environmental Engineering,  
National Chiao Tung University, Hsin-  
chu, Taiwan.Ph.D., MS The University of  
Chicago, Geophysical Sciences  
BS National Taiwan University,  
Atmospheric Sciences  
Associate Professor of Radiology

**Dr. Michael R. Rudnick**

M.D., FACP  
Associate Professor of Medicine  
Chief, Renal Electrolyte and  
Hypertension Division (PMC)  
Penn Medicine, University of  
Pennsylvania  
Presbyterian Medical Center,  
Philadelphia  
Nephrology and Internal Medicine  
Certified by the American Board of  
Internal Medicine

**Dr. Bassey Benjamin Esu**

B.Sc. Marketing; MBA Marketing; Ph.D  
Marketing  
Lecturer, Department of Marketing,  
University of Calabar  
Tourism Consultant, Cross River State  
Tourism Development Department  
Co-ordinator , Sustainable Tourism  
Initiative, Calabar, Nigeria

**Dr. Aziz M. Barbar, Ph.D.**

IEEE Senior Member  
Chairperson, Department of Computer  
Science  
AUST - American University of Science &  
Technology  
Alfred Naccash Avenue – Ashrafieh

## PRESIDENT EDITOR (HON.)

---

### **Dr. George Perry, (Neuroscientist)**

Dean and Professor, College of Sciences

Denham Harman Research Award (American Aging Association)

ISI Highly Cited Researcher, Iberoamerican Molecular Biology Organization

AAAS Fellow, Correspondent Member of Spanish Royal Academy of Sciences

University of Texas at San Antonio

Postdoctoral Fellow (Department of Cell Biology)

Baylor College of Medicine

Houston, Texas, United States

## CHIEF AUTHOR (HON.)

---

### **Dr. R.K. Dixit**

M.Sc., Ph.D., FICCT

Chief Author, India

Email: [authorind@computerresearch.org](mailto:authorind@computerresearch.org)

## DEAN & EDITOR-IN-CHIEF (HON.)

---

### **Vivek Dubey(HON.)**

MS (Industrial Engineering),

MS (Mechanical Engineering)

University of Wisconsin, FICCT

Editor-in-Chief, USA

[editorusa@computerresearch.org](mailto:editorusa@computerresearch.org)

### **Sangita Dixit**

M.Sc., FICCT

Dean & Chancellor (Asia Pacific)

[deanind@computerresearch.org](mailto:deanind@computerresearch.org)

### **Suyash Dixit**

(B.E., Computer Science Engineering), FICCTT

President, Web Administration and

Development , CEO at IOSRD

COO at GAOR & OSS

### **Er. Suyog Dixit**

(M. Tech), BE (HONS. in CSE), FICCT

SAP Certified Consultant

CEO at IOSRD, GAOR & OSS

Technical Dean, Global Journals Inc. (US)

Website: [www.suyogdixit.com](http://www.suyogdixit.com)

Email: [suyog@suyogdixit.com](mailto:suyog@suyogdixit.com)

### **Pritesh Rajvaidya**

(MS) Computer Science Department

California State University

BE (Computer Science), FICCT

Technical Dean, USA

Email: [pritesh@computerresearch.org](mailto:pritesh@computerresearch.org)

### **Luis Galárraga**

J!Research Project Leader

Saarbrücken, Germany



## CONTENTS OF THE VOLUME

---

- i. Copyright Notice
- ii. Editorial Board Members
- iii. Chief Author and Dean
- iv. Table of Contents
- v. From the Chief Editor's Desk
- vi. Research and Review Papers
  1. Design of Robust Sensor Nodes to Monitor Carbon Monoxide and Natural Gas Levels. *1-5*
  2. Performance Analysis of Maximal-Ratio Combining and Equal Gain Combining in Fading Channels. *7-11*
  3. Bandwidth Enhancement of Compact Rectangular Microstrip Patch Antenna. *13-18*
  4. Comparative Study on DC Motor Speed Control using Various Controllers. *19-22*
- vii. Auxiliary Memberships
- viii. Process of Submission of Research Paper
- ix. Preferred Author Guidelines
- x. Index



GLOBAL JOURNAL OF RESEARCHES IN ENGINEERING  
ELECTRICAL AND ELECTRONICS ENGINEERING  
Volume 13 Issue 17 Version 1.0 Year 2013  
Type: Double Blind Peer Reviewed International Research Journal  
Publisher: Global Journals Inc. (USA)  
Online ISSN: 2249-4596 & Print ISSN: 0975-5861

## Design of Robust Sensor Nodes to Monitor Carbon Monoxide and Natural Gas Levels

By Elizabeth Rufus, Paritosh Sinha, Prabhat Suman & Sanket Jaiswal  
*VIT University, Oman*

*Abstract-* In the present scenario, effective real time pollution monitoring equipments require large number of nodes (preferably >50) which are capable of interaction and hence provide reliable information. Increasing the number of sensors increases the possibility of determining the exact amount of gas levels in the surrounding environment. Hence the sensor nodes and the wireless network should together work cohesively to determine the correct levels of the gas desired to be monitored. Also it is important that the sensor node has low power consumption and is robust in extreme climatic conditions. Our main focus is to develop many such sensor nodes and develop a simple protocol to effectively use them. In this paper we have only considered the design of one such node which can sense the levels of Carbon Monoxide, and hence a solid-state semiconductor Carbon Monoxide gas sensor is used. The paper describes the parameters like robustness, low power requirements and a highly efficient mode of communication to design a sensor node.

*Indexterms:* microcontroller, gas sensor.

*GJRE-F Classification :* FOR Code: 850499, 290901



*Strictly as per the compliance and regulations of :*



© 2013. Elizabeth Rufus, Paritosh Sinha, Prabhat Suman & Sanket Jaiswal. This is a research/review paper, distributed under the terms of the Creative Commons Attribution-Noncommercial 3.0 Unported License (<http://creativecommons.org/licenses/by-nc/3.0/>), permitting all non commercial use, distribution, and reproduction in any medium, provided the original work is properly cited.

# Design of Robust Sensor Nodes to Monitor Carbon Monoxide and Natural Gas Levels

Elizabeth Rufus <sup>α</sup>, Paritosh Sinha <sup>σ</sup>, Prabhat Suman <sup>ρ</sup> & Sanket Jaiswal <sup>ω</sup>

**Abstract-** In the present scenario, effective real time pollution monitoring equipments require large number of nodes (preferably >50) which are capable of interaction and hence provide reliable information. Increasing the number of sensors increases the possibility of determining the exact amount of gas levels in the surrounding environment. Hence the sensor nodes and the wireless network should together work cohesively to determine the correct levels of the gas desired to be monitored. Also it is important that the sensor node has low power consumption and is robust in extreme climatic conditions. Our main focus is to develop many such sensor nodes and develop a simple protocol to effectively use them. In this paper we have only considered the design of one such node which can sense the levels of Carbon Monoxide, and hence a solid-state semiconductor Carbon Monoxide gas sensor is used. The paper describes the parameters like robustness, low power requirements and a highly efficient mode of communication to design a sensor node.

*Indexterms:* microcontroller, gas sensor.

## 1. INTRODUCTION

The impact of pollution on the overall quality of life has been massive. Be it social or scientific, pollution has adversely affected all hemispheres of one's life. The influence of Carbon Monoxide in such circumstances cannot be ignored. The impact has been felt greatly in the developing countries where the technological advancements are leading to increasing amount of Carbon Monoxide levels. To measure the levels, these countries require not only accurate but inexpensive methods of gas detection. The proposed wireless sensor network will satisfy these requirements and provide a satisfactory solution.

Plentiful of research works have been published on the ways to develop and design sensor nodes to detect and monitor Carbon Monoxide levels in the environment. For example, [1] describes development of sensor nodes with precise calibration techniques used for accurate determination of various gas levels in the atmosphere. Although the technique used is effective for near accurate measurements, the design is not robust as the reliability of sensors is not guaranteed in harsh conditions.

Another design as described in [2] involves using a PIC microcontroller and a self-devised protocol

to establish a connection between the sensor node and a central computer system. The sensor node in the specified work contains a temperature sensor, resistive type humidity sensor, light to frequency converter, air contaminants sensor, natural Gas (methane) sensor and a Carbon Monoxide sensor. The design is tested in critical climatic conditions and found to perform with the same reliability and accuracy. But the above proposed design does not have the capability to handle a large number of nodes. For the specific task in hand, our setup requires communication among at least 50 nodes. More number of nodes will increase the possibility of accurate measurement of CO levels as sensor measurements are specific to concentration levels of CO in the vicinity of the node. To enable effective communication among a large number of sensor nodes, SimpliciTI protocol is used. SimpliciTI enable wireless communication among a maximum of 100 nodes, which is apt for our project requirements. Moreover as discussed in [1], large number of sensor nodes will allow reconstruction of pollutant flow and the density profiles of pollutants across the (3D) space.

[3] Discusses a novel technique which is used to measure Carbon Monoxide and Carbon Dioxide levels in an indoor environment using the infrared absorption principle. The proposed system also uses a PIC microcontroller for data acquisition. Our proposed design uses a MSP430F2274 microcontroller to use its capability of functioning in low power modes. The particular microcontroller has 5 low power modes to suit the requirements of the application. But the design in [3] lacks accuracy due to the relative newness of the idea. More research is required to enhance the robustness and accuracy of the sensor node. [4] Describes use of a single SB-95 sensor to detect two gases, carbon monoxide and methane. The use of sensor is unique as, the same sensor detects two different gases for two different temperatures but the response to any one particular gas is delayed, because of the lack of the ability of the sensor to detect the two gases simultaneously.

The remainder of the paper is organized as follows. Section II describes the specific characteristics the sensor node should possess for the desired application. Section III describes the selection of hardware and the algorithm of the code dumped into the nodes. Section IV displays a sample application to test the establishment and efficiency of the

*Author α:* Middle East College, Muscat, Sultanate of Oman, India.  
e-mail: elizabeth@mec.edu.om

*Authors σ ρ ω:* School of Electronics Engineering, VIT University, Vellore, India.

communication network. Section V is the conclusion and future possibilities of the paper.

## II. SENSOR NODE DESIGN REQUIREMENTS

The primary requirement of the sensor node is that it should have low power consumption. Hence hardware component selection should be done keeping in mind their compatibility with the power requirements of the node. Low power consumption will prolong the life of the node, making it apt for actual implementation.

Further to elongate the life of the node, we need to select sensors which need not be replaced in frequent intervals. For the specific application we need sensors to have a lifetime in years. Since many of the gas sensors rely on depletable reactive elements, they need to be replaced more than once a year. This makes them undesirable for our specific application. Also we need to keep in mind the fact that the design requires a collection of greater than 50 nodes which necessitates use of low cost sensors. All these factors will be taken into consideration while selecting the sensor for our application.

To enhance the robustness of the sensor node, it is important that the sensor is responsive at high temperatures, in the range of  $-20^{\circ}\text{C}$  to  $50^{\circ}\text{C}$ . This temperature range will be suitable for our design because most of the environmental conditions will be in this particular temperature range.

The last requirement of the sensor node is to have a two way communication with the central computer system. This will allow the user to control the inaccessible sensor node from a distant location in case of varying environmental conditions. Also the user will have the capability of disabling the sensor nodes in case of an emergency like horrid weather conditions or natural calamities.

## III. TEST MODULE, CODING ALGORITHM AND HARDWARE SELECTION

To test the working our proposed design, we intend to use evaluation module EZ430-RF2500 provided by Texas Instruments. The module contains a set of two target boards, one assigned as access point and the other as end device. The access point target board is connected to central computer system using a USB port. The USB port provides the power supply for the access point. The end device is powered by two AAA batteries, each 1.5V. The module EZ430-RF2500 has an inbuilt temperature sensor which provides accurate readings in the range of  $\pm 0.1^{\circ}\text{C}$ . Each target board consists of the following components.

- A microcontroller (MSP430F2274)
- A RF transceiver chip (CC2500)
- A chip antenna

The evaluation module also contains a software simulator (IAR embedded workbench) to debug and dump the code into the target boards. The module uses SimpliciTI protocol to develop RF communication among the target boards. The protocol can easily handle 100 nodes or more and hence is perfect for our particular application. The protocol provides with the option of using range extenders to increase the detection range of the target boards. The range extension can be done up to 4 hops. The communication topology used in the SimpliciTI protocol depends upon the target boards which are active. If both the access point and end device are in ON condition, store and forward peer to peer protocol is used. Else when only end devices are in ON condition, peer to peer protocol is used. The major advantage of using the SimpliciTI protocol is that there is very less latency in the response to the input from sensor nodes. Also as mentioned earlier, the protocol can handle large number of nodes which will help us in carrying out the reconstruction of pollutant flow and the density profiles of pollutants across the (3D) space.

Now we will be discussing the various components which are going to be used in the sensor node. Following is the block diagram of the proposed design for our sensor nodes.

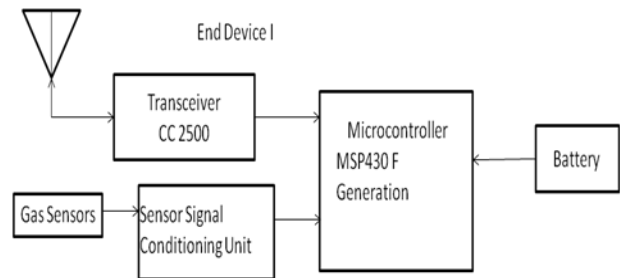

Figure 1 : Block diagram for end device

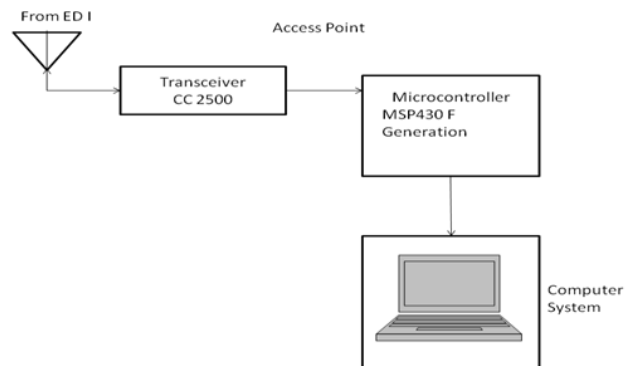

Figure 2 : Block diagram for access point

For each of the sensor nodes we require a processing unit, which is fulfilled by using a MSP430F2274. MSP430F2274 is an ultra low power consuming microcontroller which contains two

configurable operational amplifiers. The microcontroller has one active and five software selectable modes of operation. Low power mode 3 is selected for the microcontroller in which the CPU, Main Clock and the Sub-Main Clock are disabled. The Auxiliary Clock is the only clock which is active. The microcontroller also contains a 10-bit A/D with integrated reference which will be very useful to convert the received analog values from the Carbon Monoxide gas sensor into microcontroller compatible digital values. Additionally, the microcontroller has an exceptional capability of waking up from standby mode in less than 0.1  $\mu$ s. All these specifications make the MSP430F2274 a perfect choice for our application.

RF transceiver chip CC2500 is used for the purpose of communication among the nodes. CC2500 is a low cost low power RF transceiver which is suitable for most of the common day applications. It operates in the 2400-2483.5 MHz ISM/SRD band system. The chip operates in the range of -40oC to 85oC which increases the robustness of our sensor node. Also the CC2500 has a built in analog temperature sensor, which assists in reducing the cost of the sensor node, simultaneously providing us with the option of monitoring a new physical parameter. Additionally, the chip has low current consumption and high sensitivity.

The code which is dumped into the target boards of EZ430-RF2500 too are of immense importance, as they provide possibilities of increasing the accuracy and decreasing the power consumption of the sensor nodes. To understand the code we need to know that both access point and end device have separate codes dumped into them. Due to limited hardware semaphores are used, which enable maximum extraction out of the possible hardware. The factory code contains 3 semaphores sJoinSem, sSelfMeasureSem and sPeerFrameSem. The function of semaphore is to limit the hardware to only one specific function at any particular time. This means that if at any moment, anyone of the semaphore is set, the other two have to be low.

The three semaphores are used for three different purposes. The semaphore sJoinSem is set every time an end device attempts to join the network. The semaphore sPeerFrameSem is set when the end device sends a frame to the access point. These frames contain the data acquired from the Carbon Monoxide sensor. The semaphore sSelfMeasureSem is set when the access point needs to measure the temperature using its inbuilt temperature sensor. Since our central computer systems do not require an interface with the gas sensor, we can ignore and remove the sSelfMeasureSem semaphore to increase the efficiency of our code. The semaphore technique increases the responsiveness of the network as all the end devices can attach themselves to the network at any point of time.

The flowchart below describes the code algorithm for the access point node. As described before, setting high of a semaphore depends on the activity shown from the end device. Thus the code is responsive to any activity from the end device at any point of time, decreasing the latency in the network.

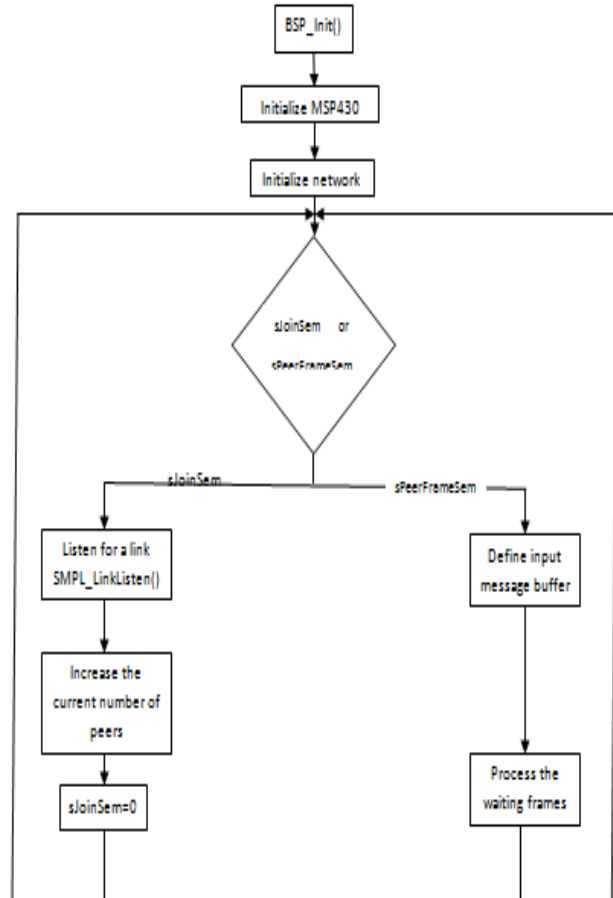

Figure 3 : Algorithm for Access Point

#### IV. WORKING AND DISCUSSION

To test the response of our network, we used the evaluation module EZ430-RF2500. Input was fed from the end device using switches, response to which was viewed on a laptop and also simultaneously using two LEDs.

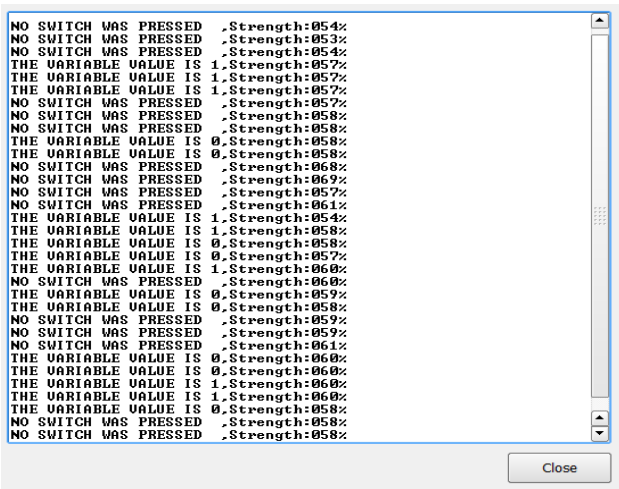

Figure 4 : Output at the console window

Figure [4] shows the console window of EZ430-RF2500 sensor monitor software. It acts like a HyperTerminal window for the output of the access point.

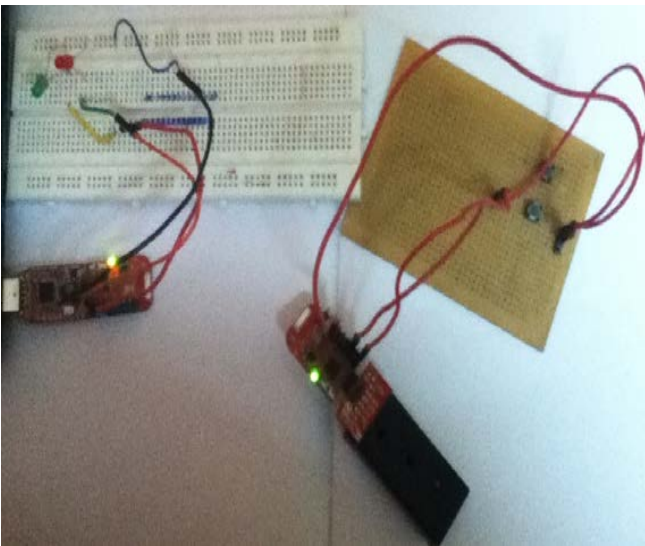
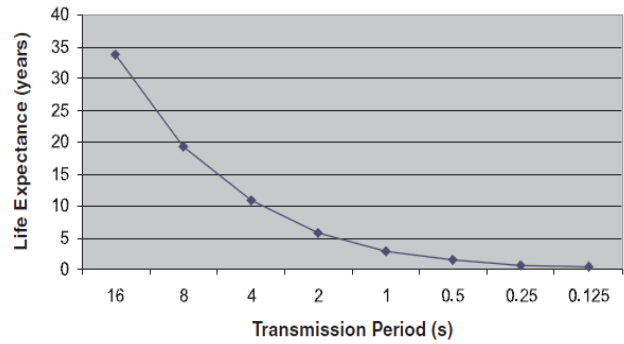

Figure 5 : Hardware Setup

In figure[5] we notice two target boards. The target board on the right, from where the input is provided using switches, is the end device. The target board on the left is the access point. The end device transmits the value of 0 or 1 depending upon the input given from the switch. The same Input is later reflected on the console window, displaying the values of 0 or 1. The red and green LEDs glow separately in response to the different input values provided by the end device. If no input is provided, the console window displays the default message “NO SWITCH WAS PRESSED”. Also each message contains information about the received signal strength from the end device. These values can be used to estimate (but not accurately determine) the

distance of the sensor node from the central computer system or the access point.



Life expectance vs. Transmission Period [13]

Life expectancy of the sensor node is a very essential characteristic for our specific application. Increasing the lifetime of the sensor node would imply less frequent replacement of power supply sources at the remote areas where the sensor node is established. The above graph displays a technique which can be used to increase the lifetime of the sensor node. If the time difference between two transmissions is increased, the life expectancy of the sensor nodes can be stretched to 40 years [13].

## V. CONCLUSION

This paper presents a technique to design robust sensors with increased lifetimes. The ability of the sensor network to handle a large number of nodes will help in carrying out various processes of environment monitoring like reconstruction of pollutant flow and the density profiles of pollutants across the space. Hence the technique provides new opportunities to explore new ways of monitoring the gaseous pollutants, especially carbon monoxide in the air space. In the same way any other parameter may be efficiently detected by developing an appropriate sensing node. Although the fabrication results are not provided, actual implementation of this technique will help by providing more insights on ways to improve the accuracy of the readings of the carbon monoxide sensor, while simultaneously keeping the cost factor to a minimum.

## VI. ACKNOWLEDGEMENT

The facilities offered in the Electronics Laboratory in VIT University are thankfully acknowledged.

## REFERENCES RÉFÉRENCES REFERENCIAS

1. Lamling VenusShum, Pachamuthu Rajalakshmi, Ayo Afonja, Graeme McPhillips, Russell Binions, Lawrence Cheng, Stephen Hailes,” On the Development of a Sensor Module for real-time Pollution Monitoring”.

2. Dipanjan Bhattacharjee, Sourabh Kumar, Akash Kumar, Sushabhan Choudhury, "Design and Development of Wireless Sensor Node", Dipanjan Bhattacharjee et. al. / (IJCSSE) International Journal on Computer Science and Engineering Vol. 02, No. 07, 2010, 2431-2438.
3. Marianah Masrie, Anuar Ahmad and Ramli Adnan "A Novel Integrated Sensor System for Indoor Air Quality Measurement".
4. Emil Cordos, Ludovic Ferenczi, Sergiu Cadar, Simona Costiug, Gabriela Pitl, Adrian Aciu, Adrian Ghita," Methane and Carbon Monoxide Gas Detection system based on semiconductor sensor
5. S.Nagata, M.Matsuno, K.Ogino and H.Takashima, "Carbon Monoxide Detector Unit",Yazaki Meter Corp., Gas Equipment Development Division 23 Minamikajima, Futamata-chou, Tenryuu-shi, Shizuoka-ken 431 -33.
6. Y. Ishiguro, T. Suzuki, Y. Nagawa, O. Kino," Gas Sensors For Environment Monitoring", Gas Equipment Development Division 23 Minamikajima, Futamata-chou, Tenryuu-shi, Shizuoka-ken 431 -33.
7. A. Oprea, N. Bârsan, U. Weimar, J. Courbat, D. Briand, N.F. de Rooij, "Integrated Temperature Humidity and Gas Sensors on Flexible Substrates for Low-Power Applications".
8. S.Bicelli , A.Flammini , A. Depari , D. Marioli , A. Ponzoni , G.Sberveglieri , A. Taroni, "Low-Power Carbon Monoxide MOX Sensors for Wireless Distributed Sensor Networks".
9. Joseph E. Chilton and Clarence R. Carpenter, "A Miner's Personal Carbon Monoxide Alarm".
10. Chu Heng He, Samir El-Kilani, and Milutin Stanacevic, "Mobile Gas Sensor and Source Detector".
11. Abdellah Chehri, Wissam Farjow, Hussein. T. Mouftah, Xavier Fernando,"Design of Wireless Sensor Networks for Mine Safety Monitoring".
12. Octavian Postolache, Pedro Girao, Miguel Pereira, "Neural Network Application in a Carbon Monoxide Measurement System".
13. Miguel Morales, "Wireless Sensor Monitor Using the eZ430-RF2500" Application Report SLAA378B–December 2007–Revised September 2008 By Texas Instruments".
14. Yang Lijian, Liu Gang, Zhang guoguang, Gao Songwei, "Sensor Development and Application on the oil-gas pipeline Magnetic Flux Leakage Detection".

This page is intentionally left blank





GLOBAL JOURNAL OF RESEARCHES IN ENGINEERING  
ELECTRICAL AND ELECTRONICS ENGINEERING  
Volume 13 Issue 17 Version 1.0 Year 2013  
Type: Double Blind Peer Reviewed International Research Journal  
Publisher: Global Journals Inc. (USA)  
Online ISSN: 2249-4596 & Print ISSN: 0975-5861

## Performance Analysis of Maximal-Ratio Combining and Equal Gain Combining in Fading Channels

By Sohag Sarker, Tanzila Lutfor & Md. Zahangir Alam

*Pabna University of Science and Technology, Bangladesh*

**Abstract-** In this paper, the performance of a single-input-multiple-output (SIMO) scheme is analyzed under Rayleigh and Rician fading channel using Maximal-Ratio Combining (MRC) and Equal Gain Combining (EGC). In this scheme, a single transmit antenna, which maximizes the total received signal power at the receiver is used and number of received antenna is varied to analyze performance. The Bit Error rate(BER) using two combining techniques under fading channels is derived for BPSK, QPSK and 16-QAM.

**Keywords:** *rayleigh fading, rician fading, maximal-ratio combining, and equal gain combining.*

**GJRE-F Classification :** *FOR Code: 090699*



*Strictly as per the compliance and regulations of :*



# Performance Analysis of Maximal-Ratio Combining and Equal Gain Combining in Fading Channels

Sohag Sarker <sup>α</sup>, Tanzila Lutfor <sup>σ</sup> & Md. Zahangir Alam <sup>ρ</sup>

**Abstract-** In this paper, the performance of a single-input-multiple-output (SIMO) scheme is analyzed under Rayleigh and Rician fading channel using Maximal-Ratio Combining (MRC) and Equal Gain Combining (EGC). In this scheme, a single transmit antenna, which maximizes the total received signal power at the receiver is used and number of received antenna is varied to analyze performance. The Bit Error rate(BER) using two combining techniques under fading channels is derived for BPSK, QPSK and 16-QAM.

**Keywords:** rayleigh fading, rician fading, maximal-ratio combining, and equal gain combining.

## I. INTRODUCTION

In wireless communications, radio propagation refers to the behavior of radio waves when they are propagated from transmitter to receiver through medium [1]. The transmission path between the transmitter and receiver can vary from simple line-of-sight to one that is severely obstructed by buildings, mountains, and foliage which cause reflection, diffraction, and scattering[2]. The wireless channel environment mainly governs the performance of wireless communication systems. The wireless channel is dynamic and unpredictable rather than the typically static and predictable characteristics of a wired channel which make an exact analysis of the wireless communication system often difficult. A unique characteristic in a wireless channel is a phenomenon called 'fading', the rapid fluctuations of the signal amplitude over time and frequency. In addition to AWGN, fading is another source of signal degradation that is characterized as a non-additive signal disturbance in the wireless channel. Fading may either be multi-path (induced) fading, which is due to multipath propagation, or shadow fading which is due to shadowing from obstacles that affect the propagation of a radio wave. The fading phenomenon in the wireless communication channel is modeled for 800MHz to 2.5 GHz by extensive channel measurements in the field. Includes the ITU-R standard channel models specialized

for SISO. The MIMO (Multiple Input Multiple Output), MISO (Multiple Input Single Output), and SIMO (Single Input Multiple Output) systems have been recently developed by the various research and standardization activities, aiming at high-speed wireless transmission and diversity gain [3] which improves the performance of the communication links over radio fading channels[1]. The basic concept of diversity is that if one signal path is weak at a particular point of time, another independent path may be just fine. Here receiver is provided with multiple copies of the same information signal which are transmitted over two or more real or virtual communication channels. Thus it can be considered as the diversity is the repetition or redundancy of information [4].

Diversity-combining techniques are often used to combat the deleterious effect of channel fading [5,6]. Maximal ratio combining (MRC) or equal-gain combining (EGC) are widely applied to reduce the system bit error rate (BER) [6].

The relative advantage of diversity is greater for Rayleigh fading than Rician fading, because as the Rice factor  $K$  increases there is less difference between the instantaneous received signal-to-noise ratios on the various diversity branches [7]. However, the performance will always be better with Rician fading than with Rayleigh fading, for a given average received signal-to-noise ratio and diversity order.

## II. SYSTEM MODEL

Let us consider the transmission of the band-pass signal,

$$s(t) = \text{Re}[\tilde{s}(t)e^{j2\pi f_c t}] \quad (1)$$

where,  $\tilde{s}(t)$  = complex envelope of transmitted signal,  $f_c$  = carrier frequency,  $\text{Re}[z]$  = real part of  $z$ . If the channel is composed of  $N$  propagation paths, then the noiseless received band pass waveform is

$$r(t) = \text{Re}\left[\sum_{n=1}^N C_n e^{j2\pi(f_c + f_{D,n})(t - \tau_n)} \tilde{s}(t - \tau_n)\right] \quad (2)$$

where,  $C_n$  is the amplitude of  $n^{\text{th}}$  propagation path,  $\tau_n$  is time delay associated with  $n^{\text{th}}$  propagation path.

*Author α:* Department of Information and Communication Engineering, Pabna University of Science and Technology, Pabna-6600, Bangladesh. e-mail: sohagsarker5614@gmail.com

*Authors σ ρ:* School of Science and Engineering, University of Information Technology and Sciences (UITS), Dhaka, Bangladesh. e-mail: ripon83.ru@gmail.com

Now, the received band pass signal,

$$r(t) = \text{Re}[\tilde{r}(t)e^{j2\pi f_c t}] \tag{3}$$

where, the received complex envelope,

$$\tilde{r}(t) = \sum_{n=1}^N C_n e^{-j\varphi_n(t)} \tilde{s}(t - \tau_n) \tag{4}$$

$$\varphi_n(t) = 2\pi\{(f_c + f_{D,n})\tau_n - f_{D,n}t\} \tag{5}$$

Now, the channel impulse response,

$$g(t, \tau) = \sum_{n=1}^N C_n e^{-j\varphi_n(t)} \delta(\tau - \tau_n) \tag{6}$$

where  $g(t, \tau)$  is the channel response at time  $t$  due to an impulse applied at time  $t - \tau$ ,  $\delta(\cdot)$  is the dirac delta function [4].

Here, the channel assumed to be wide sense stationary (WSS), so the received complex envelope  $g(t) = g_i(t) + jg_q(t)$ ; where,  $g_i(t)$  and  $g_q(t)$  are independent identically distributed zero mean Gaussian random variables at time  $t_1$  with variance  $b_0$ . Under these conditions, the received complex envelope's magnitude  $\alpha(t) = |g(t)|$  has a Rayleigh distribution at any time  $t_1$ , that is  $P_\alpha(x) = \frac{x}{b_0} \exp\{-\frac{x^2}{2b_0}\}$ . The average envelope power is  $E[\alpha^2] = \Omega_p = 2b_0$ . So, for Rayleigh distribution,

$$P_\alpha(x) = \frac{2x}{\Omega_p} \exp\{-\frac{x^2}{\Omega_p}\} \quad (x \geq 0) \tag{7}$$

For Rician fading, line of sight (LoS) component will be present; so equation (7) can be re-written for Rician channel as:

$$P_\alpha(x) = \frac{2x}{\Omega_p} \exp\{-\frac{x^2 + s^2}{2b_0}\} I_0(\frac{xs}{b_0}) \quad (x \geq 0) \tag{8}$$

where,  $s^2 = m_i^2(t) + m_q^2(t)$

Where,  $m_i(t)$  and  $m_q(t)$  corresponds to in-phase and quadrature component of LoS signal as:

$$m_i(t) = s \cdot \cos(2\pi f_m \cos \theta_0 t + \phi_0)$$

$$m_q(t) = s \cdot \sin(2\pi f_m \sin \theta_0 t + \phi_0)$$

where,  $f_m \cos \theta_0$  and  $\phi_0$  are the Doppler shift and random phase off set associated with the LoS or specular component, respectively. The Rice factor ( $K$ ) is the ratio of the specular power  $s^2$  to scattered power  $2b_0$ , that is,  $K = s^2/2b_0$ . When  $K = 0$  the channel exhibits Rayleigh fading, and when  $K = \infty$  the channel does not exhibit any fading at all [7].

a) Maximal Ratio Combiner (MRC)

In MRC, each signal branch is multiplied by a weight factor that is proportional to the signal amplitude. Signals from all the MR branches are weighted according to their individual SNR and then summed.

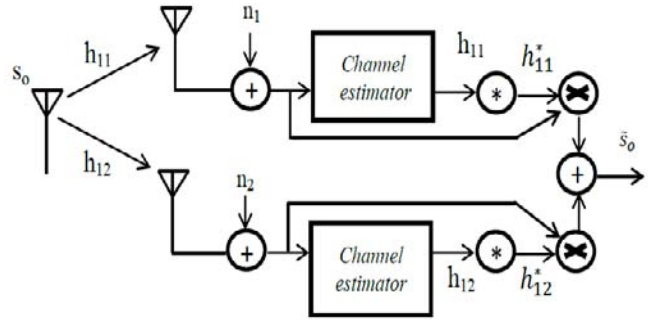

Figure 1 : MRC with 1 Tx and 2 Rx

Our system, as indicates in fig-1, modeled with 1 transmitter and 2 receivers. The symbol to be transmitted is weighted with transmit weighting vector to form the transmitted signal vector. Thus the resulting receive signal can be represented as [1]:

$$\tilde{r}_1 = h_{11} \tilde{s}_0 + n_1 \tag{9}$$

$$\tilde{r}_2 = h_{12} \tilde{s}_0 + n_2 \tag{10}$$

Where,  $h_{11}$  and  $h_{12}$  represents the channel coefficients for receive antenna 1 and 2 respectively at time  $t$  and,  $n_1$  and  $n_2$  represents additive white Gaussian noise with zero mean and unit variance [8]. The combined signal can be written as:

$$\hat{s}_o = h_{11} * \tilde{r}_1 + h_{12} * \tilde{r}_2 \tag{11}$$

This system, particularly designed for 1 Transmitter antenna and L Receiver Antennas. Thus the channel consists of  $1 * L$  statistically independent coefficients which form the channel matrix  $\mathbf{h} = [h_{11} \ h_{12} \ \dots \ h_{1L}]^T$ . Then the received signal vector can be written as the product of the Transmitted signal and the channel coefficient plus noise.

$$\tilde{\mathbf{r}} = \mathbf{h} * \mathbf{x} + \mathbf{n} \tag{12}$$

where,  $\tilde{\mathbf{r}} \triangleq (\tilde{r}_1, \tilde{r}_2, \dots, \tilde{r}_L)^T$ , the noise vector  $\mathbf{n} = [n_1, \dots, n_L]^T$ . Here, the noise is assumed to be uncorrelated and white Gaussian with the signal [5].

As it is inevitable that MRC realizes Maximum Likelihood (ML) detector, the receiver chooses the message vector  $\tilde{\mathbf{s}}_m$  that maximizes the metric,

$$\begin{aligned} \mu(\tilde{\mathbf{s}}_m) &= -\sum_{k=1}^L \|\tilde{\mathbf{r}}_k - h_{1k} \tilde{\mathbf{s}}_m\|^2 \\ &= -\sum_{k=1}^L \{ \|\tilde{\mathbf{r}}_k\|^2 - 2\text{Re}(h_{1k}^* \tilde{\mathbf{r}}_k, \tilde{\mathbf{s}}_m) + |h_{1k}|^2 \|\tilde{\mathbf{s}}_m\|^2 \} \end{aligned} \tag{13}$$

The diversity combiner generates the sum

$$\tilde{\mathbf{r}} = \sum_{k=1}^L h_{1k}^* r_k \tag{14}$$

After weighting, co-phasing and combining, the envelope of the composite signal component can be written as:

$$\alpha_M = \sum_{K=1}^L \alpha_K^2 \tag{15}$$

The weighted sum of the branch noise power is

$$\sigma_{\tilde{n},tot}^2 = N_0 \sum_{k=1}^L \alpha_k^2 \tag{16}$$

Hence the symbol energy to noise ratio is

$$\gamma_s^{mr} = \frac{\alpha_M^2 E_{av}}{\sigma_{\tilde{n},tot}^2} = \sum_{K=1}^L \frac{\alpha_k^2 E_{av}}{N_0} = \sum_{k=1}^L \gamma_K \tag{17}$$

where  $E_{av}$  is the average symbol energy in the signal constellation.

Here, it is assumed that all antennas are balanced and uncorrelated and  $\gamma$  has a chi-squared distribution with  $2L$  degrees of freedom i.e.,

$$p_{\gamma_s}^{mr}(x) = \frac{1}{(L-1)! (\bar{\gamma}_c)^L} x^{L-1} e^{-x/\bar{\gamma}_c} \tag{18}$$

Where,  $\bar{\gamma}_c = E[\gamma_k]$ ;  $k=1, \dots, L$  (19)

For BPSK the bit error rate can be repressed as:

$$P_b = \int_0^\infty P_b(x) P_\gamma(x) dx \tag{20}$$

$$= \int_0^\infty Q(\sqrt{2x}) \frac{1}{(L-1)! (\bar{\gamma}_c)^L} x^{L-1} e^{-x/\bar{\gamma}_c} dx$$

Similarly, bit error rate for M-QAM as follows [ 9 ] :

$$P_{QAM} = 1 - (1 - P_{QAM, Rician, \sqrt{M}})^2 \tag{21}$$

where,

$$P_{QAM, Rician, \sqrt{M}} = (1 - \frac{1}{\sqrt{M}}) \sum_{n=0}^\infty \frac{(LK)^n e^{-LK}}{\Gamma(n+1)} * \left[ 1 - \sum_{i=0}^{L+n-1} \mu \left( \frac{1-\mu^2}{4} \right)^i \binom{2i}{i} \right]$$

$$\text{and } \mu = \sqrt{\frac{3\bar{\gamma}_s}{2M - 2 + 3\bar{\gamma}_s}}$$

*b) Equal Gain Combiner(EGC)*

The similarity between EGC and MRC is that in both cases diversity branches are co-phased, but for EGC diversity branches are not weighted. The complete

channel vector is required anyway and MRC might as well be used. In EGC, the receiver maximizes the metric

$$\mu(\tilde{\mathbf{s}}_m) = \sum_{k=1}^L \text{Re}(\tilde{\mathbf{r}}_k e^{-j\phi_k}, \tilde{\mathbf{s}}_m) = \sum_{k=1}^L \text{Re} \left( e^{-j\phi_k} \int_0^T \tilde{\mathbf{r}}_k(t) \tilde{\mathbf{s}}_m^*(t) dt \right) \tag{22}$$

The combiner generates the sum

$$\tilde{\mathbf{r}} = \sum_{k=1}^L e^{-j\phi_k} \tilde{\mathbf{r}}_k \tag{23}$$

The envelope of the composite signal, after co-phasing and combining, is

$$\alpha_E = \sum_{k=1}^L \alpha_k \tag{24}$$

And  $LN_0$  is the sum of branch powers. The resulting symbol energy-to-noise ratio is

$$\gamma_s^{eg} = \frac{\alpha_E^2 E_{av}}{LN_0} \tag{25}$$

With EGC, the average symbol energy-to-noise ratio is

$$\tilde{\gamma}_s^{eg} = \frac{E_{av}}{LN_0} E \left[ \left( \sum_{k=1}^L \alpha_k \right)^2 \right] \tag{26}$$

$$= \frac{E_{av}}{LN_0} \sum_{i=1}^L \sum_{l=1}^L E[\alpha_k \alpha_l]$$

The bit error probability, with coherent BPSK signaling, is

$$P_b = \int_0^\infty P_b(x) P_{\gamma_s^{eg}}(x) dx \tag{27}$$

$$= \frac{1}{2} (1 - \sqrt{1 - \mu^2})$$

where  $\mu = \frac{1}{1 + \bar{\gamma}_c}$

The Probability of error can be expressed as the following equation as well:

$$P_s = \frac{1}{\pi} \int_0^\infty \text{Re} al \{ G(\omega) \phi_x^*(\omega) \} d\omega \tag{28}$$

The formula can be calculated using Gauss-Chebyshev quadrature (GCQ)

$$G(\omega) = \frac{1}{\sqrt{\pi\omega}} \times \left\{ F\left(\frac{\omega}{2\sqrt{\kappa_2}}\right) - \exp\left(\frac{-\omega^2}{4\kappa_2} \sin^2(\eta)\right) \times F\left(\frac{\omega \cos(\eta)}{2\sqrt{\kappa_2}}\right) \right\} + j\omega \frac{1}{2\pi} \int_0^\eta \frac{\sin^2(\theta)}{\kappa_2} \times \phi\left(1, \frac{3}{2}; \frac{-\omega^2 \sin^2(\theta)}{4\kappa_2}\right) d\theta \tag{29}$$

Where,  $\eta = \pi - \pi/4$  and  $\kappa_2 = \sin^2(\pi/4)$  and  $F(\cdot)$  denotes Dawson's integral. [10]

### III. SIMULATION RESULTS

In this section, we discussed the simulation results of the BER Vs SNR performance of BPSK, QPSK and 16-QAM modulation schemes with MRC and EGC diversity combining techniques over Rayleigh and Rician fading channels using one or more receiving antennas with the help of MATLAB.

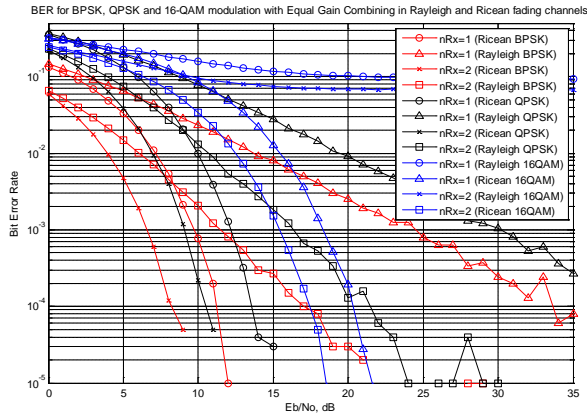

Figure 1 : BER for BPSK,QPSK and 16-QAM modulation schemes with Equal Gain Combining technique in Rayleigh and Rician fading channels

In Figure 1, it is observable that at very low SNR value area, the system performance is comparatively better under deployment of BPSK and Rician fading channel with Equal Gain Combining technique. It is also observable that with increasing number of receiving antennas BER is decreasing significantly.

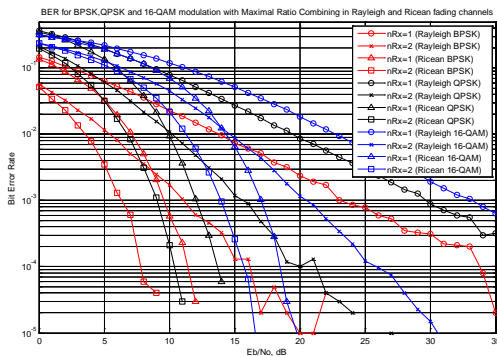

Figure 2 : BER for BPSK,QPSK and 16-QAM modulation schemes with Maximal Ratio Combining Technique in Rayleigh and Rician fading channels

In Figure 2, it is observed that with Maximal Ratio Combining technique, BPSK performs comparatively better than QPSK with Rician fading channel. It is also observable that BER decreases significantly with increasing number of receiving antennas.

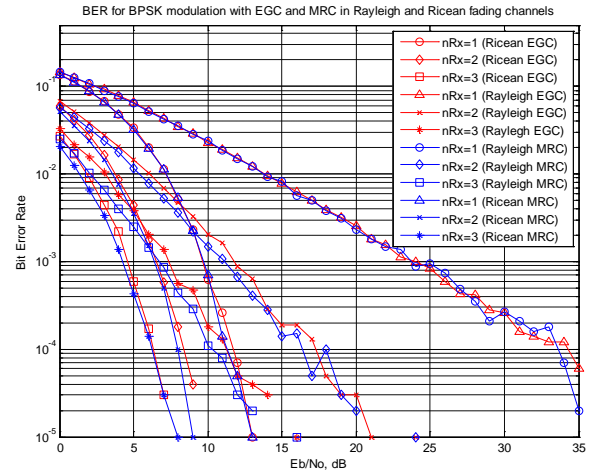

Figure 3 : BER for BPSK modulation schemes with EGC and MRC in Rayleigh and Rician fading channels

Figure 3 shows the BER for BPSK modulation schemes with EGC and MRC in Rayleigh and Rician fading channels. We observed that with single receiving antenna BER for BPSK is same in both Maximal Ratio Combining technique and Equal Gain Combining technique. With two or more receiving antennas Maximal Ratio Combining technique performs better than Equal Gain Combining technique with BPSK.

### IV. CONCLUSION

In this paper, we have investigated simulation results of Maximal ratio combining and Equal Gain Combining under Rayleigh and Rician fading channels using various modulation techniques. In the context of system performance, it can be concluded that BPSK Maximal Ratio Combining technique gives satisfactory results than Equal Gain Combining. The results presented in this paper are expected to provide useful information and guidelines to radio systems design engineers to exploit the use of diversity combining under realistic imperfect channel estimation scenarios.

### REFERENCES RÉFÉRENCES REFERENCIAS

1. Suvarna P. Jadhav, Vaibhav S. Hendre, "Performance of Maximum Ratio Combining(MRC) MIMO Systems for Rayleigh Fading channels", International Journal of Scientific and Research Publications, Volume 3, Issue 2, February 2013, ISSN 2250-3153.
2. Amir Ali Basri, "Wireless Communication over Fading Channels with Imperfect Channel Estimates".
3. Book, "MIMO-OFDM Wireless Communications with MATLAB" by Yong Soo Cho, Jaekwon Kim, Won Young Yang and Chung G. Kang.
4. Srivastava N., "Diversity schemes for wireless communication a short review", Journal of

- Theoretical and Applied Information Technology, vol.15, no.2, pp.134-143, 2010.
5. J. G. Proakis, Digital Communications, 4 ed. McGraw-Hill, New York, 2000.
  6. R. You, H. Li and Y. Bar-Ness, "Diversity combining with channel estimation", IEEE Trans. Commun., vol.53, No.10, pp.1655-1662, October 2005.
  7. Principles of mobile communication, second edition, by Gordon L. Stuber.
  8. Performance analysis for optimum transmission and comparison with maximal ratio transmission for MIMO systems with cochannel interference, Lin EURASIP Journal on Wireless Communications and Networking, 2011.
  9. Jawad Ali, Performance of MRC and EGC Antenna Diversity Reception for M-QAM over Rician Fading Environment with PSAM and LMME Channel Estimation, <http://www.emo.org.tr/ekler/71cf2f00d966e2c>
  10. A. Annamalai, C. Tellambura and Vijay K.Bhargava, "Equal gain Diversity Receiver Performance in Wireless Channel", IEEE Transaction on communication, vol.48, No. 10., October 2000.

This page is intentionally left blank



GLOBAL JOURNAL OF RESEARCHES IN ENGINEERING  
ELECTRICAL AND ELECTRONICS ENGINEERING  
Volume 13 Issue 17 Version 1.0 Year 2013  
Type: Double Blind Peer Reviewed International Research Journal  
Publisher: Global Journals Inc. (USA)  
Online ISSN: 2249-4596 & Print ISSN: 0975-5861

## Bandwidth Enhancement of Compact Rectangular Microstrip Patch Antenna

By Vivek Singh Rathor & J. P. Saini

*MEWAR University, India*

**Abstract-** A compact single feed rectangular microstrip patch antenna using dielectric substrate 4.2, loss tangent .0012 and having substrate height of 1.6 is used. The compact antenna of dimension (14mm X 18.6mm X 1.6mm) is used and analyzed on MoM based simulating software IE3D. A probe of different radius has been taken to improve the Bandwidth of the proposed structure. Simulation results show that antenna can realize wide band characteristics and single band of 4.148 GHz (impedance bandwidth of 76.53%) has been achieved.

**Keywords:** *microstrip antenna, wide band, band width enhancement, probe radius, IE3D.*

**GJRE-F Classification :** *FOR Code: 291701, 290903p*



*Strictly as per the compliance and regulations of :*



© 2013. Vivek Singh Rathor & J. P. Saini. This is a research/review paper, distributed under the terms of the Creative Commons Attribution-Noncommercial 3.0 Unported License (<http://creativecommons.org/licenses/by-nc/3.0/>), permitting all non commercial use, distribution, and reproduction in any medium, provided the original work is properly cited.



# Bandwidth Enhancement of Compact Rectangular Microstrip Patch Antenna

Vivek Singh Rathor<sup>α</sup> & J. P. Saini<sup>σ</sup>

**Abstract-** A compact single feed rectangular microstrip patch antenna using dielectric substrate 4.2, loss tangent .0012 and having substrate height of 1.6 is used. The compact antenna of dimension (14mm X 18.6mm X 1.6mm) is used and analyzed on MoM based simulating software IE3D. A probe of different radius has been taken to improve the Bandwidth of the proposed structure. Simulation results show that antenna can realize wide band characteristics and single band of 4.148 GHz (impedance bandwidth of 76.53%) has been achieved.

**Keywords:** microstrip antenna, wide band, band width enhancement, probe radius, IE3D.

## I. INTRODUCTION

Microstrip patch antennas are popular for their well-known attractive features of low profile, light weight, and compatibility with monolithic microwave integrated circuits (MMICs). Because of their attractive feature they are in great demand in wireless communication applications. The main disadvantage of this microstrip antenna narrow bandwidth, which is due to the resonant nature of the patch structure.[4] Conventional microstrip antennas in general have a conducting patch printed on a grounded microwave substrate, and have the attractive features of low profile, light weight, easy fabrication, and conformability to mounting hosts.[1] However, conventional microstrip patch antenna suffers from very narrow bandwidth, typically about 5% bandwidth with respect to the center frequency. This poses a design challenge for the microstrip antenna designer to meet the broadband techniques [3]. To overcome this problem of narrow bandwidth, many proposals and techniques have been analyzed and investigated such as probe fed stacked antenna, microstrip patch antennas on electrically thick substrate, slotted patch antenna and stacked shorted patches, the use of various impedance matching and feeding techniques, the use of multiple resonators. [14] The development of antenna for wireless communication also requires an antenna with more than one operating frequency. This is due to many reasons, mainly because there are various wireless communication systems and many telecommunication operators using various frequencies. Therefore one antenna that has multiband characteristic is more

desirable than having one antenna for each frequency band. [7] Our aim is to increase the operating bandwidth the simulation has been carried out by IE3D.

So we want an antenna which offers a low profile, wide bandwidth, compact antenna element. Among these standards, the following frequency bands can be mentioned: (1) PCS-1900 requires a band of 1.85–1.99 GHz; (2) IEEE 802.11b/g requires a band of 2.4–2.484 GHz; (3) IEEE 802.11a requires a band of 5.15–5.35 GHz and an additional band of 5.725–5.825 GHz; (4) HiperLAN2 requires a band of 5.47–5.725 GHz besides the band of 5.15–5.35 GHz. [2, 6, 7, 12]

To overcome the above problem, a microstrip antenna structure with a typical Kite symbol shaped patch is proposed which exhibits good enhanced impedance bandwidth of up to 76.53% depending upon the radius of probe.

## II. ANTENNA DESIGN

The dielectric constant of the substrate is closely related to the size and the bandwidth of the microstrip antenna. Low dielectric constant of the substrate produces larger bandwidth, The resonant frequency of microstrip antenna and the size of the radiation patch can be similar to the following formulas while the high dielectric constant of the substrate results in smaller size of antenna [1].The Length of ground plane of Antenna is 24 mm and Width is 28.2 mm, L & W of the patch is 14 mm & 18.6 mm the radius of the coaxial probe feed is taken as 0.5 mm. The material used for substrate is glass epoxy with dielectric constant of 4.2, loss tangent .0012 and substrate height of 1.6 mm. The proposed structure is shown in fig 1.

The patch width, effective dielectric constant, the length extension and also patch length are given by

$$W = \frac{c}{2f\sqrt{\epsilon_r}} \quad (1)$$

where  $c$  is the velocity of light,  $\epsilon_r$  is the dielectric constant of substrate,  $f$  is the antenna working frequency,  $W$  is the patch non resonant width, and the effective dielectric constant is  $\epsilon_{eff}$  given as,

$$\epsilon_{eff} = \frac{(\epsilon_r + 1)}{2} + \frac{(\epsilon_r - 1)}{2} \left[ 1 + 10 \frac{H}{W} \right]^{-\frac{1}{2}} \quad (2)$$

Author  $\alpha$ : Research Scholar, MEWAR University, Rajasthan, India.  
e-mail: vivek\_rathor@rediffmail.com

Author  $\sigma$ : Principal, Madan Mohan Malviya Engineering College, Gorakhpur (U.P), India. e-mail: jps\_uptu@rediffmail.com

The extension length  $\Delta$  is calculates as,

$$\frac{\Delta L}{H} = 0.412 \frac{(\epsilon_{eff} + 0.300) \left( \frac{W}{H} + 0.262 \right)}{(\epsilon_{eff} - 0.258) \left( \frac{W}{H} + 0.813 \right)} \quad (3)$$

By using above equation we can find the value of actual length of the patch as,

$$L = \frac{c}{2f\sqrt{\epsilon_{eff}}} - 2\Delta L \quad (4)$$

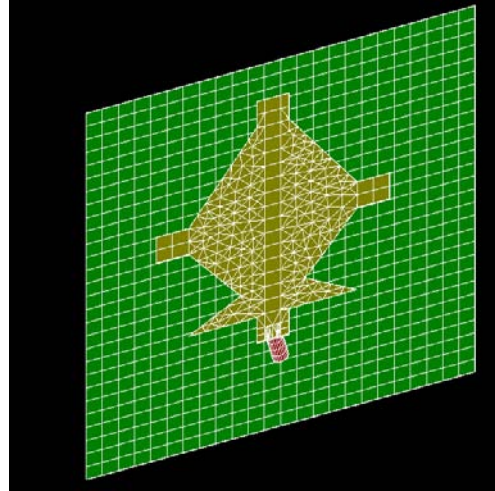
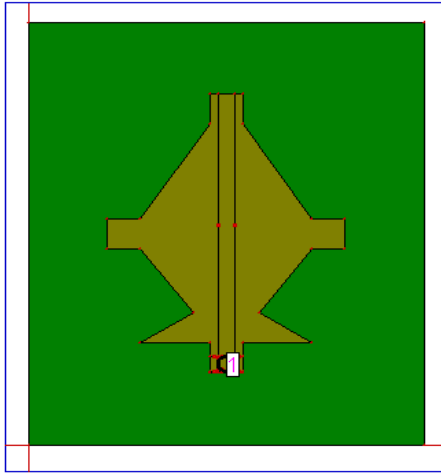

Figure 1 : Top view of the microstrip patch antenna

### III. SIMULATED RESULTS

In this section various parametric analysis of the proposed antenna are done and presented. Parameter of the antenna has been investigated to improve

bandwidth, gain and return loss performance of the antenna. The return loss plot of structure with probe of different radius is shown in fig 2 (a, b, c)

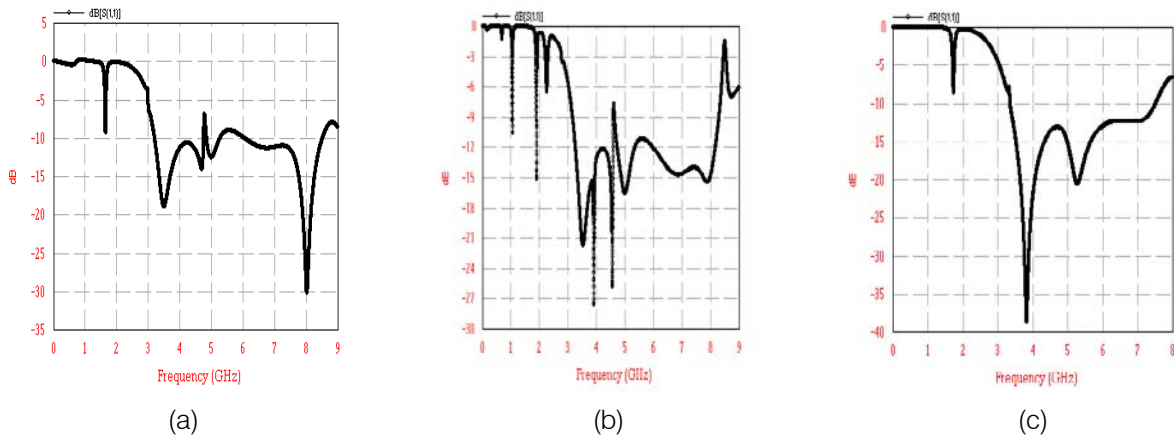

Figure 2 : Return loss plot of the microstrip patch antenna with probe of different radius (a).5mm (b) 0.4mm (c) 0.16mm

In proposed antenna the return loss is -18dB at 3.5 GHz and -30 dB at 8GHz. While the frequencies range of band below -10 dB and VSWR < 2 is 3.208 GHz - 4.763 GHz, 4.853 GHz - 5.293 GHz and 6.029 GHz-8.533 GHz shown in fig 2(a). We can see that there is no resonant frequency at 3.9GHz and 4.5 GHz in fig 2 (a) while in fig 2 (b) return loss at 3.9 GHz Frequency is around 28 dB and at 4.5GHz it is 26 dB, at 3.5 GHz we

get the return loss of around 22 dB. The frequency range we are getting below 10 dB and VSWR < 2 is 1.899GHz – 1.912GHz, 3.189GHz – 4.601GHz and 4.655GHz – 8.29 GHz. In fig 2(c) the return loss at around 3.9 GHz is around 39 dB and band below 10 dB (VSWR < 2) is ranging from 3.362 GHz – 7.53GHz.

a) Effect of Parameter (radius  $r$  of probe) on Band of Proposed Design

If the radius of the probe is decreased from 0.5 mm to 0.4 mm dramatically changes will appear in the result. We can see the details given in table 1, we are getting three bands of frequency in first structure when radius is 0.5 mm but when we decrease the radius we get two band in which we get the bandwidth of 36.25% in first band and 56.16% in the second band the max.

Gain remains the same in band 1 as in the previous case but in band two the max. Gain is reduced by only 0.5 dBi. Max. Efficiency remains almost same and max. Directivity is around 6.5 dBi. Now if we further decrease the radius of probe from 0.4 mm to 0.16 mm (sl.no.3, fig.1) we achieve impedance bandwidth of 76.53 % which is almost double the frequency in the first stage when radius of the probe is 0.5 mm with max. Gain of 3.5 dBi, efficiency 90 % and max. Directivity of 5.5 dBi.

Table 1 : Parameters on probes of different radius

Serial No.	Radius of probe	Band of Freq. (in GHz)	%Bandwidth	Max. Gain	% Efficiency	Max. Directivity
1	0.5 mm	3.208 - 4.763 4.853 - 5.293 6.029 - 8.533	39.02 % 8.67 % 3.39 %	3.5 dBi 3.5 dBi 4.5 dBi	90% 65 % 65 %	6.75 dBi
2	0.4 mm	3.189 - 4.601 4.655 - 8.29	36.25 % 56.16 %	3.5 dBi 4.0 dBi	90 % 75 %	6.5 dBi
3	0.16 mm	3.362 - 7.53	76.53 %	3.5 dBi	90 %	5.5 dBi

Total gain versus frequency plot is shown in fig3. Max. Directivity versus frequency plot and efficiency versus frequency plot are shown in fig 4 and 5.

Radiation pattern plot, 2D Elevation Pattern Gain display plot and 2D azimuth pattern Gain display plot is shown in fig.6, 7 and 8 respectively.

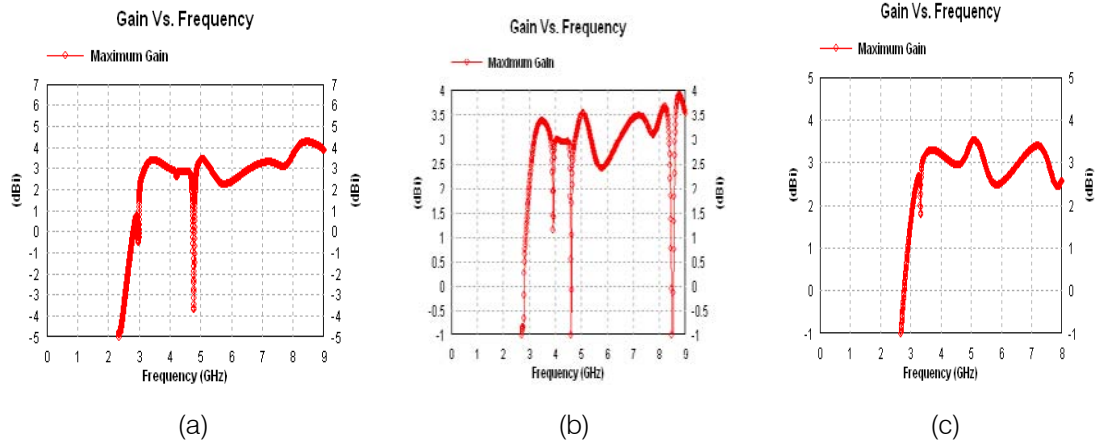

Figure 3 : Maximum gain plot of microstrip patch antenna for probe of radius (a) 0.5 mm (b) 0.4 mm (c) 0.16 mm

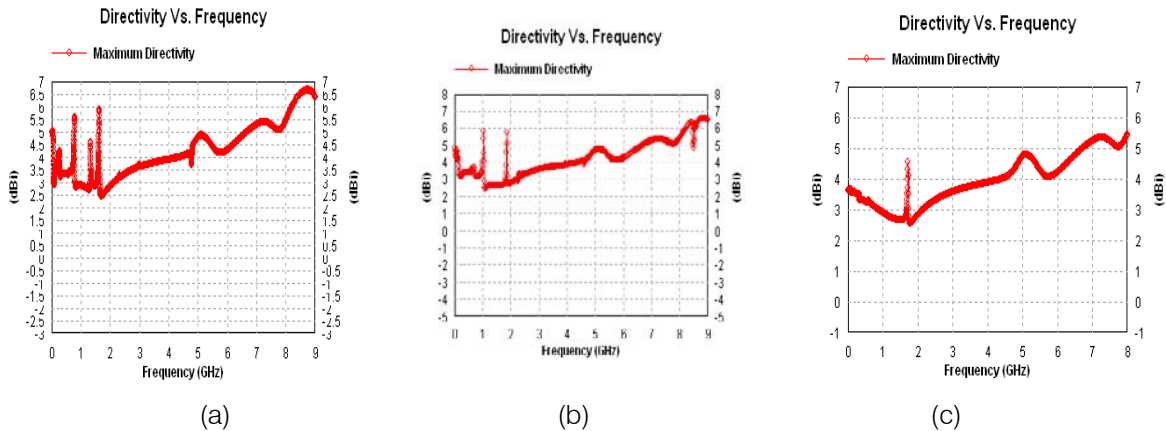

Figure 4 : Directivity versus frequency plot of microstrip patch antenna for probe of radius (a) 0.5 mm (b) 0.4 mm (c) 0.16 mm

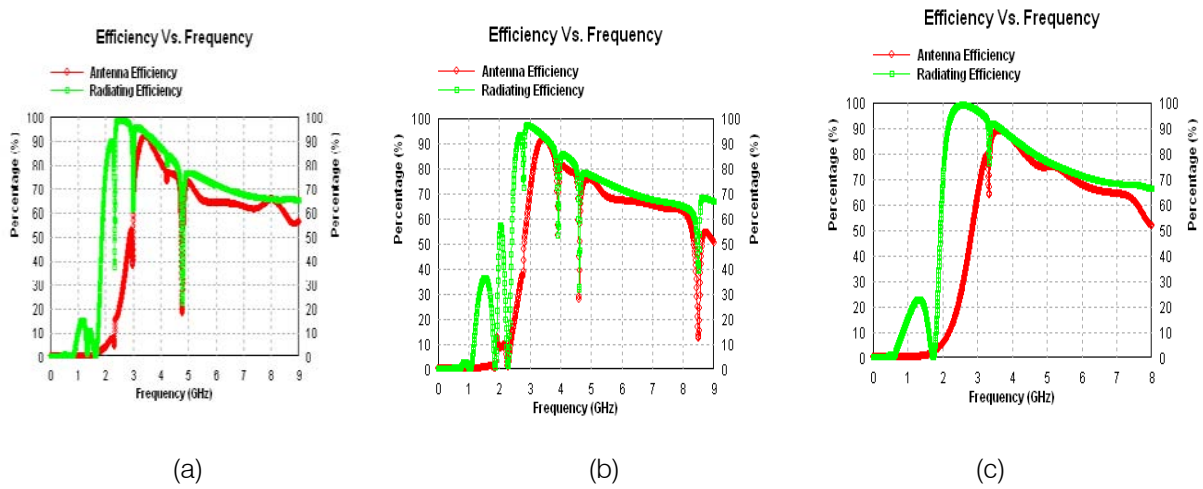

Figure 5 : Efficiency versus frequency plot of the microstrip patch antenna for probe of radius (a) 0.5 mm (b) 0.4 mm (c) 0.16 mm

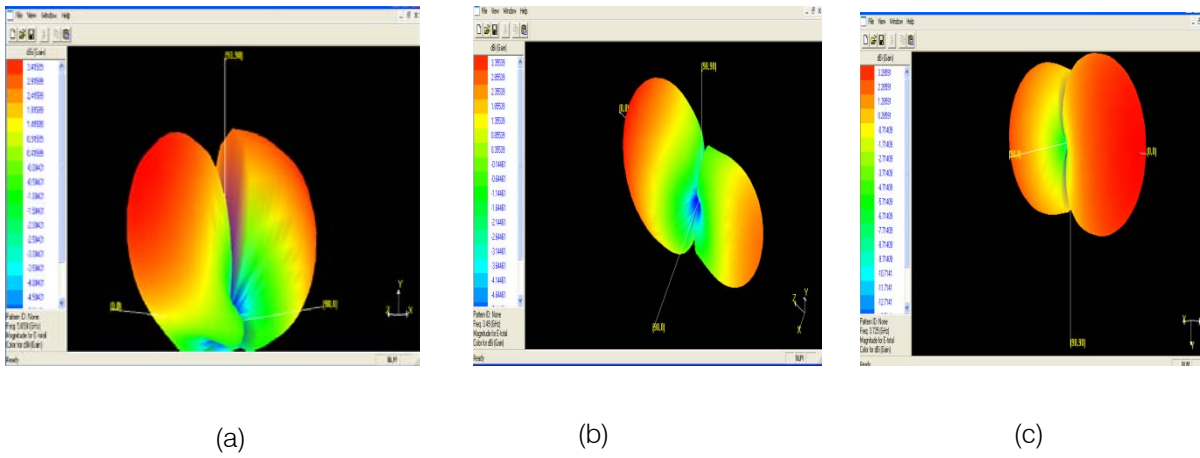

Figure 6 : 3D Radiation pattern plot of the microstrip patch antenna for probe of radius (a) 0.5 mm (b) 0.4 mm (c) 0.16 mm

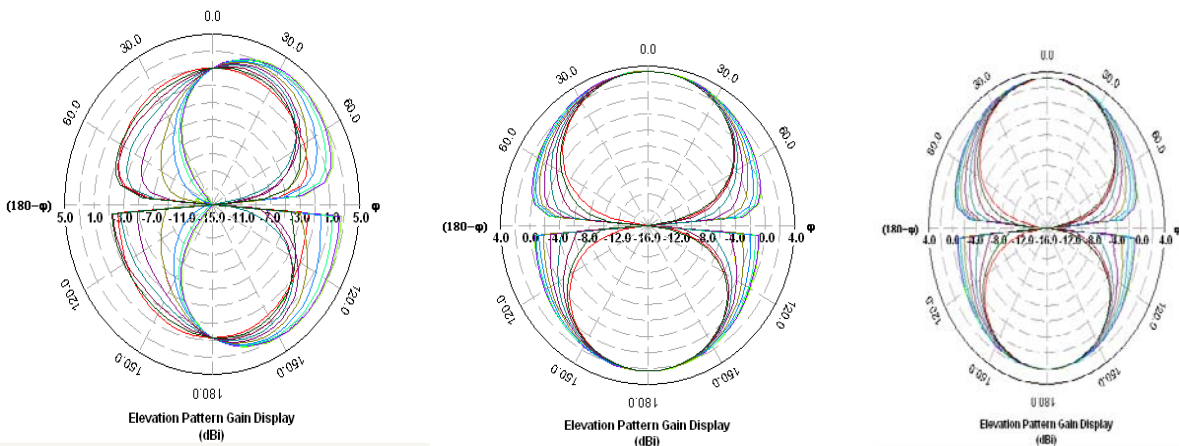

Figure 7 : 2D Elevation Pattern Gain Display (dBi) for probe of radius (a) 0.5 mm (b) 0.4 mm (c) 0.16 mm

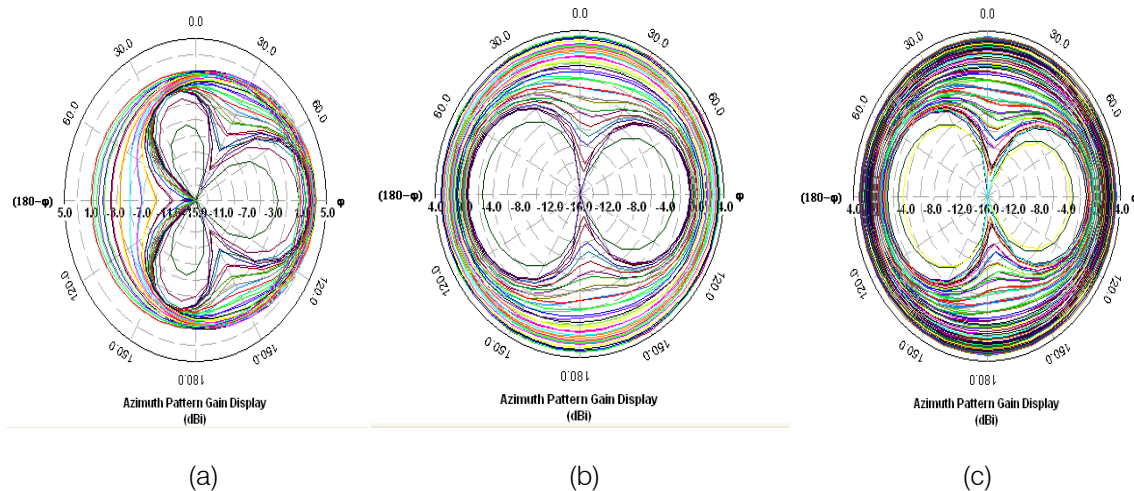

Figure 7 : 2D Azimuth Pattern Gain Display (dBi) for probe of radius (a) 0.5 mm (b) 0.4 mm (c) 0.16 mm

#### IV. CONCLUSION

In this paper a compact size microstrip antenna has been designed having good impedance matching as well as high antenna efficiency of about of about 90% is achieved by changing the radius of the probe. The impedance band width has been enhanced from 39 % to 76.53 %. The proposed antenna have larger impedance bandwidth of 76.53% covering the frequency range from 3.362 GHz -7.53 GHz which is suitable for WLAN (upper band application).

#### REFERENCES RÉFÉRENCES REFERENCIAS

1. M. Abbaspour and H. R. Hassani "Wideband star-shaped microstrip patch antenna" Progress In Electromagnetics Research Letters, Vol. 1, 61–68, 2008.
2. W. Ren "Compact dual-band slot antenna for 2.4/5ghz wlan applications" Progress In Electromagnetics Research B, Vol. 8, 319–327, 2008.
3. M. T. Islam, M. N. Shakib and N. Misran "Design analysis of high gain wideband L-probe fed microstrip patch antenna" Progress In Electromagnetics Research, PIER 95, 397-407, 2009.
4. S. Maci and G. Bifji Gentili "Dual-Frequency Patch Antennas" IEEE Antennas and Propagation Magazine, Vol. 39, No. 6, December 1997.
5. ZAAKRI Safa, ZENKOUAR Lahbib "Conception of Bi-band Rectangular Microstrip Array Antenna" Journal of Microwaves, Optoelectronics and Electromagnetic Applications, Vol. 12, No. 1, June 2013.
6. Xiaofei Shi, Zhihong Wang, Hua Su, Yun Zhao, "A H-type Microstrip Slot Antenna in Ku-band Using LTCC Technology with Multiple Layer Substrates," Proc. IEEE, Vol. 978-1, pp. 7104 - 7106, 2011.
7. U. Chakraborty, S. Chatterjee, S. K. Chowdhury, P. P. Sarkar "A compact microstrip patch antenna for wireless communication" Progress In Electromagnetics Research C, Vol. 18, 211-220, 2011.
8. H. Sabri and Z. Atlasbaf "Two novel compact triple band microstrip annular-ring slot antenna for PCS-1900 and WLAN applications." Progress In Electromagnetics Research Letters, Vol. 5, 87–98, 2008.
9. Ramadan, A., K. Y. Kaban, A. El-Hajj, S. Khoury, and M. Al-usseini, "A reconfigurable U-Koch microstrip antenna for wireless applications," Progress In Electromagnetics Research, PIER 93, 355-367, 2009.
10. Kawei Qian and Xiaohong Tang, "Compact LTCC dual-band circularly polarized perturbed hexagonal microstrip antenna," IEEE Antennas and Wireless Propagation Letters, Vol. 10 pp. 1212-1215, 2011.
11. K. Kumar and N. Gunasekaran, "A novel wideband slotted mm wave microstrip patch antenna," Proc. IEEE Vol. 987-1. pp. 10-14, 2011.
12. D. Xi, L. H. Wen, Y. Z. Yin, Z. Zhang, and Y. N. Mo "A Compact dual inverted C Shaped slots antenna for WLAN application" Progress In Electromagnetics Research Letters, Vol. 17, 115-123, 2010.
13. M. T. Islam, M. N. Shakib and N. Misran, "Broadband E-H shaped microstrip patch antenna for wireless systems," Progress In Electromagnetics Research, PIER 98, 163-173, 2009.
14. Kasabegoudar, V. G. and K. J. Vinoy, "A broadband suspended microstrip antenna for circular polarization," Progress In Electromagnetics Research, PIER 90, 353-368, 2009.
15. Alloyed, M. N. Kamjani, and M. Shobeyri, "A novel cross-slot geometry to improve impedance bandwidth of microstrip antennas," Progress In Electromagnetics Research Letters, Vol. 4, 63-72, 2008.

16. G. M. Zhang, J. S. Hong and B. Z. Wang, "Two novel band-notched UWB slot antennas fed by microstrip line," Progress In Electromagnetics Research, PIER 78, 209-218, 2008.
17. Yu, A. and X. X. Zhang, "A method to enhance the bandwidth of microstrip antennas using a modified E-shaped patch," Proceedings of Radio and Wireless Conference, 261-264, Aug. 10-13, 2003.
18. D. M. Pozar, "Microstrip Antennas," Proc. IEEE, vol. 80, No. 1, pp. 79-81, January 1992.
19. Ram Singh Kushwaha, D.K.Srivastava, J.P.Saini "Compact Triple Band Slotted Microstrip Patch Antenna" International Journal of Engineering Science and Technology (IJEST), Vol. 4 No.03, March 2012.
20. K.Shambavi, "Gain and Bandwidth Enhancement Technique in Square Microstrip Antenna for WLAN application", Asia-Pacific Microwave Conference 2007, pp.4284-4287.
21. C.A. Balanis, "Antenna theory", John Wiley, 1982, pp 727-734.
22. Bahl, I.J. and Bharatia, P. "Microstrip Antennas", Artech House, 1980.
23. Girish Kumar & K.P.Ray "Broad Band Microstrip Antenna", Artech House, USA, 2003, Chapter 1, pp.1-21.



GLOBAL JOURNAL OF RESEARCHES IN ENGINEERING  
ELECTRICAL AND ELECTRONICS ENGINEERING  
Volume 13 Issue 17 Version 1.0 Year 2013  
Type: Double Blind Peer Reviewed International Research Journal  
Publisher: Global Journals Inc. (USA)  
Online ISSN: 2249-4596 & Print ISSN: 0975-5861

## Comparative Study on DC Motor Speed Control using Various Controllers

By K. Venkateswarlu & Dr. Ch. Chengaiah

*Sri Venkateswara University, India*

*Abstract-* Electrical machines like DC motors, brushless DC motors, permanent magnet DC motors are being controlled with power electronics converters. The control has become precise with invention of Micro Controllers and power devices like IGBT, Power MOSFET. In this paper the attempt is made to simulate a speed control of separately excited DC motor with PID and fuzzy controllers. The aim of development of this paper is towards providing efficient method to control speed of DC motor using analog Controller. With the availability of MATLAB/SIMULINK, Fuzzy Controller for comprehensive study of modeling analysis and speed control design methods has been demonstrated.

*Keywords:* DC motor, open loop, closed loop system, speed control, PID controller and fuzzy controller.

*GJRE-F Classification : FOR Code: 090699*



*Strictly as per the compliance and regulations of :*



# Comparative Study on DC Motor Speed Control using Various Controllers

K. Venkateswarlu<sup>α</sup> & Dr. Ch. Chengaiah<sup>ο</sup>

**Abstract-** Electrical machines like DC motors, brushless DC motors, permanent magnet DC motors are being controlled with power electronics converters. The control has become precise with invention of Micro Controllers and power devices like IGBT, Power MOSFET. In this paper the attempt is made to simulate a speed control of separately excited DC motor with PID and fuzzy controllers. The aim of development of this paper is towards providing efficient method to control speed of DC motor using analog Controller. With the availability of MATLAB/SIMULINK, Fuzzy Controller for comprehensive study of modeling analysis and speed control design methods has been demonstrated.

**Keywords:** DC motor, open loop, closed loop system, speed control, PID controller and fuzzy controller.

## I. INTRODUCTION

The field of electrical energy will be divided into three areas: Electronics, Power and Control. Electronics basically deals with the study of semiconductor devices and circuits at lower power. Power involves generation, transmission and distribution of electrical energy. Modern manufacturing systems are automated machines that perform the required tasks. The electric motors are perhaps the most widely used energy converters in the modern machine tools and robots. These motors require automatic control of their main parameters such as speed, position, acceleration etc...

In this paper separately excited DC drive system is used, because of their simplicity, ease of applications such as reliability and favorable cost have long been a backbone of industrial applications and it will have a long tradition of use as adjustable speed machines and a wide range of options have evolved for this purpose. In these applications, the motor should be precisely controlled to give the desired performance.

Many varieties of control schemes such as proportional, integral, derivative, proportional integral (PI), PID, adaptive, and FLCs, have been developed for speed control of dc motors. The important aspect of the speed control of a dc motor is the armature voltage control method. By varying voltage to the armature of a dc motor, the speed of the motor can be varied. Speed of a DC motor can be controlled by PID controller also.

In this paper mainly concentrated on speed control of separately excited DC motor. the design of a

mathematical model of the separately excited DC motor using MATLAB code has been done and SIMULINK model is used for studying the performance characteristics of dc motor and mainly concentrated on the design of PID controller and Fuzzy logic controller using MATLAB/ SIMULINK model.

## II. MATHEMATICAL MODELING OF SEPARATELY EXCITED DC MOTOR

In order to build the DC motor's transfer function, its simplified mathematical model has been used. This model consists of differential equations for the electrical part, mechanical part and the interconnection between them. The electric circuit of the armature and the free body diagram of the rotor is shown in the Fig 1. and the physical parameters of the motor is shown in table1.

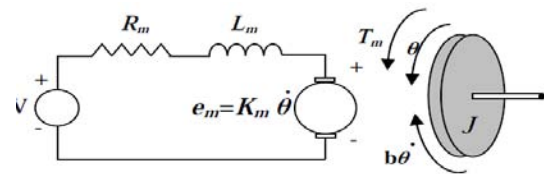

Figure 1 : The electric circuit of the armature and the free body diagram of the rotor for a DC motor

Table 1 : Physical parameters of the DC motor

$J$	Moment of Inertia of the Rotor(kg.m <sup>2</sup> )	0.01
$b$	Damping ratio of the Mechanical System (Nms)	0.1
$K_m$	Motor Constant (Nm/A)	0.01
$R_m$	Motor Electric Resistance( $\Omega$ )	1
$L_m$	Motor Electric Inductance(H)	0.5
$V$	Input Voltage(Volt)	6
$\omega$	Rotating Speed(r/s)	600

The motor torque,  $T_m$ , is related to the armature current ( $I$ ), by a constant factor  $K_t$ . The back emf ( $e_m$ ) is related to the rotational speed by the following equations.

Author  $\alpha$ : PG Student SVUCE.

e-mail: k.venkateswarlu256@gmail.com

Author  $\sigma$ : Associate Professor SVUCE.



$$T_m = K_t I \tag{1}$$

$$e_m = K_e \dot{\theta} \tag{2}$$

Assuming that,  $K_t$ (torque constant) =  $K_e$ (electromotive force constant) =  $K_m$  (motor constant).

From Fig.1 and physical parameters of system mentioned above, the following equations can be written based on Newton's law combined with Kirchhoff's laws.

$$J\ddot{\theta} + b\dot{\theta} = K_m i - T_L \tag{3}$$

$$L_m \frac{di}{dt} + R_m i = V - K_m \dot{\theta} \tag{4}$$

*Transfer Function Model of DC Motor*

Using Laplace Transforms, the above equations can be expressed in terms of s-domain

$$s(Js + b)\dot{\theta}(s) = K_m I(s) - T_L(s) \tag{5}$$

$$(L_m(s) + R_m)I(s) = V(s) - K_m s\theta(s) \tag{6}$$

By eliminating  $I(s)$ , the following open-loop transfer function can be obtained, where the rotational speed is the output and the voltage  $V$  is the input. When the motor is used as a component in a system, it is desired to describe it by the appropriate transfer function between the motor voltage and its speed. For this purpose assuming (load torque)  $T_L = 0$  and (friction torque)  $T_F = 0$ , since neither affects the transfer function.

$$\left. \frac{\dot{\theta}(s)}{V(s)} \right|_{T_L(s)=0} = \frac{K_m}{(Js + b)(L_m s + R_m) + K_m^2} \tag{7}$$

III. PID CONTROLLER

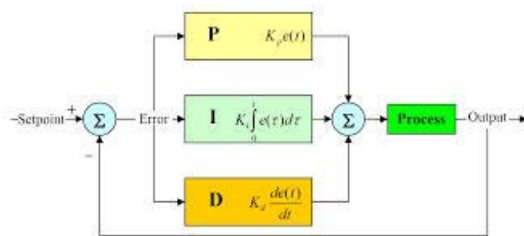

Figure 2 : PID Implementation

The PID control is most widely used in industrial applications. PID controller is implemented to control the speed of DC motor. The implementation of a PID controller is shown in fig (2). The error between the reference speed and the actual speed is given as input to a PID controller. The PID controller depending on the error changes its output, to control the process input such that the error is minimized. A detailed information about the theory and tuning of PID controllers is given in [1]. The Transfer function of a PID controller is given as,

$$c(s) = K_p \left( 1 + \frac{1}{T_I * s} + T_D * s \right) \tag{8}$$

The proportional control ( $K_p$ ) is used so that the control signal  $u(t)$  responds to the error immediately. But the error is never reduced to zero and an offset error is inherently present. To remove the offset error the Integral control action ( $T_I$ ) is used. To Derivative control ( $T_D$ ) is used to damped out oscillations in the process response. Also, the presence of derivative control reduces the need of  $K_p$  being large to achieve stability.

By tuning the gains of the PID controller and producing the optimum response using trial and error method. With the help of MATLAB programming, the performance of separately excited DC motor with and without PID controller was obtained and results are tabulated in table2.

Table 2 : PID controller responses

response	Open loop (sec)	Closed loop (sec)	with PID controller (sec)
Rise Time	1.1362	1.0173	0.1195
Settling Time	2.0653	1.8476	16.0587
Settling Min	0.0901	0.0825	0.8841
Settling Max	0.0999	0.0908	1.0878
Overshoot	0	0	8.7813
Undershoot	0	0	0
Peak	0.0999	0.0908	1.0878
Peak Time	5.2388	4.6398	0.2337

Here a clear cut comparison is given for various values like rise time, dead time etc... in table 2. By employing this PID controller it can be seen that drastically reduced from 1.1362 in open loop to 0.1195 in closed loop system. Coming to peak time there is significant change from open loop to PID controlled system i.e. from 5.2388 seconds to 0.2337 but coming to settling time there is a drastic change from 2.0653 to 16.0857, this is not desirable. There is change in dead time i.e. improvement in dead time from 4 sec to 1 seconds in this system.

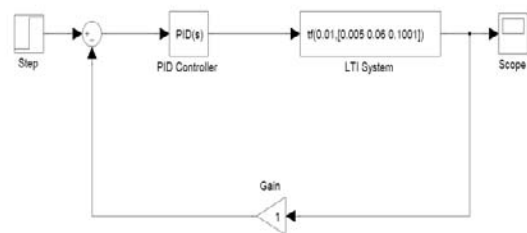

Figure 3 : Simulink model of PID controller

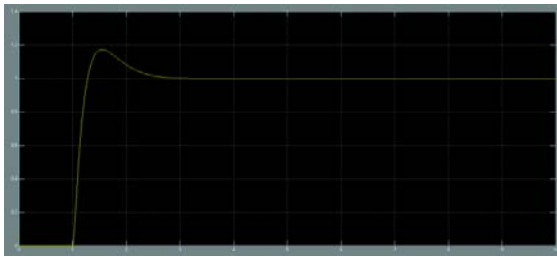

Figure 4 : Response of PID controller

IV. FUZZY CONTROLLER

Fuzzy logic control (FLC) is a control algorithm based on a linguistic control strategy which tries to account the human’s knowledge about how to control a system without requiring a mathematical model. The approach of the basic structure of the fuzzy logic controller system is illustrated in Fig 5.

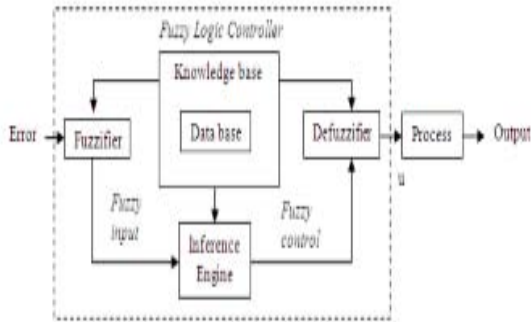

Figure 5 : Structure of Fuzzy Logic Controller

Basically, the Fuzzy Logic controller consists of four basic components: fuzzification, a knowledge base, inference engine, and a defuzzification interface. Each component affects the effectiveness of the fuzzy controller and the behavior of the controlled system. In the fuzzification interface, a measurement of inputs and a transformation, which converts input data into suitable linguistic variables, are performed which mimic human decision making. The results obtained by fuzzy logic depend on fuzzy inference rules and fuzzy implication operators. The knowledge base provides necessary information for linguistic control rules and the information for fuzzification and defuzzification. In the defuzzification interface, an actual control action is obtained from the results of fuzzy inference engine.

Input and outputs are non-fuzzy values and the basic configuration of FLC is featured in Fig6. In the system presented in this study, Mamdani type of fuzzy logic is used for speed controller. Inputs for Fuzzy Logic controller are the speed error (e) and change of speed error. Speed error is calculated with comparison between reference speed,  $\omega_{ref}$  and the actual speed,  $\omega_{act}$ .

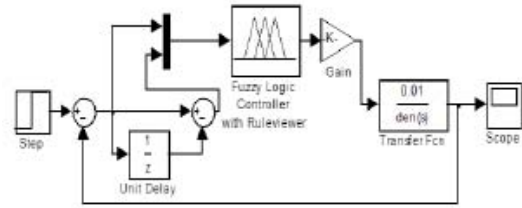

Figure 6 : Simulink model for FUZZY controller

Fuzzy Rule Matrix

The control rules that relate the fuzzy output to the fuzzy inputs which are derived from general knowledge of the system behavior is shown in table 3. Some of the control rules are developed using trial and error method.

Table 3 : Rule Matrix Table

de \ e	NB	N	Z	P	PB
NB	NVB	NB	N	NS	Z
N	NB	N	NS	Z	PS
Z	N	NS	Z	PS	P
P	NS	Z	PS	P	PB
PB	Z	PS	P	PB	PVB

To illustrate the control of motor by the fuzzy rule matrix, 5 valid rules from the rule matrix table are identified for Zero & Positive small of error and change in error.

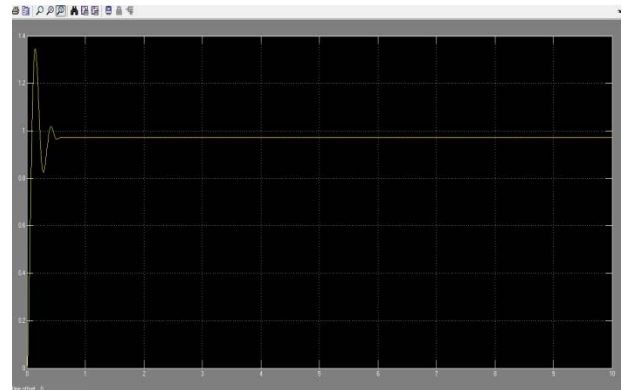

Figure 7 : Response with FUZZY controller

Table 4 : Comparison of results

Open Loop (sec)	Closed Loop(sec)	PID (sec)	FUZZY (sec)
Rise Time: 1.1362	Rise Time: 1.017	Rise time: 0.1195	Rise time: 0.2
Settling Time: 2.0653	Settling Time:1.847	Settling time: 16.0587	Settling time: 0.6
Peak: 0.0999	Peak: 0.090	Dead time: 1	Dead time: 0
Peak Time: 5.2388	PeakTime: 4.6398		

All these shows a great change in the performance of the system. However there is peak overshoot and steady state error .This steady state error can be removed by increasing the gain and peak overshoot automatically will reduce as load is employed on the system. Hence these will not pose any problem on system performance. The above Simulink results are tabulated in Table 4.

From fig7 there is no dead time in the system i.e. dead time is 0. Hence we have reached one of our aim .there is a considerable decrease in rise time which is in the order of 0.2sec. This shows how fastly the system is responding. system has reached its steady state before 0.6 seconds, all these shows a great change in the performance of the system.

## V. CONCLUSIONS

Speed response characteristics of separately excited dc motor were obtained by mathematical model using MATLAB coding and SIMULINK model. The response is found to be not satisfactory i.e. response doesn't satisfy the desired design requirements like rise time, settling time, peak value, steady state error and dead time etc. There exists a dead time of 1 sec which is a major drawback to the system by conventional method.

To overcome the above drawback we employed PID controller design, by proper tuning of  $K_p$ ,  $K_i$  and  $K_d$  to improved the characteristics like steady state error. But the above designed system failed to reduce the dead time of the system. Hence in order to reduce the dead time modern technique like FUZZY controller was employed.

FUZZY controller is proposed to replace conventional PID controller to improve the system characteristics. The corresponding step response is very smooth and ripples free. The rule base adopted is of MAMDANI type and its rule viewer is presented.

## REFERENCES RÉFÉRENCES REFERENCIAS

1. Dr. Jamal A. Mohammed, Modeling, Analysis and Speed Control Design Methods of a DC Motor ,Eng. & Tech. Journal ,vol .29, no.1,2011
2. I.J.Nagrath and M.Gopal, Control Systems Engineering, (Wiley Eastern Limited).
3. S. Ayasun and C. O. Nwankpa, DC Motor Speed Control Methods Using MATLAB/Simulink and Their Integration into Undergraoutputate Electric Machinery Courses, IEEE Trans Eoutputc, March, (2007), 347-354.
4. S. Othman, "Proportional Integral and Derivative Control of Brushless DC Motor," European Journal of Scientific Research, Vol. 35 No. 2 (2009), pp. 198-203.
5. Allaoua, B. Gasbaoui and B. Mebarki, "Setting Up PID DC Motor Speed Control Alteration Parameters Using Particle Swarm Optimization Strategy", Leonardo Electronic Journal of Practices and Technologies, Issue 14, Jan.-June 2009, pp. 19-32.
6. M. H. Rashid, Power Electronics, Circuits Devices and Applications, 2nd Edition, Prentice- Hall International, Inc., New Jersey, 1993.
7. W. P. Aung," Analysis on Modeling and Simulink of DC Motor and its Driving System Used for Wheeled Mobile Robot", World Academy of Science, Engineering and Technology 32, 2007, pp.299- 306.
8. B. Kuo, Automatic Control Systems, Prentice-Hall, Englewood, Cliffs.NJ, 1995.
9. N. S. Nise, Control Systems Engineering (3 rd Edition), John Wiley and Sons Inc., New York, 2000.
10. A. Klee, Development of a Motor Speed Control System Using MATLAB and Simulink, Implemented with a Digital Signal Processor, MSc. Thesis, Orlando, Florida, 2005.

# GLOBAL JOURNALS INC. (US) GUIDELINES HANDBOOK 2013

---

[WWW.GLOBALJOURNALS.ORG](http://WWW.GLOBALJOURNALS.ORG)

# FELLOWS

## FELLOW OF ASSOCIATION OF RESEARCH SOCIETY IN ENGINEERING (FARSE)

Global Journals Incorporate (USA) is accredited by Open Association of Research Society (OARS), U.S.A and in turn, awards “FARSE ” title to individuals. The 'FARSE' title is accorded to a selected professional after the approval of the Editor-in-Chief /Editorial Board Members/Dean.



- The “FARSE” is a dignified title which is accorded to a person’s name viz. Dr. John E. Hall, Ph.D., FARSE or William Walldroff, M.S., FARSE.

FARSE accrediting is an honor. It authenticates your research activities. After recognition as FARSE, you can add 'FARSE' title with your name as you use this recognition as additional suffix to your status. This will definitely enhance and add more value and repute to your name. You may use it on your professional Counseling Materials such as CV, Resume, and Visiting Card etc.

*The following benefits can be availed by you only for next three years from the date of certification:*



FARSE designated members are entitled to avail a 40% discount while publishing their research papers (of a single author) with Global Journals Incorporation (USA), if the same is accepted by Editorial Board/Peer Reviewers. If you are a main author or co-author in case of multiple authors, you will be entitled to avail discount of 10%.

Once FARSE title is accorded, the Fellow is authorized to organize a symposium/seminar/conference on behalf of Global Journal Incorporation (USA).The Fellow can also participate in conference/seminar/symposium organized by another institution as representative of Global Journal. In both the cases, it is mandatory for him to discuss with us and obtain our consent.



You may join as member of the Editorial Board of Global Journals Incorporation (USA) after successful completion of three years as Fellow and as Peer Reviewer. In addition, it is also desirable that you should organize seminar/symposium/conference at least once.

We shall provide you intimation regarding launching of e-version of journal of your stream time to time.This may be utilized in your library for the enrichment of knowledge of your students as well as it can also be helpful for the concerned faculty members.





The FARSE can go through standards of OARS. You can also play vital role if you have any suggestions so that proper amendment can take place to improve the same for the benefit of entire research community.

As FARSE, you will be given a renowned, secure and free professional email address with 100 GB of space e.g. johnhall@globaljournals.org. This will include Webmail, Spam Assassin, Email Forwarders, Auto-Responders, Email Delivery Route tracing, etc.

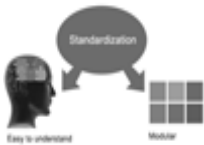

The FARSE will be eligible for a free application of standardization of their researches. Standardization of research will be subject to acceptability within stipulated norms as the next step after publishing in a journal. We shall depute a team of specialized research professionals who will render their services for elevating your researches to next higher level, which is worldwide open standardization.

The FARSE member can apply for grading and certification of standards of their educational and Institutional Degrees to Open Association of Research, Society U.S.A. Once you are designated as FARSE, you may send us a scanned copy of all of your credentials. OARS will verify, grade and certify them. This will be based on your academic records, quality of research papers published by you, and some more criteria. After certification of all your credentials by OARS, they will be published on your Fellow Profile link on website <https://associationofresearch.org> which will be helpful to upgrade the dignity.



The FARSE members can avail the benefits of free research podcasting in Global Research Radio with their research documents. After publishing the work, (including published elsewhere worldwide with proper authorization) you can upload your research paper with your recorded voice or you can utilize chargeable services of our professional RJs to record your paper in their voice on request.

The FARSE member also entitled to get the benefits of free research podcasting of their research documents through video clips. We can also streamline your conference videos and display your slides/ online slides and online research video clips at reasonable charges, on request.





The FARSE is eligible to earn from sales proceeds of his/her researches/reference/review Books or literature, while publishing with Global Journals. The FARSE can decide whether he/she would like to publish his/her research in a closed manner. In this case, whenever readers purchase that individual research paper for reading, maximum 60% of its profit earned as royalty by Global Journals, will be credited to his/her bank account. The entire entitled amount will be credited to his/her bank account exceeding limit of minimum fixed balance. There is no minimum time limit for collection. The FARSE member can decide its price and we can help in making the right decision.

The FARSE member is eligible to join as a paid peer reviewer at Global Journals Incorporation (USA) and can get remuneration of 15% of author fees, taken from the author of a respective paper. After reviewing 5 or more papers you can request to transfer the amount to your bank account.



## MEMBER OF ASSOCIATION OF RESEARCH SOCIETY IN ENGINEERING (MARSE)

The 'MARSE ' title is accorded to a selected professional after the approval of the Editor-in-Chief / Editorial Board Members/Dean.

The “MARSE” is a dignified ornament which is accorded to a person’s name viz. Dr. John E. Hall, Ph.D., MARSE or William Walldroff, M.S., MARSE.



MARSE accrediting is an honor. It authenticates your research activities. After becoming MARSE, you can add 'MARSE' title with your name as you use this recognition as additional suffix to your status. This will definitely enhance and add more value and repute to your name. You may use it on your professional Counseling Materials such as CV, Resume, Visiting Card and Name Plate etc.

*The following benefits can be availed by you only for next three years from the date of certification.*



MARSE designated members are entitled to avail a 25% discount while publishing their research papers (of a single author) in Global Journals Inc., if the same is accepted by our Editorial Board and Peer Reviewers. If you are a main author or co-author of a group of authors, you will get discount of 10%.

As MARSE, you will be given a renowned, secure and free professional email address with 30 GB of space e.g. johnhall@globaljournals.org. This will include Webmail, Spam Assassin, Email Forwarders, Auto-Responders, Email Delivery Route tracing, etc.





We shall provide you intimation regarding launching of e-version of journal of your stream time to time. This may be utilized in your library for the enrichment of knowledge of your students as well as it can also be helpful for the concerned faculty members.

The MARSE member can apply for approval, grading and certification of standards of their educational and Institutional Degrees to Open Association of Research, Society U.S.A.



Once you are designated as MARSE, you may send us a scanned copy of all of your credentials. OARS will verify, grade and certify them. This will be based on your academic records, quality of research papers published by you, and some more criteria.

It is mandatory to read all terms and conditions carefully.





## AUXILIARY MEMBERSHIPS

### Institutional Fellow of Open Association of Research Society (USA)-OARS (USA)

Global Journals Incorporation (USA) is accredited by Open Association of Research Society, U.S.A (OARS) and in turn, affiliates research institutions as “Institutional Fellow of Open Association of Research Society” (IFOARS).

The “FARSC” is a dignified title which is accorded to a person’s name viz. Dr. John E. Hall, Ph.D., FARSC or William Walldroff, M.S., FARSC.



The IFOARS institution is entitled to form a Board comprised of one Chairperson and three to five board members preferably from different streams. The Board will be recognized as “Institutional Board of Open Association of Research Society”-(IBOARS).

*The Institute will be entitled to following benefits:*



The IBOARS can initially review research papers of their institute and recommend them to publish with respective journal of Global Journals. It can also review the papers of other institutions after obtaining our consent. The second review will be done by peer reviewer of Global Journals Incorporation (USA) The Board is at liberty to appoint a peer reviewer with the approval of chairperson after consulting us.

The author fees of such paper may be waived off up to 40%.

The Global Journals Incorporation (USA) at its discretion can also refer double blind peer reviewed paper at their end to the board for the verification and to get recommendation for final stage of acceptance of publication.



The IBOARS can organize symposium/seminar/conference in their country on behalf of Global Journals Incorporation (USA)-OARS (USA). The terms and conditions can be discussed separately.

The Board can also play vital role by exploring and giving valuable suggestions regarding the Standards of “Open Association of Research Society, U.S.A (OARS)” so that proper amendment can take place for the benefit of entire research community. We shall provide details of particular standard only on receipt of request from the Board.



Journals Research  
inducing researches

The board members can also join us as Individual Fellow with 40% discount on total fees applicable to Individual Fellow. They will be entitled to avail all the benefits as declared. Please visit Individual Fellow-sub menu of GlobalJournals.org to have more relevant details.



We shall provide you intimation regarding launching of e-version of journal of your stream time to time. This may be utilized in your library for the enrichment of knowledge of your students as well as it can also be helpful for the concerned faculty members.



After nomination of your institution as “Institutional Fellow” and constantly functioning successfully for one year, we can consider giving recognition to your institute to function as Regional/Zonal office on our behalf. The board can also take up the additional allied activities for betterment after our consultation.

**The following entitlements are applicable to individual Fellows:**

Open Association of Research Society, U.S.A (OARS) By-laws states that an individual Fellow may use the designations as applicable, or the corresponding initials. The Credentials of individual Fellow and Associate designations signify that the individual has gained knowledge of the fundamental concepts. One is magnanimous and proficient in an expertise course covering the professional code of conduct, and follows recognized standards of practice.



Open Association of Research Society (US)/ Global Journals Incorporation (USA), as described in Corporate Statements, are educational, research publishing and professional membership organizations. Achieving our individual Fellow or Associate status is based mainly on meeting stated educational research requirements.

Disbursement of 40% Royalty earned through Global Journals : Researcher = 50%, Peer Reviewer = 37.50%, Institution = 12.50% E.g. Out of 40%, the 20% benefit should be passed on to researcher, 15 % benefit towards remuneration should be given to a reviewer and remaining 5% is to be retained by the institution.



We shall provide print version of 12 issues of any three journals [as per your requirement] out of our 38 journals worth \$ 2376 USD.

**Other:**

**The individual Fellow and Associate designations accredited by Open Association of Research Society (US) credentials signify guarantees following achievements:**

- The professional accredited with Fellow honor, is entitled to various benefits viz. name, fame, honor, regular flow of income, secured bright future, social status etc.



- In addition to above, if one is single author, then entitled to 40% discount on publishing research paper and can get 10% discount if one is co-author or main author among group of authors.
- The Fellow can organize symposium/seminar/conference on behalf of Global Journals Incorporation (USA) and he/she can also attend the same organized by other institutes on behalf of Global Journals.
- The Fellow can become member of Editorial Board Member after completing 3yrs.
- The Fellow can earn 60% of sales proceeds from the sale of reference/review books/literature/publishing of research paper.
- Fellow can also join as paid peer reviewer and earn 15% remuneration of author charges and can also get an opportunity to join as member of the Editorial Board of Global Journals Incorporation (USA)
- • This individual has learned the basic methods of applying those concepts and techniques to common challenging situations. This individual has further demonstrated an in-depth understanding of the application of suitable techniques to a particular area of research practice.

### Note :

//

- In future, if the board feels the necessity to change any board member, the same can be done with the consent of the chairperson along with anyone board member without our approval.
- In case, the chairperson needs to be replaced then consent of 2/3rd board members are required and they are also required to jointly pass the resolution copy of which should be sent to us. In such case, it will be compulsory to obtain our approval before replacement.
- In case of “Difference of Opinion [if any]” among the Board members, our decision will be final and binding to everyone.

//



## PROCESS OF SUBMISSION OF RESEARCH PAPER

---

The Area or field of specialization may or may not be of any category as mentioned in 'Scope of Journal' menu of the GlobalJournals.org website. There are 37 Research Journal categorized with Six parental Journals GJCST, GJMR, GJRE, GJMBR, GJSFR, GJHSS. For Authors should prefer the mentioned categories. There are three widely used systems UDC, DDC and LCC. The details are available as 'Knowledge Abstract' at Home page. The major advantage of this coding is that, the research work will be exposed to and shared with all over the world as we are being abstracted and indexed worldwide.

The paper should be in proper format. The format can be downloaded from first page of 'Author Guideline' Menu. The Author is expected to follow the general rules as mentioned in this menu. The paper should be written in MS-Word Format (\*.DOC,\*.DOCX).

The Author can submit the paper either online or offline. The authors should prefer online submission.Online Submission: There are three ways to submit your paper:

**(A) (I) First, register yourself using top right corner of Home page then Login. If you are already registered, then login using your username and password.**

**(II) Choose corresponding Journal.**

**(III) Click 'Submit Manuscript'. Fill required information and Upload the paper.**

**(B) If you are using Internet Explorer, then Direct Submission through Homepage is also available.**

**(C) If these two are not convenient, and then email the paper directly to dean@globaljournals.org.**

Offline Submission: Author can send the typed form of paper by Post. However, online submission should be preferred.

# PREFERRED AUTHOR GUIDELINES

## MANUSCRIPT STYLE INSTRUCTION (Must be strictly followed)

Page Size: 8.27" X 11"

- Left Margin: 0.65
- Right Margin: 0.65
- Top Margin: 0.75
- Bottom Margin: 0.75
- Font type of all text should be Swis 721 Lt BT.
- Paper Title should be of Font Size 24 with one Column section.
- Author Name in Font Size of 11 with one column as of Title.
- Abstract Font size of 9 Bold, "Abstract" word in Italic Bold.
- Main Text: Font size 10 with justified two columns section
- Two Column with Equal Column with of 3.38 and Gaping of .2
- First Character must be three lines Drop capped.
- Paragraph before Spacing of 1 pt and After of 0 pt.
- Line Spacing of 1 pt
- Large Images must be in One Column
- Numbering of First Main Headings (Heading 1) must be in Roman Letters, Capital Letter, and Font Size of 10.
- Numbering of Second Main Headings (Heading 2) must be in Alphabets, Italic, and Font Size of 10.

**You can use your own standard format also.**

### Author Guidelines:

1. General,
2. Ethical Guidelines,
3. Submission of Manuscripts,
4. Manuscript's Category,
5. Structure and Format of Manuscript,
6. After Acceptance.

### 1. GENERAL

Before submitting your research paper, one is advised to go through the details as mentioned in following heads. It will be beneficial, while peer reviewer justify your paper for publication.

### Scope

The Global Journals Inc. (US) welcome the submission of original paper, review paper, survey article relevant to the all the streams of Philosophy and knowledge. The Global Journals Inc. (US) is parental platform for Global Journal of Computer Science and Technology, Researches in Engineering, Medical Research, Science Frontier Research, Human Social Science, Management, and Business organization. The choice of specific field can be done otherwise as following in Abstracting and Indexing Page on this Website. As the all Global

Journals Inc. (US) are being abstracted and indexed (in process) by most of the reputed organizations. Topics of only narrow interest will not be accepted unless they have wider potential or consequences.

## 2. ETHICAL GUIDELINES

Authors should follow the ethical guidelines as mentioned below for publication of research paper and research activities.

Papers are accepted on strict understanding that the material in whole or in part has not been, nor is being, considered for publication elsewhere. If the paper once accepted by Global Journals Inc. (US) and Editorial Board, will become the copyright of the Global Journals Inc. (US).

**Authorship: The authors and coauthors should have active contribution to conception design, analysis and interpretation of findings. They should critically review the contents and drafting of the paper. All should approve the final version of the paper before submission**

The Global Journals Inc. (US) follows the definition of authorship set up by the Global Academy of Research and Development. According to the Global Academy of R&D authorship, criteria must be based on:

- 1) Substantial contributions to conception and acquisition of data, analysis and interpretation of the findings.
- 2) Drafting the paper and revising it critically regarding important academic content.
- 3) Final approval of the version of the paper to be published.

All authors should have been credited according to their appropriate contribution in research activity and preparing paper. Contributors who do not match the criteria as authors may be mentioned under Acknowledgement.

Acknowledgements: Contributors to the research other than authors credited should be mentioned under acknowledgement. The specifications of the source of funding for the research if appropriate can be included. Suppliers of resources may be mentioned along with address.

**Appeal of Decision: The Editorial Board's decision on publication of the paper is final and cannot be appealed elsewhere.**

**Permissions: It is the author's responsibility to have prior permission if all or parts of earlier published illustrations are used in this paper.**

Please mention proper reference and appropriate acknowledgements wherever expected.

If all or parts of previously published illustrations are used, permission must be taken from the copyright holder concerned. It is the author's responsibility to take these in writing.

Approval for reproduction/modification of any information (including figures and tables) published elsewhere must be obtained by the authors/copyright holders before submission of the manuscript. Contributors (Authors) are responsible for any copyright fee involved.

## 3. SUBMISSION OF MANUSCRIPTS

Manuscripts should be uploaded via this online submission page. The online submission is most efficient method for submission of papers, as it enables rapid distribution of manuscripts and consequently speeds up the review procedure. It also enables authors to know the status of their own manuscripts by emailing us. Complete instructions for submitting a paper is available below.

Manuscript submission is a systematic procedure and little preparation is required beyond having all parts of your manuscript in a given format and a computer with an Internet connection and a Web browser. Full help and instructions are provided on-screen. As an author, you will be prompted for login and manuscript details as Field of Paper and then to upload your manuscript file(s) according to the instructions.



To avoid postal delays, all transaction is preferred by e-mail. A finished manuscript submission is confirmed by e-mail immediately and your paper enters the editorial process with no postal delays. When a conclusion is made about the publication of your paper by our Editorial Board, revisions can be submitted online with the same procedure, with an occasion to view and respond to all comments.

Complete support for both authors and co-author is provided.

#### 4. MANUSCRIPT'S CATEGORY

Based on potential and nature, the manuscript can be categorized under the following heads:

Original research paper: Such papers are reports of high-level significant original research work.

Review papers: These are concise, significant but helpful and decisive topics for young researchers.

Research articles: These are handled with small investigation and applications

Research letters: The letters are small and concise comments on previously published matters.

#### 5. STRUCTURE AND FORMAT OF MANUSCRIPT

The recommended size of original research paper is less than seven thousand words, review papers fewer than seven thousands words also. Preparation of research paper or how to write research paper, are major hurdle, while writing manuscript. The research articles and research letters should be fewer than three thousand words, the structure original research paper; sometime review paper should be as follows:

**Papers:** These are reports of significant research (typically less than 7000 words equivalent, including tables, figures, references), and comprise:

- (a) Title should be relevant and commensurate with the theme of the paper.
- (b) A brief Summary, "Abstract" (less than 150 words) containing the major results and conclusions.
- (c) Up to ten keywords, that precisely identifies the paper's subject, purpose, and focus.
- (d) An Introduction, giving necessary background excluding subheadings; objectives must be clearly declared.
- (e) Resources and techniques with sufficient complete experimental details (wherever possible by reference) to permit repetition; sources of information must be given and numerical methods must be specified by reference, unless non-standard.
- (f) Results should be presented concisely, by well-designed tables and/or figures; the same data may not be used in both; suitable statistical data should be given. All data must be obtained with attention to numerical detail in the planning stage. As reproduced design has been recognized to be important to experiments for a considerable time, the Editor has decided that any paper that appears not to have adequate numerical treatments of the data will be returned un-refereed;
- (g) Discussion should cover the implications and consequences, not just recapitulating the results; conclusions should be summarizing.
- (h) Brief Acknowledgements.
- (i) References in the proper form.

Authors should very cautiously consider the preparation of papers to ensure that they communicate efficiently. Papers are much more likely to be accepted, if they are cautiously designed and laid out, contain few or no errors, are summarizing, and be conventional to the approach and instructions. They will in addition, be published with much less delays than those that require much technical and editorial correction.



The Editorial Board reserves the right to make literary corrections and to make suggestions to improve brevity.

It is vital, that authors take care in submitting a manuscript that is written in simple language and adheres to published guidelines.

## Format

*Language: The language of publication is UK English. Authors, for whom English is a second language, must have their manuscript efficiently edited by an English-speaking person before submission to make sure that, the English is of high excellence. It is preferable, that manuscripts should be professionally edited.*

Standard Usage, Abbreviations, and Units: Spelling and hyphenation should be conventional to The Concise Oxford English Dictionary. Statistics and measurements should at all times be given in figures, e.g. 16 min, except for when the number begins a sentence. When the number does not refer to a unit of measurement it should be spelt in full unless, it is 160 or greater.

Abbreviations supposed to be used carefully. The abbreviated name or expression is supposed to be cited in full at first usage, followed by the conventional abbreviation in parentheses.

Metric SI units are supposed to generally be used excluding where they conflict with current practice or are confusing. For illustration, 1.4 l rather than  $1.4 \times 10^{-3} \text{ m}^3$ , or 4 mm somewhat than  $4 \times 10^{-3} \text{ m}$ . Chemical formula and solutions must identify the form used, e.g. anhydrous or hydrated, and the concentration must be in clearly defined units. Common species names should be followed by underlines at the first mention. For following use the generic name should be constricted to a single letter, if it is clear.

## Structure

All manuscripts submitted to Global Journals Inc. (US), ought to include:

Title: The title page must carry an instructive title that reflects the content, a running title (less than 45 characters together with spaces), names of the authors and co-authors, and the place(s) wherever the work was carried out. The full postal address in addition with the e-mail address of related author must be given. Up to eleven keywords or very brief phrases have to be given to help data retrieval, mining and indexing.

*Abstract, used in Original Papers and Reviews:*

### Optimizing Abstract for Search Engines

Many researchers searching for information online will use search engines such as Google, Yahoo or similar. By optimizing your paper for search engines, you will amplify the chance of someone finding it. This in turn will make it more likely to be viewed and/or cited in a further work. Global Journals Inc. (US) have compiled these guidelines to facilitate you to maximize the web-friendliness of the most public part of your paper.

### Key Words

A major linchpin in research work for the writing research paper is the keyword search, which one will employ to find both library and Internet resources.

One must be persistent and creative in using keywords. An effective keyword search requires a strategy and planning a list of possible keywords and phrases to try.

Search engines for most searches, use Boolean searching, which is somewhat different from Internet searches. The Boolean search uses "operators," words (and, or, not, and near) that enable you to expand or narrow your affords. Tips for research paper while preparing research paper are very helpful guideline of research paper.

Choice of key words is first tool of tips to write research paper. Research paper writing is an art. A few tips for deciding as strategically as possible about keyword search:





- One should start brainstorming lists of possible keywords before even begin searching. Think about the most important concepts related to research work. Ask, "What words would a source have to include to be truly valuable in research paper?" Then consider synonyms for the important words.
- It may take the discovery of only one relevant paper to let steer in the right keyword direction because in most databases, the keywords under which a research paper is abstracted are listed with the paper.
- One should avoid outdated words.

Keywords are the key that opens a door to research work sources. Keyword searching is an art in which researcher's skills are bound to improve with experience and time.

Numerical Methods: Numerical methods used should be clear and, where appropriate, supported by references.

*Acknowledgements: Please make these as concise as possible.*

#### References

References follow the Harvard scheme of referencing. References in the text should cite the authors' names followed by the time of their publication, unless there are three or more authors when simply the first author's name is quoted followed by et al. unpublished work has to only be cited where necessary, and only in the text. Copies of references in press in other journals have to be supplied with submitted typescripts. It is necessary that all citations and references be carefully checked before submission, as mistakes or omissions will cause delays.

References to information on the World Wide Web can be given, but only if the information is available without charge to readers on an official site. Wikipedia and Similar websites are not allowed where anyone can change the information. Authors will be asked to make available electronic copies of the cited information for inclusion on the Global Journals Inc. (US) homepage at the judgment of the Editorial Board.

The Editorial Board and Global Journals Inc. (US) recommend that, citation of online-published papers and other material should be done via a DOI (digital object identifier). If an author cites anything, which does not have a DOI, they run the risk of the cited material not being noticeable.

The Editorial Board and Global Journals Inc. (US) recommend the use of a tool such as Reference Manager for reference management and formatting.

#### Tables, Figures and Figure Legends

*Tables: Tables should be few in number, cautiously designed, uncrowned, and include only essential data. Each must have an Arabic number, e.g. Table 4, a self-explanatory caption and be on a separate sheet. Vertical lines should not be used.*

*Figures: Figures are supposed to be submitted as separate files. Always take in a citation in the text for each figure using Arabic numbers, e.g. Fig. 4. Artwork must be submitted online in electronic form by e-mailing them.*

#### Preparation of Electronic Figures for Publication

Even though low quality images are sufficient for review purposes, print publication requires high quality images to prevent the final product being blurred or fuzzy. Submit (or e-mail) EPS (line art) or TIFF (halftone/photographs) files only. MS PowerPoint and Word Graphics are unsuitable for printed pictures. Do not use pixel-oriented software. Scans (TIFF only) should have a resolution of at least 350 dpi (halftone) or 700 to 1100 dpi (line drawings) in relation to the imitation size. Please give the data for figures in black and white or submit a Color Work Agreement Form. EPS files must be saved with fonts embedded (and with a TIFF preview, if possible).

For scanned images, the scanning resolution (at final image size) ought to be as follows to ensure good reproduction: line art: >650 dpi; halftones (including gel photographs) : >350 dpi; figures containing both halftone and line images: >650 dpi.



*Figure Legends: Self-explanatory legends of all figures should be incorporated separately under the heading 'Legends to Figures'. In the full-text online edition of the journal, figure legends may possibly be truncated in abbreviated links to the full screen version. Therefore, the first 100 characters of any legend should notify the reader, about the key aspects of the figure.*

## **6. AFTER ACCEPTANCE**

Upon approval of a paper for publication, the manuscript will be forwarded to the dean, who is responsible for the publication of the Global Journals Inc. (US).

### **6.1 Proof Corrections**

The corresponding author will receive an e-mail alert containing a link to a website or will be attached. A working e-mail address must therefore be provided for the related author.

Acrobat Reader will be required in order to read this file. This software can be downloaded

(Free of charge) from the following website:

[www.adobe.com/products/acrobat/readstep2.html](http://www.adobe.com/products/acrobat/readstep2.html). This will facilitate the file to be opened, read on screen, and printed out in order for any corrections to be added. Further instructions will be sent with the proof.

Proofs must be returned to the dean at [dean@globaljournals.org](mailto:dean@globaljournals.org) within three days of receipt.

As changes to proofs are costly, we inquire that you only correct typesetting errors. All illustrations are retained by the publisher. Please note that the authors are responsible for all statements made in their work, including changes made by the copy editor.

### **6.2 Early View of Global Journals Inc. (US) (Publication Prior to Print)**

The Global Journals Inc. (US) are enclosed by our publishing's Early View service. Early View articles are complete full-text articles sent in advance of their publication. Early View articles are absolute and final. They have been completely reviewed, revised and edited for publication, and the authors' final corrections have been incorporated. Because they are in final form, no changes can be made after sending them. The nature of Early View articles means that they do not yet have volume, issue or page numbers, so Early View articles cannot be cited in the conventional way.

### **6.3 Author Services**

Online production tracking is available for your article through Author Services. Author Services enables authors to track their article - once it has been accepted - through the production process to publication online and in print. Authors can check the status of their articles online and choose to receive automated e-mails at key stages of production. The authors will receive an e-mail with a unique link that enables them to register and have their article automatically added to the system. Please ensure that a complete e-mail address is provided when submitting the manuscript.

### **6.4 Author Material Archive Policy**

Please note that if not specifically requested, publisher will dispose off hardcopy & electronic information submitted, after the two months of publication. If you require the return of any information submitted, please inform the Editorial Board or dean as soon as possible.

### **6.5 Offprint and Extra Copies**

A PDF offprint of the online-published article will be provided free of charge to the related author, and may be distributed according to the Publisher's terms and conditions. Additional paper offprint may be ordered by emailing us at: [editor@globaljournals.org](mailto:editor@globaljournals.org) .

You must strictly follow above Author Guidelines before submitting your paper or else we will not at all be responsible for any corrections in future in any of the way.



Before start writing a good quality Computer Science Research Paper, let us first understand what is Computer Science Research Paper? So, Computer Science Research Paper is the paper which is written by professionals or scientists who are associated to Computer Science and Information Technology, or doing research study in these areas. If you are novel to this field then you can consult about this field from your supervisor or guide.

#### TECHNIQUES FOR WRITING A GOOD QUALITY RESEARCH PAPER:

**1. Choosing the topic:** In most cases, the topic is searched by the interest of author but it can be also suggested by the guides. You can have several topics and then you can judge that in which topic or subject you are finding yourself most comfortable. This can be done by asking several questions to yourself, like Will I be able to carry our search in this area? Will I find all necessary recourses to accomplish the search? Will I be able to find all information in this field area? If the answer of these types of questions will be "Yes" then you can choose that topic. In most of the cases, you may have to conduct the surveys and have to visit several places because this field is related to Computer Science and Information Technology. Also, you may have to do a lot of work to find all rise and falls regarding the various data of that subject. Sometimes, detailed information plays a vital role, instead of short information.

**2. Evaluators are human:** First thing to remember that evaluators are also human being. They are not only meant for rejecting a paper. They are here to evaluate your paper. So, present your Best.

**3. Think Like Evaluators:** If you are in a confusion or getting demotivated that your paper will be accepted by evaluators or not, then think and try to evaluate your paper like an Evaluator. Try to understand that what an evaluator wants in your research paper and automatically you will have your answer.

**4. Make blueprints of paper:** The outline is the plan or framework that will help you to arrange your thoughts. It will make your paper logical. But remember that all points of your outline must be related to the topic you have chosen.

**5. Ask your Guides:** If you are having any difficulty in your research, then do not hesitate to share your difficulty to your guide (if you have any). They will surely help you out and resolve your doubts. If you can't clarify what exactly you require for your work then ask the supervisor to help you with the alternative. He might also provide you the list of essential readings.

**6. Use of computer is recommended:** As you are doing research in the field of Computer Science, then this point is quite obvious.

**7. Use right software:** Always use good quality software packages. If you are not capable to judge good software then you can lose quality of your paper unknowingly. There are various software programs available to help you, which you can get through Internet.

**8. Use the Internet for help:** An excellent start for your paper can be by using the Google. It is an excellent search engine, where you can have your doubts resolved. You may also read some answers for the frequent question how to write my research paper or find model research paper. From the internet library you can download books. If you have all required books make important reading selecting and analyzing the specified information. Then put together research paper sketch out.

**9. Use and get big pictures:** Always use encyclopedias, Wikipedia to get pictures so that you can go into the depth.

**10. Bookmarks are useful:** When you read any book or magazine, you generally use bookmarks, right! It is a good habit, which helps to not to lose your continuity. You should always use bookmarks while searching on Internet also, which will make your search easier.

**11. Revise what you wrote:** When you write anything, always read it, summarize it and then finalize it.



**12. Make all efforts:** Make all efforts to mention what you are going to write in your paper. That means always have a good start. Try to mention everything in introduction, that what is the need of a particular research paper. Polish your work by good skill of writing and always give an evaluator, what he wants.

**13. Have backups:** When you are going to do any important thing like making research paper, you should always have backup copies of it either in your computer or in paper. This will help you to not to lose any of your important.

**14. Produce good diagrams of your own:** Always try to include good charts or diagrams in your paper to improve quality. Using several and unnecessary diagrams will degrade the quality of your paper by creating "hotchpotch." So always, try to make and include those diagrams, which are made by your own to improve readability and understandability of your paper.

**15. Use of direct quotes:** When you do research relevant to literature, history or current affairs then use of quotes become essential but if study is relevant to science then use of quotes is not preferable.

**16. Use proper verb tense:** Use proper verb tenses in your paper. Use past tense, to present those events that happened. Use present tense to indicate events that are going on. Use future tense to indicate future happening events. Use of improper and wrong tenses will confuse the evaluator. Avoid the sentences that are incomplete.

**17. Never use online paper:** If you are getting any paper on Internet, then never use it as your research paper because it might be possible that evaluator has already seen it or maybe it is outdated version.

**18. Pick a good study spot:** To do your research studies always try to pick a spot, which is quiet. Every spot is not for studies. Spot that suits you choose it and proceed further.

**19. Know what you know:** Always try to know, what you know by making objectives. Else, you will be confused and cannot achieve your target.

**20. Use good quality grammar:** Always use a good quality grammar and use words that will throw positive impact on evaluator. Use of good quality grammar does not mean to use tough words, that for each word the evaluator has to go through dictionary. Do not start sentence with a conjunction. Do not fragment sentences. Eliminate one-word sentences. Ignore passive voice. Do not ever use a big word when a diminutive one would suffice. Verbs have to be in agreement with their subjects. Prepositions are not expressions to finish sentences with. It is incorrect to ever divide an infinitive. Avoid clichés like the disease. Also, always shun irritating alliteration. Use language that is simple and straight forward. put together a neat summary.

**21. Arrangement of information:** Each section of the main body should start with an opening sentence and there should be a changeover at the end of the section. Give only valid and powerful arguments to your topic. You may also maintain your arguments with records.

**22. Never start in last minute:** Always start at right time and give enough time to research work. Leaving everything to the last minute will degrade your paper and spoil your work.

**23. Multitasking in research is not good:** Doing several things at the same time proves bad habit in case of research activity. Research is an area, where everything has a particular time slot. Divide your research work in parts and do particular part in particular time slot.

**24. Never copy others' work:** Never copy others' work and give it your name because if evaluator has seen it anywhere you will be in trouble.

**25. Take proper rest and food:** No matter how many hours you spend for your research activity, if you are not taking care of your health then all your efforts will be in vain. For a quality research, study is must, and this can be done by taking proper rest and food.

**26. Go for seminars:** Attend seminars if the topic is relevant to your research area. Utilize all your resources.



**27. Refresh your mind after intervals:** Try to give rest to your mind by listening to soft music or by sleeping in intervals. This will also improve your memory.

**28. Make colleagues:** Always try to make colleagues. No matter how sharper or intelligent you are, if you make colleagues you can have several ideas, which will be helpful for your research.

**29. Think technically:** Always think technically. If anything happens, then search its reasons, its benefits, and demerits.

**30. Think and then print:** When you will go to print your paper, notice that tables are not be split, headings are not detached from their descriptions, and page sequence is maintained.

**31. Adding unnecessary information:** Do not add unnecessary information, like, I have used MS Excel to draw graph. Do not add irrelevant and inappropriate material. These all will create superfluous. Foreign terminology and phrases are not apropos. One should NEVER take a broad view. Analogy in script is like feathers on a snake. Not at all use a large word when a very small one would be sufficient. Use words properly, regardless of how others use them. Remove quotations. Puns are for kids, not grunt readers. Amplification is a billion times of inferior quality than sarcasm.

**32. Never oversimplify everything:** To add material in your research paper, never go for oversimplification. This will definitely irritate the evaluator. Be more or less specific. Also too, by no means, ever use rhythmic redundancies. Contractions aren't essential and shouldn't be there used. Comparisons are as terrible as clichés. Give up ampersands and abbreviations, and so on. Remove commas, that are, not necessary. Parenthetical words however should be together with this in commas. Understatement is all the time the complete best way to put onward earth-shaking thoughts. Give a detailed literary review.

**33. Report concluded results:** Use concluded results. From raw data, filter the results and then conclude your studies based on measurements and observations taken. Significant figures and appropriate number of decimal places should be used. Parenthetical remarks are prohibitive. Proofread carefully at final stage. In the end give outline to your arguments. Spot out perspectives of further study of this subject. Justify your conclusion by at the bottom of them with sufficient justifications and examples.

**34. After conclusion:** Once you have concluded your research, the next most important step is to present your findings. Presentation is extremely important as it is the definite medium through which your research is going to be in print to the rest of the crowd. Care should be taken to categorize your thoughts well and present them in a logical and neat manner. A good quality research paper format is essential because it serves to highlight your research paper and bring to light all necessary aspects in your research.

## INFORMAL GUIDELINES OF RESEARCH PAPER WRITING

### Key points to remember:

- Submit all work in its final form.
- Write your paper in the form, which is presented in the guidelines using the template.
- Please note the criterion for grading the final paper by peer-reviewers.

### Final Points:

A purpose of organizing a research paper is to let people to interpret your effort selectively. The journal requires the following sections, submitted in the order listed, each section to start on a new page.

The introduction will be compiled from reference matter and will reflect the design processes or outline of basis that direct you to make study. As you will carry out the process of study, the method and process section will be constructed as like that. The result segment will show related statistics in nearly sequential order and will direct the reviewers next to the similar intellectual paths throughout the data that you took to carry out your study. The discussion section will provide understanding of the data and projections as to the implication of the results. The use of good quality references all through the paper will give the effort trustworthiness by representing an alertness of prior workings.



Writing a research paper is not an easy job no matter how trouble-free the actual research or concept. Practice, excellent preparation, and controlled record keeping are the only means to make straightforward the progression.

### **General style:**

Specific editorial column necessities for compliance of a manuscript will always take over from directions in these general guidelines.

To make a paper clear

- Adhere to recommended page limits

Mistakes to evade

- Insertion a title at the foot of a page with the subsequent text on the next page
- Separating a table/chart or figure - impound each figure/table to a single page
- Submitting a manuscript with pages out of sequence

In every sections of your document

- Use standard writing style including articles ("a", "the," etc.)
- Keep on paying attention on the research topic of the paper
- Use paragraphs to split each significant point (excluding for the abstract)
- Align the primary line of each section
- Present your points in sound order
- Use present tense to report well accepted
- Use past tense to describe specific results
- Shun familiar wording, don't address the reviewer directly, and don't use slang, slang language, or superlatives
- Shun use of extra pictures - include only those figures essential to presenting results

### **Title Page:**

Choose a revealing title. It should be short. It should not have non-standard acronyms or abbreviations. It should not exceed two printed lines. It should include the name(s) and address (es) of all authors.



## Abstract:

The summary should be two hundred words or less. It should briefly and clearly explain the key findings reported in the manuscript-- must have precise statistics. It should not have abnormal acronyms or abbreviations. It should be logical in itself. Shun citing references at this point.

An abstract is a brief distinct paragraph summary of finished work or work in development. In a minute or less a reviewer can be taught the foundation behind the study, common approach to the problem, relevant results, and significant conclusions or new questions.

Write your summary when your paper is completed because how can you write the summary of anything which is not yet written? Wealth of terminology is very essential in abstract. Yet, use comprehensive sentences and do not let go readability for brevity. You can maintain it succinct by phrasing sentences so that they provide more than lone rationale. The author can at this moment go straight to shortening the outcome. Sum up the study, with the subsequent elements in any summary. Try to maintain the initial two items to no more than one ruling each.

- Reason of the study - theory, overall issue, purpose
- Fundamental goal
- To the point depiction of the research
- Consequences, including definite statistics - if the consequences are quantitative in nature, account quantitative data; results of any numerical analysis should be reported
- Significant conclusions or questions that track from the research(es)

## Approach:

- Single section, and succinct
- As a outline of job done, it is always written in past tense
- A conceptual should situate on its own, and not submit to any other part of the paper such as a form or table
- Center on shortening results - bound background information to a verdict or two, if completely necessary
- What you account in an conceptual must be regular with what you reported in the manuscript
- Exact spelling, clearness of sentences and phrases, and appropriate reporting of quantities (proper units, important statistics) are just as significant in an abstract as they are anywhere else

## Introduction:

The **Introduction** should "introduce" the manuscript. The reviewer should be presented with sufficient background information to be capable to comprehend and calculate the purpose of your study without having to submit to other works. The basis for the study should be offered. Give most important references but shun difficult to make a comprehensive appraisal of the topic. In the introduction, describe the problem visibly. If the problem is not acknowledged in a logical, reasonable way, the reviewer will have no attention in your result. Speak in common terms about techniques used to explain the problem, if needed, but do not present any particulars about the protocols here. Following approach can create a valuable beginning:

- Explain the value (significance) of the study
- Shield the model - why did you employ this particular system or method? What is its compensation? You strength remark on its appropriateness from a abstract point of vision as well as point out sensible reasons for using it.
- Present a justification. Status your particular theory (es) or aim(s), and describe the logic that led you to choose them.
- Very for a short time explain the tentative propose and how it skilled the declared objectives.

## Approach:

- Use past tense except for when referring to recognized facts. After all, the manuscript will be submitted after the entire job is done.
- Sort out your thoughts; manufacture one key point with every section. If you make the four points listed above, you will need a least of four paragraphs.



- Present surroundings information only as desirable in order hold up a situation. The reviewer does not desire to read the whole thing you know about a topic.
- Shape the theory/purpose specifically - do not take a broad view.
- As always, give awareness to spelling, simplicity and correctness of sentences and phrases.

#### **Procedures (Methods and Materials):**

This part is supposed to be the easiest to carve if you have good skills. A sound written Procedures segment allows a capable scientist to replacement your results. Present precise information about your supplies. The suppliers and clarity of reagents can be helpful bits of information. Present methods in sequential order but linked methodologies can be grouped as a segment. Be concise when relating the protocols. Attempt for the least amount of information that would permit another capable scientist to spare your outcome but be cautious that vital information is integrated. The use of subheadings is suggested and ought to be synchronized with the results section. When a technique is used that has been well described in another object, mention the specific item describing a way but draw the basic principle while stating the situation. The purpose is to text all particular resources and broad procedures, so that another person may use some or all of the methods in one more study or referee the scientific value of your work. It is not to be a step by step report of the whole thing you did, nor is a methods section a set of orders.

#### **Materials:**

- Explain materials individually only if the study is so complex that it saves liberty this way.
- Embrace particular materials, and any tools or provisions that are not frequently found in laboratories.
- Do not take in frequently found.
- If use of a definite type of tools.
- Materials may be reported in a part section or else they may be recognized along with your measures.

#### **Methods:**

- Report the method (not particulars of each process that engaged the same methodology)
- Describe the method entirely
- To be succinct, present methods under headings dedicated to specific dealings or groups of measures
- Simplify - details how procedures were completed not how they were exclusively performed on a particular day.
- If well known procedures were used, account the procedure by name, possibly with reference, and that's all.

#### **Approach:**

- It is embarrassed or not possible to use vigorous voice when documenting methods with no using first person, which would focus the reviewer's interest on the researcher rather than the job. As a result when script up the methods most authors use third person passive voice.
- Use standard style in this and in every other part of the paper - avoid familiar lists, and use full sentences.

#### **What to keep away from**

- Resources and methods are not a set of information.
- Skip all descriptive information and surroundings - save it for the argument.
- Leave out information that is immaterial to a third party.

#### **Results:**

The principle of a results segment is to present and demonstrate your conclusion. Create this part a entirely objective details of the outcome, and save all understanding for the discussion.

The page length of this segment is set by the sum and types of data to be reported. Carry on to be to the point, by means of statistics and tables, if suitable, to present consequences most efficiently. You must obviously differentiate material that would usually be incorporated in a study editorial from any unprocessed data or additional appendix matter that would not be available. In fact, such matter should not be submitted at all except requested by the instructor.





## Content

- Sum up your conclusion in text and demonstrate them, if suitable, with figures and tables.
- In manuscript, explain each of your consequences, point the reader to remarks that are most appropriate.
- Present a background, such as by describing the question that was addressed by creation an exacting study.
- Explain results of control experiments and comprise remarks that are not accessible in a prescribed figure or table, if appropriate.
- Examine your data, then prepare the analyzed (transformed) data in the form of a figure (graph), table, or in manuscript form.

### What to stay away from

- Do not discuss or infer your outcome, report surroundings information, or try to explain anything.
- Not at all, take in raw data or intermediate calculations in a research manuscript.
- Do not present the similar data more than once.
- Manuscript should complement any figures or tables, not duplicate the identical information.
- Never confuse figures with tables - there is a difference.

### Approach

- As forever, use past tense when you submit to your results, and put the whole thing in a reasonable order.
- Put figures and tables, appropriately numbered, in order at the end of the report
- If you desire, you may place your figures and tables properly within the text of your results part.

### Figures and tables

- If you put figures and tables at the end of the details, make certain that they are visibly distinguished from any attach appendix materials, such as raw facts
- Despite of position, each figure must be numbered one after the other and complete with subtitle
- In spite of position, each table must be titled, numbered one after the other and complete with heading
- All figure and table must be adequately complete that it could situate on its own, divide from text

### Discussion:

The Discussion is expected the trickiest segment to write and describe. A lot of papers submitted for journal are discarded based on problems with the Discussion. There is no head of state for how long a argument should be. Position your understanding of the outcome visibly to lead the reviewer through your conclusions, and then finish the paper with a summing up of the implication of the study. The purpose here is to offer an understanding of your results and hold up for all of your conclusions, using facts from your research and generally accepted information, if suitable. The implication of result should be visibly described. Infer your data in the conversation in suitable depth. This means that when you clarify an observable fact you must explain mechanisms that may account for the observation. If your results vary from your prospect, make clear why that may have happened. If your results agree, then explain the theory that the proof supported. It is never suitable to just state that the data approved with prospect, and let it drop at that.

- Make a decision if each premise is supported, discarded, or if you cannot make a conclusion with assurance. Do not just dismiss a study or part of a study as "uncertain."
- Research papers are not acknowledged if the work is imperfect. Draw what conclusions you can based upon the results that you have, and take care of the study as a finished work
- You may propose future guidelines, such as how the experiment might be personalized to accomplish a new idea.
- Give details all of your remarks as much as possible, focus on mechanisms.
- Make a decision if the tentative design sufficiently addressed the theory, and whether or not it was correctly restricted.
- Try to present substitute explanations if sensible alternatives be present.
- One research will not counter an overall question, so maintain the large picture in mind, where do you go next? The best studies unlock new avenues of study. What questions remain?
- Recommendations for detailed papers will offer supplementary suggestions.

### Approach:

- When you refer to information, differentiate data generated by your own studies from available information
- Submit to work done by specific persons (including you) in past tense.
- Submit to generally acknowledged facts and main beliefs in present tense.



ADMINISTRATION RULES LISTED BEFORE  
SUBMITTING YOUR RESEARCH PAPER TO GLOBAL JOURNALS INC. (US)

Please carefully note down following rules and regulation before submitting your Research Paper to Global Journals Inc. (US):

**Segment Draft and Final Research Paper:** You have to strictly follow the template of research paper. If it is not done your paper may get rejected.

- The **major constraint** is that you must independently make all content, tables, graphs, and facts that are offered in the paper. You must write each part of the paper wholly on your own. The Peer-reviewers need to identify your own perceptives of the concepts in your own terms. NEVER extract straight from any foundation, and never rephrase someone else's analysis.
- Do not give permission to anyone else to "PROOFREAD" your manuscript.
- **Methods to avoid Plagiarism is applied by us on every paper, if found guilty, you will be blacklisted by all of our collaborated research groups, your institution will be informed for this and strict legal actions will be taken immediately.)**
- To guard yourself and others from possible illegal use please do not permit anyone right to use to your paper and files.



CRITERION FOR GRADING A RESEARCH PAPER (COMPILATION)  
BY GLOBAL JOURNALS INC. (US)

Please note that following table is only a Grading of "Paper Compilation" and not on "Performed/Stated Research" whose grading solely depends on Individual Assigned Peer Reviewer and Editorial Board Member. These can be available only on request and after decision of Paper. This report will be the property of Global Journals Inc. (US).

Topics	Grades		
	A-B	C-D	E-F
<i>Abstract</i>	Clear and concise with appropriate content, Correct format. 200 words or below	Unclear summary and no specific data, Incorrect form  Above 200 words	No specific data with ambiguous information  Above 250 words
<i>Introduction</i>	Containing all background details with clear goal and appropriate details, flow specification, no grammar and spelling mistake, well organized sentence and paragraph, reference cited	Unclear and confusing data, appropriate format, grammar and spelling errors with unorganized matter	Out of place depth and content, hazy format
<i>Methods and Procedures</i>	Clear and to the point with well arranged paragraph, precision and accuracy of facts and figures, well organized subheads	Difficult to comprehend with embarrassed text, too much explanation but completed	Incorrect and unorganized structure with hazy meaning
<i>Result</i>	Well organized, Clear and specific, Correct units with precision, correct data, well structuring of paragraph, no grammar and spelling mistake	Complete and embarrassed text, difficult to comprehend	Irregular format with wrong facts and figures
<i>Discussion</i>	Well organized, meaningful specification, sound conclusion, logical and concise explanation, highly structured paragraph reference cited	Wordy, unclear conclusion, spurious	Conclusion is not cited, unorganized, difficult to comprehend
<i>References</i>	Complete and correct format, well organized	Beside the point, Incomplete	Wrong format and structuring



# INDEX

---

---

## **D**

Defuzzification · 25

---

## **I**

Impedance · 15, 18, 20  
Infrared · 1

---

## **O**

Oscillations · 24

---

## **P**

Perturbed · 20  
Propagation · 8

---

## **R**

Rayleigh · 8  
Resonant · 15, 17  
Ripples · 26

---

## **S**

Semaphore · 4  
Simulink · 24, 25, 26, 27

---

## **V**

Vicinity · 1

---

## **W**

Wideband · 20



save our planet



# Global Journal of Researches in Engineering

Visit us on the Web at [www.GlobalJournals.org](http://www.GlobalJournals.org) | [www.EngineeringResearch.org](http://www.EngineeringResearch.org)  
or email us at [helpdesk@globaljournals.org](mailto:helpdesk@globaljournals.org)



ISSN 9755861

© Global Journals