

# GLOBAL JOURNAL

OF RESEARCHES IN ENGINEERING: E

## Civil and Structural Engineering

Capacity of Horizontal Plate

Green Demolition of Reinforced

Highlights

Review of Research Findings

Regression Modelling of California

Discovering Thoughts, Inventing Future

VOLUME 19    ISSUE 4    VERSION 1.0



GLOBAL JOURNAL OF RESEARCHES IN ENGINEERING: E  
CIVIL AND STRUCTURAL ENGINEERING

---



GLOBAL JOURNAL OF RESEARCHES IN ENGINEERING: E  
CIVIL AND STRUCTURAL ENGINEERING

---

VOLUME 19 ISSUE 4 (VER. 1.0)

OPEN ASSOCIATION OF RESEARCH SOCIETY



© Global Journal of  
Researches in Engineering.

2019

All rights reserved.

This is a special issue published in version 1.0  
of "Global Journal of Researches in  
Engineering." By Global Journals Inc.

All articles are open access articles distributed  
under "Global Journal of Researches in  
Engineering"

Reading License, which permits restricted use.  
Entire contents are copyright by of "Global  
Journal of Researches in Engineering" unless  
otherwise noted on specific articles.

No part of this publication may be reproduced  
or transmitted in any form or by any means,  
electronic or mechanical, including  
photocopy, recording, or any information  
storage and retrieval system, without written  
permission.

The opinions and statements made in this  
book are those of the authors concerned.  
Ultraculture has not verified and neither  
confirms nor denies any of the foregoing and  
no warranty or fitness is implied.

Engage with the contents herein at your own  
risk.

The use of this journal, and the terms and  
conditions for our providing information, is  
governed by our Disclaimer, Terms and  
Conditions and Privacy Policy given on our  
website [http://globaljournals.us/terms-and-condition/  
menu-1463/](http://globaljournals.us/terms-and-condition/menu-1463/).

By referring / using / reading / any type of  
association / referencing this journal, this  
signifies and you acknowledge that you have  
read them and that you accept and will be  
bound by the terms thereof.

All information, journals, this journal,  
activities undertaken, materials, services and  
our website, terms and conditions, privacy  
policy, and this journal is subject to change  
anytime without any prior notice.

Incorporation No.: 0423089  
License No.: 42125/022010/1186  
Registration No.: 430374  
Import-Export Code: 1109007027  
Employer Identification Number (EIN):  
USA Tax ID: 98-0673427

## Global Journals Inc.

(A Delaware USA Incorporation with "Good Standing"; Reg. Number: 0423089)

Sponsors: Open Association of Research Society

Open Scientific Standards

### *Publisher's Headquarters office*

Global Journals® Headquarters  
945th Concord Streets,  
Framingham Massachusetts Pin: 01701,  
United States of America

USA Toll Free: +001-888-839-7392

USA Toll Free Fax: +001-888-839-7392

### *Offset Typesetting*

Global Journals Incorporated  
2nd, Lansdowne, Lansdowne Rd., Croydon-Surrey,  
Pin: CR9 2ER, United Kingdom

### *Packaging & Continental Dispatching*

Global Journals Pvt Ltd  
E-3130 Sudama Nagar, Near Gopur Square,  
Indore, M.P., Pin:452009, India

### *Find a correspondence nodal officer near you*

To find nodal officer of your country, please  
email us at [local@globaljournals.org](mailto:local@globaljournals.org)

### *eContacts*

Press Inquiries: [press@globaljournals.org](mailto:press@globaljournals.org)  
Investor Inquiries: [investors@globaljournals.org](mailto:investors@globaljournals.org)  
Technical Support: [technology@globaljournals.org](mailto:technology@globaljournals.org)  
Media & Releases: [media@globaljournals.org](mailto:media@globaljournals.org)

### *Pricing (Excluding Air Parcel Charges):*

Yearly Subscription (Personal & Institutional)  
250 USD (B/W) & 350 USD (Color)

# EDITORIAL BOARD

GLOBAL JOURNAL OF RESEARCH IN ENGINEERING

## *Dr. Ren-Jye Dzeng*

Professor Civil Engineering, National Chiao-Tung University, Taiwan Dean of General Affairs, Ph.D., Civil & Environmental Engineering, University of Michigan United States

## *Dr. Iman Hajirasouliha*

Ph.D. in Structural Engineering, Associate Professor, Department of Civil and Structural Engineering, University of Sheffield, United Kingdom

## *Dr. Ye Tian*

Ph.D. Electrical Engineering The Pennsylvania State University 121 Electrical, Engineering East University Park, PA 16802, United States

## *Dr. Eric M. Lui*

Ph.D., Structural Engineering, Department of Civil & Environmental Engineering, Syracuse University United States

## *Dr. Zi Chen*

Ph.D. Department of Mechanical & Aerospace Engineering, Princeton University, US Assistant Professor, Thayer School of Engineering, Dartmouth College, Hanover, United States

## *Dr. T.S. Jang*

Ph.D. Naval Architecture and Ocean Engineering, Seoul National University, Korea Director, Arctic Engineering Research Center, The Korea Ship and Offshore Research Institute, Pusan National University, South Korea

## *Dr. Ephraim Suhir*

Ph.D., Dept. of Mechanics and Mathematics, Moscow University Moscow, Russia Bell Laboratories Physical Sciences and Engineering Research Division United States

## *Dr. Pangil Choi*

Ph.D. Department of Civil, Environmental, and Construction Engineering, Texas Tech University, United States

## *Dr. Xianbo Zhao*

Ph.D. Department of Building, National University of Singapore, Singapore, Senior Lecturer, Central Queensland University, Australia

## *Dr. Zhou Yufeng*

Ph.D. Mechanical Engineering & Materials Science, Duke University, US Assistant Professor College of Engineering, Nanyang Technological University, Singapore

## *Dr. Pallav Purohit*

Ph.D. Energy Policy and Planning, Indian Institute of Technology (IIT), Delhi Research Scientist, International Institute for Applied Systems Analysis (IIASA), Austria

## *Dr. Balasubramani R*

Ph.D., (IT) in Faculty of Engg. & Tech. Professor & Head, Dept. of ISE at NMAM Institute of Technology

*Dr. Sofoklis S. Makridis*

B.Sc(Hons), M.Eng, Ph.D. Professor Department of Mechanical Engineering University of Western Macedonia, Greece

*Dr. Steffen Lehmann*

Faculty of Creative and Cultural Industries Ph.D., AA Dip University of Portsmouth United Kingdom

*Dr. Wenfang Xie*

Ph.D., Department of Electrical Engineering, Hong Kong Polytechnic University, Department of Automatic Control, Beijing University of Aeronautics and Astronautics China

*Dr. Hai-Wen Li*

Ph.D., Materials Engineering, Kyushu University, Fukuoka, Guest Professor at Aarhus University, Japan

*Dr. Saeed Chehreh Chelgani*

Ph.D. in Mineral Processing University of Western Ontario, Adjunct professor, Mining engineering and Mineral processing, University of Michigan United States

*Belen Riveiro*

Ph.D., School of Industrial Engineering, University of Vigo Spain

*Dr. Adel Al Jumaily*

Ph.D. Electrical Engineering (AI), Faculty of Engineering and IT, University of Technology, Sydney

*Dr. Maciej Gućma*

Assistant Professor, Maritime University of Szczecin Szczecin, Ph.D.. Eng. Master Mariner, Poland

*Dr. M. Meguellati*

Department of Electronics, University of Batna, Batna 05000, Algeria

*Dr. Haijian Shi*

Ph.D. Civil Engineering Structural Engineering Oakland, CA, United States

*Dr. Chao Wang*

Ph.D. in Computational Mechanics Rosharon, TX, United States

*Dr. Joaquim Carneiro*

Ph.D. in Mechanical Engineering, Faculty of Engineering, University of Porto (FEUP), University of Minho, Department of Physics Portugal

*Dr. Wei-Hsin Chen*

Ph.D., National Cheng Kung University, Department of Aeronautics, and Astronautics, Taiwan

*Dr. Bin Chen*

B.Sc., M.Sc., Ph.D., Xian Jiaotong University, China. State Key Laboratory of Multiphase Flow in Power Engineering Xi'an Jiaotong University, China

*Dr. Charles-Darwin Annan*

Ph.D., Professor Civil and Water Engineering University Laval, Canada

*Dr. Jalal Kafashan*

Mechanical Engineering Division of Mechatronics KU Leuven, Belgium

*Dr. Alex W. Dawotola*

Hydraulic Engineering Section, Delft University of Technology, Stevinweg, Delft, Netherlands

*Dr. Shun-Chung Lee*

Department of Resources Engineering, National Cheng Kung University, Taiwan

*Dr. Gordana Colovic*

B.Sc Textile Technology, M.Sc. Technical Science Ph.D. in Industrial Management. The College of Textile? Design, Technology and Management, Belgrade, Serbia

*Dr. Giacomo Risitano*

Ph.D., Industrial Engineering at University of Perugia (Italy) "Automotive Design" at Engineering Department of Messina University (Messina) Italy

*Dr. Maurizio Palesi*

Ph.D. in Computer Engineering, University of Catania, Faculty of Engineering and Architecture Italy

*Dr. Salvatore Brischetto*

Ph.D. in Aerospace Engineering, Polytechnic University of Turin and in Mechanics, Paris West University Nanterre La Defense Department of Mechanical and Aerospace Engineering, Polytechnic University of Turin, Italy

*Dr. Wesam S. Alaloul*

B.Sc., M.Sc., Ph.D. in Civil and Environmental Engineering, University Technology Petronas, Malaysia

*Dr. Ananda Kumar Palaniappan*

B.Sc., MBA, MED, Ph.D. in Civil and Environmental Engineering, Ph.D. University of Malaya, Malaysia, University of Malaya, Malaysia

*Dr. Hugo Silva*

Associate Professor, University of Minho, Department of Civil Engineering, Ph.D., Civil Engineering, University of Minho Portugal

*Dr. Fausto Gallucci*

Associate Professor, Chemical Process Intensification (SPI), Faculty of Chemical Engineering and Chemistry Assistant Editor, International J. Hydrogen Energy, Netherlands

*Dr. Philip T Moore*

Ph.D., Graduate Master Supervisor School of Information Science and engineering Lanzhou University China

*Dr. Cesar M. A. Vasques*

Ph.D., Mechanical Engineering, Department of Mechanical Engineering, School of Engineering, Polytechnic of Porto Porto, Portugal

*Dr. Jun Wang*

Ph.D. in Architecture, University of Hong Kong, China Urban Studies City University of Hong Kong, China

*Dr. Stefano Invernizzi*

Ph.D. in Structural Engineering Technical University of Turin, Department of Structural, Geotechnical and Building Engineering, Italy

*Dr. Togay Ozbakkaloglu*

B.Sc. in Civil Engineering, Ph.D. in Structural Engineering, University of Ottawa, Canada Senior Lecturer University of Adelaide, Australia

*Dr. Zhen Yuan*

B.E., Ph.D. in Mechanical Engineering University of Sciences and Technology of China, China Professor, Faculty of Health Sciences, University of Macau, China

*Dr. Jui-Sheng Chou*

Ph.D. University of Texas at Austin, U.S.A. Department of Civil and Construction Engineering National Taiwan University of Science and Technology (Taiwan Tech)

*Dr. Houfa Shen*

Ph.D. Manufacturing Engineering, Mechanical Engineering, Structural Engineering, Department of Mechanical Engineering, Tsinghua University, China

*Prof. (LU), (UoS) Dr. Miklas Scholz*

Cand Ing, BEng (equiv), PgC, MSc, Ph.D., CWEM, CEnv, CSci, CEng, FHEA, FIEMA, FCIWEM, FICE, Fellow of IWA, VINNOVA Fellow, Marie Curie Senior, Fellow, Chair in Civil Engineering (UoS) Wetland Systems, Sustainable Drainage, and Water Quality

*Dr. Yudong Zhang*

B.S., M.S., Ph.D. Signal and Information Processing, Southeast University Professor School of Information Science and Technology at Nanjing Normal University, China

*Dr. Minghua He*

Department of Civil Engineering Tsinghua University Beijing, 100084, China

*Dr. Philip G. Moscoso*

Technology and Operations Management IESE Business School, University of Navarra Ph.D. in Industrial Engineering and Management, ETH Zurich M.Sc. in Chemical Engineering, ETH Zurich, Spain

*Dr. Stefano Mariani*

Associate Professor, Structural Mechanics, Department of Civil and Environmental Engineering, Ph.D., in Structural Engineering Polytechnic University of Milan Italy

*Dr. Francesco Tornabene*

Ph.D. in Structural Mechanics, University of Bologna Professor Department of Civil, Chemical, Environmental and Materials Engineering University of Bologna, Italy

*Dr. Ciprian Lapusan*

Ph. D in Mechanical Engineering Technical University of Cluj-Napoca Cluj-Napoca (Romania)

*Dr. Kitipong Jaojaruek*

B. Eng, M. Eng, D. Eng (Energy Technology, Asian Institute of Technology). Kasetsart University Kamphaeng Saen (KPS) Campus Energy Research Laboratory of Mechanical Engineering

*Dr. Burcin Becerik-Gerber*

University of Southern California Ph.D. in Civil Engineering Ddes, from Harvard University M.S. from University of California, Berkeley M.S. from Istanbul, Technical University

*Hiroshi Sekimoto*

Professor Emeritus Tokyo Institute of Technology Japan Ph.D., University of California Berkeley

*Dr. Shaoping Xiao*

BS, MS Ph.D. Mechanical Engineering, Northwestern University The University of Iowa, Department of Mechanical and Industrial Engineering Center for Computer-Aided Design

*Dr. A. Stegou-Sagia*

Ph.D., Mechanical Engineering, Environmental Engineering School of Mechanical Engineering, National Technical University of Athens, Greece

*Diego Gonzalez-Aguilera*

Ph.D. Dep. Cartographic and Land Engineering, University of Salamanca, Avilla, Spain

*Diego Gonzalez-Aguilera*

Ph.D. Dep. Cartographic and Land Engineering, University of Salamanca, Avilla, Spain



*Dr. Paolo Veronesi*

Ph.D., Materials Engineering, Institute of Electronics,  
Italy President of the master Degree in Materials  
Engineering Dept. of Engineering, Italy

*Dr. Omid Gohardani*

Ph.D. Senior Aerospace/Mechanical/ Aeronautical,  
Engineering professional M.Sc. Mechanical Engineering,  
M.Sc. Aeronautical Engineering B.Sc. Vehicle  
Engineering Orange County, California, US

*Dr. Maria Daniela*

Ph.D in Aerospace Science and Technologies Second  
University of Naples, Research Fellow University of Naples  
Federico II, Italy

*Dr. Fentahun Moges Kasie*

Department of mechanical & Industrial Engineering,  
Institute, of technology Hawassa University Hawassa,  
Ethiopia

## CONTENTS OF THE ISSUE

---

- i. Copyright Notice
  - ii. Editorial Board Members
  - iii. Chief Author and Dean
  - iv. Contents of the Issue
- 
1. Green Demolition of Reinforced Concrete Structures: Review of Research Findings. *1-18*
  2. Estimation of Uplift Capacity of Horizontal Plate Anchor in Sand. *19-37*
  3. Regression Modelling of California Bearing Ratio (CBR) Predicted from Index Properties for Lateritic Soils. *39-55*
  4. Effectiveness of Characteristic Model of Traffic Flows in Simpang 4 Road Bireun (Comparison with Greenshield, Greenberg, Underwood) Methods. *57-64*
- 
- v. Fellows
  - vi. Auxiliary Memberships
  - vii. Preferred Author Guidelines
  - viii. Index



GLOBAL JOURNAL OF RESEARCHES IN ENGINEERING: E  
CIVIL AND STRUCTURAL ENGINEERING  
Volume 19 Issue 4 Version 1.0 Year 2019  
Type: Double Blind Peer Reviewed International Research Journal  
Publisher: Global Journals  
Online ISSN: 2249-4596 & Print ISSN: 0975-5861

# Green Demolition of Reinforced Concrete Structures: Review of Research Findings

By Jing Zhu, Wenzhong Zheng, Lesley H Sneed, Chonghao Xu & Yiqiang Sun

*Harbin University of Science*

**Abstract-** The buildings and transportation infrastructures in the world are maturing rather rapidly, which lead to the maintenance, rehabilitation, retrofit, or dismantling the existing system become future trends rather than new construction. Therefore, concrete structure demolition is increasingly becoming an important issue, as more concrete structures reach their service life and require rehabilitation or replacement. Furthermore, as the bearing capacity of concrete structures are reached, partial or total removal of concrete structures become necessary to utilize the spaces of the cities widely and effectively, as well as to widen the bridge itself to increase the capacity of the transportation system. Therefore, this paper addresses an important topic. It first discusses the factors affecting the selection of concrete structure demolition technologies. Then, the paper lists and describes a number of traditional and green demolition technologies and equipment employed in concrete structure demolition along with discussions of actual structure demolition projects and experiences. Finally, the paper outlines and discusses some safety issues related to the structure demolition process.

**Keywords:** *green demolition; reinforced concrete; affecting factor; safety; pollution.*

**GJRE-E Classification:** *FOR Code: 090599*



*Strictly as per the compliance and regulations of:*



© 2019. Jing Zhu, Wenzhong Zheng, Lesley H Sneed, Chonghao Xu & Yiqiang Sun. This is a research/review paper, distributed under the terms of the Creative Commons Attribution-Noncommercial 3.0 Unported License (<http://creativecommons.org/licenses/by-nc/3.0/>), permitting all non commercial use, distribution, and reproduction in any medium, provided the original work is properly cited.

# Green Demolition of Reinforced Concrete Structures: Review of Research Findings

Jing Zhu <sup>α</sup>, Wenzhong Zheng <sup>σ</sup>, Lesley H Sneed <sup>ρ</sup>, Chonghao Xu <sup>ω</sup> & Yiqiang Sun <sup>¥</sup>

**Abstract-** The buildings and transportation infrastructures in the world are maturing rather rapidly, which lead to the maintenance, rehabilitation, retrofit, or dismantling the existing system become future trends rather than new construction. Therefore, concrete structure demolition is increasingly becoming an important issue, as more concrete structures reach their service life and require rehabilitation or replacement. Furthermore, as the bearing capacity of concrete structures are reached, partial or total removal of concrete structures become necessary to utilize the spaces of the cities widely and effectively, as well as to widen the bridge itself to increase the capacity of the transportation system. Therefore, this paper addresses an important topic. It first discusses the factors affecting the selection of concrete structure demolition technologies. Then, the paper lists and describes a number of traditional and green demolition technologies and equipment employed in concrete structure demolition along with discussions of actual structure demolition projects and experiences. Finally, the paper outlines and discusses some safety issues related to the structure demolition process.

**Keywords:** green demolition; reinforced concrete; affecting factor; safety; pollution.

## I. INTRODUCTION

As the structure and transportation infrastructures in the world matures, the work and expenditures shift from new construction to maintenance, rehabilitation, and retrofit of the existing system. Taking China as an example, some concrete structures, which still maintain their own strength enough. have a tendency to be demolished intentionally to utilize the spaces of the cities widely and effectively. According to statistics, these buildings have a life span of only 25 to 30 years. However, the average life span of buildings in Britain is 132 years, and that in the U.S. is 74 years[1]. If we do not solve the critical problems as soon as possible, the consequences of 'short-lived buildings' are quite serious, which not only cause great waste of social resources (including economy, resource, labour, energy, time, etc), but also pose a threat to the human living environment. In these demolition works, explosives such

as dynamite or heavy machines have been used, and sounds, vibrations and some other pollution are also caused[2]. Besides, the demolition of reinforced concrete structures in dense urban areas has great safety risks, and the impact of demolition accidents are extremely serious. Consequently, it is required to consider the safety and the prevention of pollution during demolition.

In addition, it is currently estimated that approximately 50% of all funds spent in the transportation area go directly for construction, maintenance, and rehabilitation of the pavements in the U.S [3]. As maintenance and rehabilitation increase, the percent of funds allocated to the pavements increases [4]. One challenge in addressing the needs of transportation infrastructure works is the increased demand on highways and bridges due to the expansion in population. This increased demand led to the need for widening a number of major highways and bridges to increase the capacity and alleviate traffic congestion. This meant that a number of overpass bridges had to be demolished to allow for the expansion of the highways underneath. Furthermore, many bridges will also need to be widened to add extra lanes, creating a need for partial demolition and reconstruction. Moreover, many bridges in the country need retrofit work to increase their resistance to natural phenomena such as earthquakes and so on. Therefore, traditional and green demolition methods and equipment are increasingly becoming important issues when buildings and transportation infrastructures rehabilitation and maintenance programs are discussed. This paper provides an overview of such methods and equipment. Advantages and disadvantages associated with each demolition technique are analyzed, and discusses some safety issues related to the buildings and transportation demolition process.

## II. BACKGROUND

The demolition industry has experienced radical transformation during the past 40 years, and it utilizes a variety of means for dismantling reinforced concrete structures. The use of jackhammers, saw cutting, wrecking balls, hydraulic excavator and water jetting are examples of traditional demolition methods (including manual demolition, mechanical demolition, blasting demolition, etc). Selective demolition is another method that has been developed. Each of these methods has

*Author <sup>α</sup> <sup>σ</sup> <sup>¥</sup>:* Key Laboratory of Earthquake Engineering and Engineering Vibration, Institute of Engineering Mechanics, China Earthquake Administration, Harbin 150080, College of Civil Engineering and Architecture, Harbin University of Science and Technology, Harbin 150080. e-mail: zhujing02@126.com

*Author <sup>ω</sup>:* Key Lab of Structures Dynamic Behavior and Control of the Ministry Education, Harbin Institute of Technology, Harbin 150090.

*Author <sup>ρ</sup>:* Department of Civil, Architectural and Environmental Engineering, Missouri University of Science and Technology, Rolla, MO, USA 65401.

advantages that make it useful for various applications [5]. It is sometimes the case, though, these methods are overall limited by rough management, low technical level, serious environmental pollution and insufficient research results about basic theories and core technologies. Therefore, chemical expansive agent and intelligent robot demolition technology have superseded crawler cranes and demolition balls. In addition to this transformation, the 'British Standard Code of Practice for Demolition', has been revised three times since its introduction in 1971. It started with CP94, which has been superseded by BS 6187: 1982 and currently by BS 6187: 2000[6]. It is the general trend to optimize the selection of suitable demolition technology and to develop innovative green and safe demolition technologies.

A case study of green demolition technique is to dismantle a hotel of Jiangsu in China. This green demolition project spent only 10 h to remove this 8,000 m<sup>2</sup> concrete frame building, while traditional demolition technique would take 10 d in the same situation. Conversely, both transportation costs are also similar. As is well known, tipping fees pose a significant cost for demolition and deconstruction, and these fees can range from \$65 to \$80 per ton. But the 100% demolition waste was recycled and reused in this project. It should be noted that zero waste is disposed after green demolition, so the overall cost of disposal is saved. In addition, this green demolition project used hydraulic scissors, diamond saw, water pressure knife, dismantling robot, mobile crusher and other high-tech means to substitute the previous jackhammers, excavator, engineering blasting and other traditional means, to achieve no noise, no dust, no vibration and non-pollution demolition. The demolition waste was carried out to sort and process on site, and the building materials such as concrete, mortar and brick and so on were recycled. Moreover, this project develops "wisdom cloud" management system of the demolition waste disposal to detect the geographical environment of the demolition project and plan out the most reasonable junk traffic lines, and the vehicle trajectory can be real-time monitored, etc. What's more, the generation and regeneration of demolition waste can also be fully digitized and transparent, and all work is ensured to process safety control, green environmental protection. Therefore, the demolition project acquires better effects of safety, green, environmental protection, high efficiency and recyclability.

### III. AFFECTING FACTORS OF CONCRETE STRUCTURE DEMOLITION METHODS

Concrete structure demolition projects typically involve the use of one or more of the demolition methods discussed in this paper. The choice of what demolition method(s) to use on a particular project

depends on the following factors: (1) Financial; (2) Time limits imposed on a project; (3) The strength and quality of the concrete; (4) The shape, size, and accessibility of the structure; (5) The amount of concrete to be removed; (6) Environmental concerns, including noise, dust, vibrations, and debris; (7) Worker safety and public safety; (8) Possible recycling of concrete; and (9) Removal, transport, and disposal of debris.

On structure demolition projects, safety is of prime importance among these key factors to consider. All movements of people within the structure should be along designated routes, and debris should not be allowed to accumulate to a weight greater than a floor can carry. When demolishing a structure from the top down, no supports at a lower level should be cut or removed until demolition at the upper level is completed[7]. Workers must always stand on a firm base while carrying out demolition. For another, on bridge demolition projects, preventing inconvenience to the public is often of prime concern. Keeping lanes open during demolition, or a speedy demolition and removal of a bridge structure to prevent traffic problems on roadways running below the structure, may be factors that control the choice of demolition methods. Restrictions on noise, dust, or vibrations may be imposed on demolition projects in urban areas. Bridges or roadways crossing environmentally sensitive waterways may need to be removed using cleaner methods, which do not create debris. These are only a few of the examples that will be discussed in the paper.

### IV. TRADITIONAL DEMOLITION TECHNOLOGIES

For a long time, traditional demolition technologies (including manual demolition, mechanical demolition and blasting demolition) are the main methods of removing the reinforced concrete structures. Demolition methods vary according to building location, construction materials, disposal techniques and the ultimate demolition goal. Reinforced concrete structures should be dismantled step by step as construction works. Knowing which method or combination of methods to use for demolition of reinforced concrete structures is essential for a safe and profitable job as well as prevention of pollution demolition [2]. At present, hydraulic excavators with specialist attachments are used for almost every conceivable demolition work from dismantling the roof to breaking up and removing the foundations, replacing the once dominant crawler cranes and demolition balls. However, their use on demolition projects is not straightforward in practice due to complicated site conditions and other constraints. Selection of the best method or methods depends partly on time and money available and on the technological level [8].



There are many types of demolition techniques in the industry. Many of them are used together. Kasai et al [9] stated that the demolition techniques could be classified into eleven principles and mechanisms, while in code of practice for demolition BS 6187: 1998, the demolition techniques are listed into seven categories[5,10]. In this section, demolition methods and equipment available for the full and partial removal of reinforced concrete buildings and bridges are provided. This following information outlines the different types of traditional approaches and demolition services a modern demolition company such as Elder Demolition is likely to offer. The section describes the following methods.

- Demolition by hand
- Saw cutting
- Ball and crane

- Hydraulic excavator
- Water jetting
- Hydraulic splitter
- Thermal lance
- Explosive

Each method will be discussed along with its advantages and disadvantages. Then, example projects will be highlighted and described. Table I provides a summary description of traditional demolition technologies. The following discussion of conventional methods used is based primarily on their widespread application, and the techniques are provided by relational codes (including Code of Practice for Demolition of Buildings Year 2004), research and demolition experience.

Table 1: Summary of Traditional Demolition Technologies of Concrete Structures

Method	Applications	Production (m <sup>3</sup> /h)	Advantages	Disadvantages
Demolition by hand	Demolition of floor slabs, bridge, piers, and pavements	6~17	simple to operate, strong mobility, effective in narrow and localised place, precisely removal, well recycled materials	Noise, dust, and vibration, low efficiency, crowd tactics, high demolition cost
Saw cutting	Partial removal of deteriorated concrete, removal of free-standing walls, dismantlement concrete slabs and wall elements containing reinforcement	0.07~0.6	No dust, no vibration, and produces clean edges, easy to operate	Difficulties arise around rebar, slow and costly, noisy, blade wear, additional safety requirements and procedures of workers because of noise, cooling water needed to deal with
Ball and crane	Demolition of dilapidated buildings, silos and other industrial facilities, bridge removal	—	Workers safety, simplicity of the operation	Control of the swing, large amounts of dust, noise, and vibrations, substantial clear space and high clearance
Hydraulic excavator	Full and partial structure and bridge removal, isolated buildings	Up to 2	No dust, low noise, no vibrations, great mobility, operable in inclement weather, rapid and safe cutting of rebar	relatively flat ground, adequate counter-weight, water spray, protecting the operator
Water jetting	Partial removal of deteriorated concrete slabs and bridge decks	1.4~4.3	Minimum labor, low noise, no dust, no vibration, and very accurate cutting, high production rate, remaining concrete surface irregular allowing good bonding to new concrete	Rebar shadow problems, costly, large quantities of water needed, dangerous due to the high pressures used, and disposal of the water that is mixed with debris, adequate protection operator

Hydraulic splitter	Full and partial structure and bridge removal	For splitter method, rate depends on hole pattern, hardness of concrete, and orientation of rebar	No vibration, inexpensive, little dust, remaining concrete undamaged, accurately control, dismantling precision, fair inexpensive-ness, high safety degree, fast speed, working continuously without interruption, high efficiency, and can be used underwater, small effect for surrounding environment, limited skills for requiring the operator	Time consuming and requires the use of breakers to expose rebar, splitter is usually employed as secondary means of separating and removing the concrete
Thermal lance	Method is new with potential applications in the partial removal of concrete	Cutting speed is 20-40 cm/min and depends on quality of concrete, type of aggregates, amount of rebar, and skill of operator	No vibration, low noise, can be used in places that are not easily accessible, and can be used underwater	Cost, fire hazard, and generates large amount of fumes, adequate protective measures for the workers
Explosive	Full and partial structure and bridge removal	Not applicable	Speed, short durations of noise and dust	Dust, noise, vibrations, flying debris, and dangerous

a) Demolition by hand

Demolition by hand is that the workers are equipped with air picks, jack hammer or pneumatic breaker to dismantle the concrete on a floor by floor downward sequence, and then the steel reinforcement is cut and removed with gas welding, which is the most widely used method and one of main types of demolition techniques.

The advantages of demolition by hand include the following:

- Manual removal of equipment is simple to operate, and the operation is strong mobility, and the concrete structures can be precisely removed.
- The maximum limit to reduce the impact of the demolition of the surrounding structure. It is effective in narrow and localised place, and efficient for simple structure.
- Old materials are well recycled.

However, some difficulties encountered with the demolition by hand are: due to manual operation, the efficiency of demolition by hand is low, and generally take the crowd tactics, so the requirements for engineering management are higher. Scaffolding is needed during demolition, and electric air compressor and other mechanical equipment are needed, which leads to high demolition cost. In the demolition, there is

lots of noise and dust on site, and the impact on the surrounding environment is large. Therefore, before the demolition, the contractors need to do a good job with the surrounding residents coordination [11].

The usage or application areas for demolition by hand are to separate structure to be demolished from adjacent structures or from remaining adjoining, work near to live services or public area, where site or safety restrictions prevented mechanical demolitions, where the demolition has to be carefully controlled, site involving contamination, stripping out soft strip material such as door/window frames. For structural projections, such as balconies, canopies and verandahs extending beyond the building lines, demolition by hand held tools or the cut and lift process may be a safe solution[10].

b) Saw cutting

Saw cutting is suitable for alteration and additional works where accuracy in the cutting is important and the tolerance to noise and vibration is very limited. It can be used to cut concrete slabs and wall elements containing reinforcement into segments. and vary in thickness from several inches to several feet. In general, cutting methods are considered slow and costly for removal of large volumes of material from mass concrete structures. However, these may be secondary concerns when demolition criteria demand

precision, reduced vibration, and reduced damage to the material that remains [12]. Saw cutting generally includes conventional disc saw and chain saw, rotary-action diamond saws and wire saw.

Rotary-action diamond saws are the most common type of saw used to cut concrete. These saws produce straight precision cuts up to 21 in. deep in concrete by the high-speed grinding action of the saw blade. In the past, rotary-action diamond saws have been successfully used for building and highway demolition. In particular, these saws have been cost-effective for removal of free-standing walls. In general, the rotary-action diamond saw can be electrically or hydraulically powered or driven by a combustion engine. The blade is a thin rotary disc with diamond-tipped teeth along its outer perimeter. Lubricant is supplied to the blade through a hose connected to a lubricant storage container [13].

The advantages of rotary-action diamond saws include:

- Precision cuts can be made with minimal vibration and damage to concrete that remains.
- Relatively large sections can be removed at one time, and the surface of the cut concrete is smooth and relatively regular [2].
- Cooling water was used to cool the saw, so no dust is produced. Sawing produces negligible vibration and dust.
- A relatively safe operation can be maintained.
- The cutting equipment is light and easy to transport to the structure, and easy to operate.
- It will hardly affect the surrounding environment, completely meeting the requirements of green construction.

On the contrary, the disadvantages of saw cutting include: a. the cutting operation is slow and costly. b. Cutting depths are limited. c. The number of shapes that can be cut is limited. d. During the cutting operation, lubricant must be continuously applied to the blade to cool it and protect it from excessive wear. But cutting reinforced concrete increases blade wear and hence operation costs. e. Some additional safety requirements and procedures are necessary due to the high level of noise produced (see EM 385-1-1). f. It may be noisy and require equipment to supply and clean up the large quantity of water used to cool the saw. The cooling water will form dirty mud water [14]. g. Before a cutting operation begins, utility lines within the concrete in the vicinity of the cutting should be located and marked. h. The size and location of the reinforcement should also be determined before starting an operation. i. The cutting pattern should yield sections of satisfactory size to ensure safe handling for the equipment available for removal.

In one China case study, T1, T2 viaduct demolition project of Huanghua International Airport in Changsha applied saw cutting and BIM technology as the core of the new green cutting technology, which is faster than the traditional sawing cutting speed, greatly shorten the construction period; In the demolition process, there is no vibration, no pollution and no noise. The application of water collecting system in sawing cutting truly realizes zero discharge of polluted water and minimizes the adverse impact of demolition construction on Huanghua Airport and the surrounding environment. The application of BIM technology in demolition construction greatly reduces the difficulty of sawing cutting, and plays an active role in the design and implementation of sawing cutting. Engineering practice has proved that the new green sawing cutting technology studied, improved and optimized has effectively guided the demolition and construction of T1 and T2 viaducts in the transformation project of the liaison line of Huanghua International Airport of Changsha with good social and economic benefits.

#### c) *Ball and crane*

This is one of the oldest and most commonly used methods for building demolition. A crane uses a wrecking ball, typically weighing from 1,000 lb to 13,500 lb [2,15], which is either dropped onto or swung into the element to be demolished. Concrete members can be broken into small pieces, but secondary cutting of reinforcing may be necessary. Most importantly, the crane operator must be highly skilled to ensure maximum safety during the demolition operation.

The advantages of ball and crane demolition include:

- It is safety of project workers, because they are not required to be inside the collapse envelope of the structure during the demolition operation [16].
- It is simplicity of the operation.

On the other hand, the disadvantages of ball and crane include: It relates to the control of the swing of the ball. Missing the desired target may tip or overload the crane and a wild swing-back of the ball may cause it to hit the boom [2]. Obviously, care must also be taken when operating around power lines. Additionally, the height of a building that can be demolished is limited by crane size and working room; however, buildings as high as 20 stories have been demolished [2]. What's worse, demolition using a ball and crane can create large amounts of dust, noise, and vibrations [17]. To minimise the dust impact on the surrounding area, the structure to be demolished shall be pre-soaked with water before demolition. Water spraying shall continue on the structure during demolition [18].

To ensure safe operation of a crane using a wrecking ball, the National Association of Demolition Contractors provides guidance for the safe operation of a crane using a wrecking ball. The ball weight should not exceed 50% of the safe load of the boom at maximum length or angle of operation, or 25% of the nominal breaking strength of the supporting line, whichever is less. The demolition ball should be attached to the load line with a swivel-type connection to prevent twisting of the load line. Taglines may help control the ball during the swinging operation. Smoothness in controlling the swing of the ball is important.

This method is suitable for dilapidated buildings, silos and other industrial facilities. However, the operation requires substantial clear space. The application also demands high level skill operators and well-maintained equipment. The safety hazards of cranes operating near electrical wires are well known. The absolute limit of approach for a crane boom near a power line is 10 feet. A signalman must be assigned to warn the operator when he is nearing the limit of approach [19].

#### d) *Hydraulic excavator*

Hydraulic excavator, with specialist attachments such as crushing hammer, pusher arm, wire rope and clam shell, is used for almost every conceivable demolition work from dismantling the roof to breaking up and removing the foundations, replacing the once dominant crawler cranes and demolition balls. However, its use on demolition projects is not straightforward in practice due to complicated site conditions and other constraints. The concerns and good practices of the mechanical demolition generally included the following: (1) These methods shall only be applied to isolated buildings on relatively flat ground. It shall also have adequate counter-weight to prevent overturning during the operation; (2) The equipment and accessories such as attachments and rope shall be inspected frequently and shall be repaired or replaced whenever necessary; (3) Sufficient water spray or other anti-dust precautions shall be provided to minimise air pollution by dust; (4) The cab of the machine shall be equipped with impact proofed glass and its construction shall be robust enough to protect the operator from flying debris[20].

The demolition method of hydraulic excavator has many advantages:

- Flexibility, convenient use, good maneuverability, strong adaptability, and the ability to strip or cut steel reinforcement.
- It can be used to break up all kinds of concrete structures and rocks and get good economic benefits [21].
- It is suitable for densely populated or built-up areas, and the structure is the small and medium-sized

building structure under the height of 15m to dismantle.

- It is also suitable for the construction period is not tight.
- In many cases, the comprehensive demolition cost of excavator demolition method is lower than that of blasting demolition.

Nevertheless, the main disadvantages of the demolition method of hydraulic excavator are noise, dust and vibration, low efficiency, long construction period, many unsafe hidden dangers, relatively poor comprehensive benefits. In addition, it may be restricted in areas of limited work space [22].

At present, the most significant technological progress of crushing hammer is intelligent crushing hammer. It can automatically monitor and adjust its output shock energy and shock frequency characteristics according to the crushed objects. When a solid structure (hard) is broken, the single impact energy is automatically increased and the impact frequency is reduced to make it more capable of breaking; When the non-solid structure (soft) is broken, crushing hammer can automatically accelerate the impact frequency, reduce the single impact energy, so that the crushing hammer has higher production efficiency. And when the structure is broken, it will reduce or stop output, in order to protect the hammer, extend its service life.

#### e) *Water jetting*

Water jetting involves the use of a water jet stream pumped at high pressure to erode the cement matrix and wash out the aggregates. Moreover, BS 6 187:2000 defined high-pressure water jetting as "all water jetting processes including those using additives and abrasives where there is energy input to increase the pressure of water. In demolition the process is used, e.g. for cutting out concrete from around steel reinforcing bars where the latter are to remain". For example, a high-pressure water jet about 250-300 MPa from a nozzle about 0.3-0.5 mm in diameter can cut through plain concrete by abrasion [6]. Its usage or application areas are: where hot cutting or work is not allowed e.g. chemical plant, where need to cold cut steel in areas such as refineries, where vibration must be avoided, with contaminated equipment or explosive atmospheres, vessels previously containing flammable or toxic material (radioactive). Reference should be made accordance with the Water Jetting Association Code of Practice [23].

The advantages of water jetting include:

- It is minimum labor, low noise, no dust, high production rate, no vibration, minimising dust and fire hazards,
- Remaining concrete surface irregular allows good bonding to new concrete [3].

However, the disadvantages are rebar shadow problems, it is costly, needs large quantities of water, and disposal of the water that is mixed with debris. In addition, large fragments of aggregate and other debris are sometimes dislodged and ejected from the cut with considerable force. This hazard requires the operator to wear adequate protection and the cutting area to be kept clear of other personnel [12].

The productivity of the water jet has greatly improved over the last decade, and it is now becoming competitive with some of the other removal devices. Improvements that are under development should make the water jet even more competitive. The water jet has the potential for being a primary means for removal when it is desired to preserve the reinforcement within the removal area for reuse. However, at present, the water jet, like other cutting devices, may be better used in support of primary removal methods [24].

Demolition by high pressure water jetting was used in bridges, independent chimney, basement and retaining wall, masonry and brick arches, vessels and tunnels. The research results also indicated that the water jetting was used in practice and the combinations of different techniques are usually employed.

#### f) *Hydraulic splitter*

Due to the low tensile strength of concrete, hydraulic splitter [25] can easily dismantle large sections of concrete structures. Holes ranging from 1 to 2 inches in diameter are drilled into the concrete. The wedge of splitter is inserted into the hole and the subsequent hydraulic pressure forces the concrete to split. Controlling the crack direction and the movement of the demolished mass may be difficult using hydraulic splitter. Additionally, when reinforced concrete is being split, it is almost always necessary to utilize a hydraulic or pneumatic breaker, either hand-held or machine-mounted to expose the reinforcing bars for cutting.

Hydraulic splitter has many advantages:

- It is accurately control, dismantling precision, fair inexpensiveness, high safety degree, fast speed, working continuously without interruption, high efficiency.
- The surrounding environment will not be impacted, especially it can be used closing to the precision equipment, and they can be used underwater.
- It is quiet and does not cause vibration, fly rock, or dust other than that yielded by drilling and secondary breaking operations. This can be overcome by coring the holes with a diamond-tipped coring machine, but at far greater cost [2].
- The splitter is best suited for shallow holes at any angle. It can be used on wall surfaces and in areas of limited work space.
- Limited skills are required by the operator.

However, its disadvantages include: for removal of surfaces from mass concrete structures, control of crack plane depth is somewhat limited. It requires the use of breakers to expose reinforcement for cutting. Secondary means of breakage are often required to separate and break sections to increase efficiency in handling and removal work. It is a time consuming process, so the concrete splitter is usually employed as secondary means of separating and removing the concrete, which adds to the cost of removal.

Hydraulic splitters have been used at Corps projects such as Hiram M. Chittenden Lock, Seattle District, in the removal of an existing fish ladder structure and Markland Dam, Louisville District, in the removal of pairs of reinforced blocks atop downstream pier stems. Splitters have been used on a variety of other types of structures such as bridges, nuclear reactors, retaining walls, and concrete bank vault walls. They are most suitable for large volume plain concrete demolition and rock excavation cooperated with crusher [26].

#### g) *Thermal lance*

Thermal lance means a high temperature torch with heat source generated from fusion of oxygen and metal to melt concrete and rebars [27]. And specifically, the heat is generated using flame, plasma, or laser beam. In the flame process, a 13-17 mm (0.5-0.7 in.) o.d. pipe that contains iron or aluminum alloy wire is used. The alloys are ignited using acetylene gas to obtain a high temperature of 2,000 - 4,000°C, which are applied to the concrete [3]. The cutting speed of the thermal lance is 200~400 mm/min. The cutting speed of silica aggregate is generally faster than that of limestone aggregate. Because of the steel bar reacts with oxygen to produce high temperature, so steel plate and steel bar cutting faster than concrete. In addition, cutting speed also depends on the smoothness of discharge of the molten slag.

The advantages of this method include:

- It is no vibration, a low noise level, it can be used underwater.
- It is not hampered by the presence of steel plates or steel frames, and it can be used in places that are not easily accessible, and it's easy to control with a robot.
- Thermal lance may be used like the diamond saw to improve crack control and reduce over breaking [12].
- It is especially practical and effective for cutting reinforced concrete.
- Thermal lance can be used to remove surfaces from mass concrete structures.
- Protective concrete structures from nuclear reactors can be dismantled with thermal lance, but radioactive smoke has to be collected by cutting decommissioned nuclear reactor equipment.



The disadvantages of thermal lance are that it is slow and costly when compared to mechanical methods, molten slag may cause fire, and the process generates large amounts of fumes that require a good ventilation system. Thus, the use of a thermal lance in cutting reinforced concrete shall not be used unless: (a) The project demonstrated that there is no other viable alternative; (b) Adequate protective measures are provided to isolate the operation and to prevent any potential fire spreading out; and (c) Adequate protective measures are provided to prevent the injury of the workers, and any third party by flame and the molten concrete.

#### h) Explosives

By detonating explosives, blasting methods employ rapidly expanding gases confined within a series of boreholes to destroy the building support structure and produce controlled fractures which provide for easy concrete removal. In general, blasting methods are most cost-effective and expedient means of removing large volumes of distressed or deteriorated concrete [28]. But, due to dangers inherent in handling and usage, blasting is considered most dangerous and requires more stringent controls than any other methods of demolition. For the demolition of concrete structures, it is usual to drill holes at a predetermined angle into the concrete to be removed. The holes are then charged with an explosive which is electrically detonated. Empirical judgment based on the skill and experience of the operator is the basis for blasting design. Recent advances in blasting design include the utilization of recognized formulas and calculations which determine the position, angle and depth of the borehole, as well as the size of the charge. A simpler but far less effective method of blasting is to lay the explosive charge on the element to be demolished and cover it with sandbags. Another method, particularly useful for containers, is to fill the structure with water and detonate an explosive charge which has been suspended at the center. The water transmits shock waves to the surrounding walls. Shaped charges for the directional cutting of elements are also available.

The explosive method has many good characteristics:

- It is high speed and efficiency, and low comprehensive cost.
- Before blasting period, it does not account for the construction period. And after the completion of blasting, the wastes can be cleaned up, so it does not affect the next process of structure construction, and cleaning other parts does not occupy the main progress.
- The benefits of demolition by blasting are low labor intensity, short construction period.

- It can avoid to bring disturbance for the surrounding people due to long-term construction.

However, the explosive method will produce some negative effects due to blasting: the strong shock wave will cause great safety hazards to the surrounding environment, which produces vibration, blasting flying stone, dust, etc. The contractors need to be strict technical measures to avoid the surrounding environment being affected. Due to the rapid development of blasting technology, the technical parameters of blasting are restricted and supplemented by other auxiliary measures, such as setting up protective shed and covering. Thus, the method of covering protective blanket can reduce dust, vibration and noise caused by blasting. detonation. The rational improvement and utilization of blasting technology is very helpful to the development of concrete structure demolition technology [11].

In summary, explosives are versatile and have great flexibility in terms of work output. Nevertheless, excessive ground vibration may damage adjacent structures and air blast may cause superficial damage such as window breakage elsewhere. The National Association of Demolition Contractors states that the use of explosives to demolish entire buildings or portions shall not be permitted unless there is sufficient clear space in all directions equal to 75% of the height of the building being demolished. Precautions should be taken to stop flying debris and in all circumstances strict site control must be maintained to ensure the safety of workers and the general public [2].

The rapid development of explosive technology makes it widely used in engineering construction applications. At present, the commonly used explosive demolition method is mainly shallow hole differential blasting technology: drilling holes according to the design hole mesh size on the support beam, loading explosives and millisecond lightning tube, method of removing the supporting beam after initiation.

Successful blasting case studies-Blasting has been used in Germany quite extensively to remove bridges crossing over roadways. Blasting causes traffic tie-ups (and detours) to relatively short periods of time, which are planned when traffic is light [29]. Another case is that explosives were used on the Sunshine Skyway Bridge (Tampa Bay, Fla.) demolition project, which called for the removal of 61,200 m<sup>3</sup> (80,000 cu yd) of concrete and 6,182,000kg (6,800 tons) of structural steel [30]. Concrete decks, hand railings, etc, were removed using concrete veneer saws, hydraulic shears, and hoe rams. The steel truss portion of the bridge was cut into pieces using explosives. The concentrated explosive charges burned through the steel much like a high-speed cutting torch. The pieces were then removed using barges. The concrete piers were demolished in two stages using a high quantity of

explosives packed into drill holes. The blast, which sent concrete debris flying 44 m (125 ft) into the air, effectively fragmented the concrete. To prevent any harm to marine life, a special precaution was taken prior to blasting the piers below the water line. This consisted of detonating small charges to scare away the marine life [3].

### V. GREEN DEMOLITION TECHNOLOGIES

At present, most of the demolition projects undertaken are complex in nature demanding greater skill, experience and precision than ever before. In addition, more legislation that is stringent and growing commercial and environmental pressure have made a major impact on the selection of demolition techniques. Furthermore, various types of new demolition techniques are available in the demolition industry, which make the selection more complex.

In addition, urban residence construction is in the stage of rapid development, so the number of high-rise and super-high-rise buildings in the city shows a

high-speed growth trend. The traditional demolition technologies have many problems such as loud noise, dust pollution and obvious vibration, which often bring many bad effects to the surrounding environment. It is contradictory with the requirement of green environmental protection, especially in the prosperous areas of some cities. Therefore, green demolition technologies of reinforced concrete structures have been widely used and developed. The novel eco-friendly green demolition technologies are as follows:

- Electric heating method
- Chemical expansive agent
- High-voltage pulse technology
- Resonance demolition method
- Cut & down construction method
- Drilled core demolition technology
- Intelligent robot demolition technology

Green demolition technologies improve the demolition safety and prevent the pollution. Table 2 provides a summary description of green demolition technologies [3, 31-33].

Table 2: Summary of Green Demolition Technologies of Concrete Structures

Method	Applications	Production (m <sup>3</sup> /h)	Advantages	Disadvantages
Electric heating method	Demolition of reinforced concrete structures. removal of the concrete protective shell of nuclear reactor	0.12~0.14	Easy to control and recycle, easier to set coils on the concrete surface, no noise, no vibration, no dust, no explosive, lower hazards to workers, safety and environmental protection	Peeling down the concrete cover, expensive; the heating coil needs to be cooled, high-power equipment
Chemical expansive agent	Full and partial bridge removal, a restrictive environment where noise, flying debris and vibration are less tolerated, foundation works, pile caps or structures	For this method, rate depends on hole pattern, hardness of concrete, and orientation of rebar	No vibration, no noise, safety, and nonexplosive, easy to complete	Costly, more time, specialized and well-protected workers, cutting the reinforcement
High-voltage pulse technology	Demolition of reinforced concrete structures in town populated environment	Rate depends on voltage pattern, hardness of concrete, electrolyte or fuse type	No flying stones, no dust, no noise, and no toxic or harmful substances, efficient and controllable. effective, directionality, high energy utilization efficiency	Expensive, high working voltage, bulky generator, unfavorable handling, serious ablating electrode, insufficient

				attention to safety and insulation problems, holes being drilled to insert electrodes
Resonance demolition method	This method is still in the experimental stage of development, removal a small number of non-load-bearing or a small number of load-bearing structure	Rate depends on frequency, the responses (displacement, stress, etc.) of forced vibration	No dust, no noise, economical, green and safe, high energy utilization efficiency, easy to recycle resources	Dismantling in blocks, and the erecting of the resonator being more troublesome
Cut & down construction method	Dismantling concrete structures	0.03	Enclosed construction environment, efficiency, more eco-friendly, no dust, no noise and no vibration, no damage to the surrounding buildings, no waste thrown down from height, no need to move the personnel and waste up and down, and the security is higher, CO <sub>2</sub> emission is reduced, materials are classified to recycle, the decoration materials recovery rate is up to 93%	Large tonnage multi-point hydraulic synchronous jacks being needed, experienced operator
Drilled core demolition technology	Removal the elements of reinforced concrete structure with relatively dense steel bars, demolition of reinforced concrete support elements	Rate depends on drill type, drill diameter and length	Simple working procedure, easy access to use machinery and low cost. high construction accuracy, high speed and no dust pollution, the concrete surface is smooth, no need for other fixed devices	Low efficiency, more time

Intelligent robot demolition technology	In the situation of hazardous or potentially dangerous situations arise, pre-weakening of structures for demolition by explosives, unstable structures, Nuclear contamination	—	It can engage in high-risk demolition operations and reduce casualties, it can greatly improve the efficiency of demolition and reduce dust pollution caused by demolition, minimum labor results in reduced cost, more energy efficient, more reliable, it is suitable for places with limited space	—
---	---	---	---	---

a) *Electric Heating Method*

To address the problems of disturbing people and environmental impacts during demolition, Japanese researchers have carried out a series of experiments with the electric heating methods. There are two categories of electric heating methods: (1) direct heating method; (2) induction heating method.

Direct heating method has become the development focus of green demolition technology. The two ends of the reinforcement are exposed in direct heating method and electrodes are installed. Low voltage (25V) and high alternating current are directly applied to generate resistance loss of heat, resulting in the expansion of steel reinforcement. The thermal expansion of steel reinforcement and surrounding concrete produces tensile stress in concrete, and a continuous crack in the heated steel bars breaks the bond between the steel bars and the concrete. Then concrete around the crack can be easily knocked off by using a chisel or hydraulic hammer. Ultimately, concrete cover can be removed by cracking and delamination occurs by electrically heating the reinforcing steel[15]. Heating steel bars is beneficial to peel off the concrete cover. The rebar can be heated to 400~500°C. This temperature value is usually achieved in 7~8min. The frequency of the heater used is 400 Hz and the maximum voltage is 25 V or 50 V. The current is 2,300 A or 1,150 A.

The advantages of direct heating method are as follows:

- This method uses electric energy, so it is easy to control.
- The noise and vibration are negligible during removing the concrete cover.
- The concrete and steel are chipped away in blocks, so the dust produced is minimal.

- The hazards to construction workers and the environment are reduced because of no explosives.
- It is a new safety and environmental protection method for the demolition of reinforced concrete structures.

Because of the above advantages, this method has been used for drilling underground diaphragm wall. Moreover, this method applied to remove the concrete protective shell of nuclear reactor works well. However, the drawback of direct heating method is that the electrodes need to be attached to the steel, so the concrete cover is cut open to expose the two ends of the steel for heating.

Induction heating method uses an induction coil to expose the steel bars buried in concrete to an alternating magnetic field, and generates stray currents in the steel bars. The resulting loss of resistance is used to heat the steel reinforcement and crack the concrete. The method was tested by Japanese researchers in 1978, using C-shaped magnets. The researchers created an alternating magnetic field using an eddy current flat coil. The frequency is 3 Hz, 32 Hz and 200 kHz, and the power is 100 kW and 200 kW, which is used to heat a specimen with concrete cover of 100 mm and steel reinforcement diameter of less than 35 mm or 38 mm. At 200 kW, the temperature increase is much larger than at 100 kW. The test results show that no significant difference between the frequencies of 3 Hz, 32 Hz and 200 kHz [33].

This method has the same advantages as the direct heating method, and it is easier to set coils on the concrete surface. However, the following problems need to be solved: (1) Induction heaters are expensive; (2) An appropriate method must be developed to cool the



heating coil; (3) Heating steel reinforcement with a thick concrete cover requires high-power equipment.

#### b) *Chemical expansive agent*

Chemical expansive agents undergo a large increase in volume when properly mixed [34-37]. These agents are placed in holes drilled in concrete in a predetermined pattern. Once the expansions of the mixture by hydration cause the splitting of the concrete and a fracture (BS 6 187, 2000) [6]. The chemical composition of these agents consists of calcium oxide that expands when hydrated [3]. Chemical expansive agent is a suitable application in a restrictive environment where noise, flying debris and vibration are less tolerated. A drilling pattern shall first be designed. For large projects, test breaking shall be performed. Secondary efforts are required to further break down and remove the debris by mechanical means.

The advantages of chemical expansive agents include:

- They are nonexplosive, so no vibration, noise, fly rock, or dust is produced other than that produced by drilling and secondary removal methods.
- Reasonably safe operation can be maintained.
- It can be used to presplit large sections of concrete for removal.
- It can be used to propagate vertical crack planes of significant depth for controlled presplitting within a mass concrete structure.
- Limited skills are required by field personnel.

The disadvantages of chemical expansive agents include: The overall operation is somewhat costly when drilling and secondary removal expenses are included, and it takes more time to complete a demolition job with chemical expansive agents than with hydraulic splitters or explosives. Demolition by chemical expansive agents is highly specialized activity and must be undertaken only by, or under supervision of trained personnel. Control of crack plane depth is somewhat limited. As the agent will irritate the skin and eyes, the rubber gloves and goggles are worn to protect the worker. Secondary means are required to complete separation and removal of the concrete section from the structure. For reinforced concrete, a means of cutting the reinforcement must be employed. A couple of days may be required before presplitting becomes optimum. Any large voids in a borehole are usually not detected until an excessive amount of agent has been used.

In addition, the chemical agent is formulated to be used at a certain temperature, and any deviation from this temperature will reduce the expected expansive pressure. Freezing the chemical agent will greatly reduce its effectiveness [2]. Chemical expansive agent may be used on foundation works, pile caps or structures that are fully supported [10].

#### c) *High-voltage Pulse Technology*

High-voltage pulse technology has been identified as one of the fragmentation mechanisms with minimal environmental impacts [38-42]. This method uses a pair of electrodes placed in the concrete and take advantage of liquid-electric effect or fuse explosion to produce mechanical action, and when high frequencies and pressures are applied, the temperature of the liquid or fuse sandwiched between the electrodes rises, and the thermal stress causes the concrete to crush into many small pieces. A report from the UK shows that a 100mm concrete cube can be peeled off by applying a pulse discharge of 5~80 $\mu$ s.

Compared with other demolition technologies, high-voltage pulse technology has the following advantages:

- It achieves the purpose of the separation of steel bars and concrete. Meanwhile, this method does not produce flying stones, dust, noise, and either generate toxic or harmful substances.
- It provide effective means for demolition of reinforced concrete structures in town populated environment.
- The demolition process can be controlled by regulating the discharge energy, and it is easily controllable.
- Using high pressure pulse to dismantle concrete has directionality, which can effectively use resources and improve energy utilization efficiency.
- It can crack or break the concrete in some occasions where the conventional demolition methods cannot be realized.

But the high-voltage pulse technology is also pointed out some problems: It uses expensive equipment, high working voltage, bulky generator, and it is unfavorable handling. The electrodes are serious ablated, and the safety and insulation problems of the equipment do not get adequate attention, which have limited the popularization and application of this technology. Besides, Holes need to be drilled to insert electrodes. The analysis results show that the working voltage should be reduced reasonably, and the safety and insulation of the equipment should be improved. It is advantageous to miniaturize the device and enhance its portability with a small single discharge energy, and to improve the discharge frequency and prolong the service life of the electrode. Which should be urgent problems to be solved in the future.

In order to facilitate the recycling and utilization of resources, Bluhm et al [43,44] from Karlsruhe Research Center developed a semi-industrial prototype for dismantling concrete materials. The pulse power supply of this prototype is Marx generator. The working voltage is 350 kV and the working frequency is 10 Hz.



The processing capacity of the prototype is 1000kg/h. Concrete blocks can be recycled after being broken [45] as shown in Figure 1.

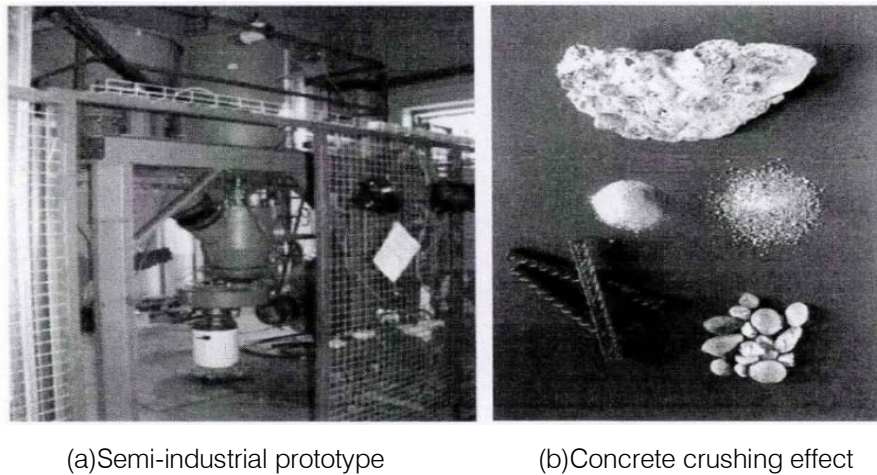

Figure 1: Semi-industrial prototype and crushing effect drawing for dismantling concrete [45]

#### d) Resonance Demolition Method

Institute of Earthquake Prevention and Disaster Reduction of Lanzhou University in China uses the resonance demolition method [46] to dismantle concrete structures. Firstly, a resonator is installed in the wall removed to measure its natural vibration frequency, and then the resonator is used to make wall vibration. When the frequency of loading achieves consistently with that of the wall, the wall is broken and fell off because of the resonance.

The resonance demolition method has great advantages over the traditional demolition methods:

- It does not produce dust or noise, because the natural vibration frequency of the wall is not within the range that can be distinguished by human ears;
- It is economical, green and safe, and it can make full use of the energy released by the resonator, that is, the energy utilization efficiency reaches the highest [3].
- This method can reduce the impact of harmful gases on the environment.
- The resonance demolition method is conducive to the recovery of some resources, which is up to the requirements of sustainable development strategy.

Up to now, this method is still in the experimental stage of development. The failure problems of uncertain vibration structure systems have followed two paths. One is failure research on the basis of the responses (displacement, stress, etc.) of forced vibration. The other is failure research on the basis of the relation between natural frequency and forcing frequency of vibration systems at resonance and non resonance [47]. Which needs a lot of improvement. Furthermore, if the resonance demolition method is

used to dismantle the wall, the wall can only be dismantled in blocks, and the erecting of the resonator is more troublesome. Reinforced concrete column and beam cannot be removed by resonance demolition method, which can only remove a small number of non-load-bearing or load-bearing structure. Thus, there are many limitations in using resonance demolition method.

#### e) Cut & down construction method

Cut & down construction method is also known as Kashima construction method, which is an advanced and sustainable way of demolishing high-rise buildings. Its basic idea is to dismantle concrete structure from the bottom of the building to its top. Firstly, scaffolding and sound insulation panels are built around the first floor of the building, and the other components are removed except for load-bearing columns of the first floor. And then some large-tonnage jacks are used to replace the columns of the first floor. The above operation is repeated again and again, and the concrete structures are dismantled by lowering the storey to remove it.

The cut & down construction method has many advantages:

- It can be operated in enclosed construction environment, so it is very good to avoid the generation of dust and reduce the construction noise and vibration.
- There is no damage to the surrounding buildings.
- There will not be the phenomenon that waste is thrown down from height, because construction is operated on the ground.
- The security is higher, Because it is different with other methods to dismantle concrete structure from the top of building. The ground floor of the building is used to establish a construction area, so the

demolition of the high-rise building just needs to be completed on the ground. And there is no need to move the personnel up and down,

- The construction progress is more eco-friendly [2], and the construction period can be shortened, because demolition operations near the ground are efficient.
- CO<sub>2</sub> emission is reduced, because more than half of CO<sub>2</sub> emissions come from the fuel used by machines in the demolition process, and this method can improve the construction efficiency and reduce 8.5%CO<sub>2</sub> emissions.
- The decoration materials recovery rate is up to 93%. Because this method is used to dismantle concrete structures floor by floor, and decoration is deconstructed and materials are classified to recycle.

Obviously, in the demolition of high-rise and super-high-rise buildings, this method has advantages in environmental protection and shorter construction period. In contrast, the conventional demolition method uses a tower crane to lift heavy machinery that is used to cut columns and beams up to the roof, and then starts from the top floor and dismantles them from top to bottom. Scaffolding must be erected around the perimeter of the building and measures must be taken to prevent noise and dust from intruding on the surrounding area. But the cut & down construction method is only carried out near the ground, which is easy to conduct sound insulation around the building. Because this method does not make a lot of noise, it is especially effective in areas with lots of super high-rise buildings nearby. However, the cut & down construction method has some disadvantages: (1) It needs large tonnage multi-point hydraulic synchronous jacks; (2) The operator must have proven experience and skill for operating the jacks [48].

A case study is the Prince Hotel of Akasaka in Japan with 138.9m height, which was once an iconic building in Tokyo. The hotel was removed from the bottom and supported the floor by jack in 2012. Every two floors was a unit, and the building was dismantled from low to high floor by floor. After half a year, the building was finally silent razed to the ground. Since most of the work was done inside the building, there was no sign of construction outside, but only the building was saw to sink into the ground floor by floor. It can significantly reduce dust and noise, and there was no damage the building around the hotel. In addition, two office buildings with 57.9m and 69.1m height and the 108m high Resona Maruha building were dismantled by cut & down construction method. According to calculation, it would take 9 months to demolish Resona Maruha building by using the traditional construction method, while it only took 6.5 months to complete the

construction by using the cutting construction method, including the construction of the core wall, Which can be shortened by 2.5 months.

#### f) *Drilled core demolition technology*

Drilled core demolition technology is appropriate for the elements of reinforced concrete structure with relatively dense steel bars. The coring drill can avoid tension bars and stirrup bars, and drill the support elements vertically or horizontally through the gap between the rebars. After the drilling is completed, the main bars will be cut off with a cutting machine, and finally the sections after cutting will be lifted by a crane [11].

This method has some advantages:

- It combines the characteristics of high safety of manual demolition of concrete support and fast mechanical crushing of concrete support.
- It can simultaneous operate by several coring drill and greatly save the construction period.
- It has simple working procedure, easy access to use machinery and low cost.
- This method has high construction accuracy, high speed and no dust pollution. The concrete surface is smooth, and it is mainly applicable to the demolition of reinforced concrete support elements.
- Vacuum disc drill can firmly adsorb on the flat building, no need for other fixed devices, so the building surface is not damaged at all.

However, the drilled core method has some shortcomings: (1) The construction efficiency of this method is still relatively low. (2) The frame set up will take up a large amount of construction time.

A case study is that an inter-city railway project. It is all underground engineering, and 2 ~ 4 internal supports are set vertically in the foundation pit. Among which the first one is reinforced concrete internal supports, and the rest are steel tube supports. There are 750 reinforced concrete supports need to be removed. In the demolition site, a type 100A or 160A drill (5 ~ 10cm in diameter and 80cm in length) is used to drill vertical and horizontal holes in the gap between tensile and stirring bars for the support beam. After drilling, a cutting machine is used to remove the main bars. Then the cutting work is finished. Finally, the supports are lifted away by gantry crane from the foundation pit. The foundation pit is safe and reliable. The concrete support beam can be lifted away from the foundation pit, which greatly improves the work efficiency and saves the time limit [49].

#### g) *Intelligent robot demolition technology*

Intelligent robot is mainly used in manufacturing industry at the beginning. With the continuous maturity of robot technology, it is gradually applied in mechanical

demolition of construction industry. In the situation of hazardous or potentially dangerous situations, consideration should be given to the use of remotely controlled machines and robotic devices. The operator can be removed from the dangers of working in a confined or hazardous area. The machines can be controlled by digital signalling system transmitted via cable or radio.

The advantages of intelligent demolition robot over general mechanical demolition are:

- It can engage in high-risk demolition operations and reduce casualties.
- It can greatly improve the efficiency of demolition and reduce dust pollution caused by demolition.
- Minimum labor results in reduced cost, more energy efficient, more reliable [50].
- It is suitable for places with limited space

Foreign manufacturers of dismantling robots mainly include BROKK company of Sweden, TOPTec company of Germany and F1NMAC company of Finland [51]. After continuous improvement and development, the demolition robot developed by Sweden BROKK company is in the international leading position in various technologies. It is the largest supplier of demolition robot at present, and its products are sold all over the world. For example, one of the robots that used remote demolition technology is the ISO Model from BROKK. This robot is designed for using in the regeneration and renewal of urban, commercial and industrial environments. It also had been designed to better suit accessories, particularly heavier tools up to 230kg and either a 15kW or 18.5kW electric motor to drive the machines. Its standard weight exclude accessories are 1,900kg with a basic work area radius of 4550mm, which can be increased depending on attachments [52]. In addition, intelligent robot can be combined with water jetting, thermal lance and other dangerous demolition methods.

A case study is a high-velocity, high-pressure water nozzle of hydro demolition equipment, which was housed in a robot that moved across a concrete slab in the U.S. in the mid-1980s. The nozzle(s) moved back and forth on a transverse track allowing for a full width movement of about 6 ft[53]. The microprocessor-controlled hydro-demolisher from FIP Industriale can be programmed to cut to any depth, removing as little or as much concrete as needed. The hydro demolisher removes varying amounts of concrete by adjusting how quickly the nozzle moves and how fast the mobile unit moves forward [54, 55]. The Conjet concrete removal system from Atlas Copco also consists of a high-pressure nozzle (117,215 kN/m<sup>2</sup> or 17,000 psi) housed in a tire-mounted, microprocessor controlled robot.

The usage or application areas for demolition robot are: (1) Dangerous environments for operations

e.g. unsafe structures or danger to personnel; (2) Internal demolition e.g. Concrete floors in multistorey structure; (3) Pre-weakening of structures for demolition by explosives; (4) Confined areas and where there is danger of collapse or unstable structures; (5) Nuclear waste-contaminated environments.

## VI. SAFETY ISSUES IN CONCRETE STRUCTURE DEMOLITION

Whatever the demolition method or the size of the job is chosen, safety issues, including protecting workers and the public, protecting adjacent structures, and protecting existing utilities, are most important factors needing to be taken into account.

### a) *Protecting workers and public*

To ensure adequate protection to the workers and the public, the contractor should do the following:

- Develop proper demolition plans including detailed engineering calculations showing load determinations and structural analyses. Which should also show the demolition sequence, staging, services, transport route and access, equipment location, restraints and false work for structural stability, and hazard materials.
- Develop a comprehensive "Code of Safe Practice" that includes a plan for the use of personal protective equipment (including hard hats, gloves, goggles, construction boots, tie-off, protective clothing, seat belts and canopies).
- Remove hazard materials such as asbestos and polychlorinated biphenyls (PCBs) must be done in accordance with regulations set by the Occupational Safety and Health Act (OSHA) and the Environmental Protection Agency (EPA) to ensure the workers will not be harmed by these extremely dangerous materials.
- Develop a maintenance plan for keeping all pieces of equipment on the job in good working condition for the duration of the project, and rehearse the demolition process to ensure tools are safe and effective.
- Develop a dust control plan (such as using water sprays).
- Develop a plan to prevent debris from injuring the workers and public (such as using debris nets), or sort and process the recyclable materials on site.
- Develop a plan to protect the public from noise (such as monitoring work-hour schedules and noise levels), or use green demolition technology.

### b) *Protecting public facilities*

Underground and overhead, two types of public facilities may exist in the vicinity of a demolition project. Underground utilities may include gas mains, sewer

lines, and water pipes. Overhead utilities may include the electric lines, power and telephone lines.

To protect underground facilities, some of the measures can be taken:

- High-pressure water lines should be shut down within the demolition zone.
- Locate and mark warning signs within the gas mains and sewer lines zone.
- Steel plates may also be used as covers to protect against impact.
- Debris piles should be built on top of such lines to provide a cushion against impact from falling objects.
- No large demolition waste should be allowed to drop.

To protect overhead facilities, the contractor should request government approval and work closely with the responsible agency to arrange for a temporary shutdown and removal of those lines in the immediate vicinity of the portion of the structure being demolished until the operation is complete. Accurate schedules should always be sent to utility agencies to minimize service disruption and inconvenience to the public.

#### c) *Protecting Adjacent Structures*

One of the major challenges during a concrete structure demolition project is how to protect adjacent structures. Some of these structures may be so close to the structure that careful planning becomes extremely important to avoid damage or even collapse of such structures. A number of measures can be taken to ensure the protection of adjacent structures are as follows:

- All possible loads on concrete structure should be analyzed to establish a safe loading range before demolition starts and to ensure that floor slabs do not become overloaded by debris and/or heavy pieces of equipment.
- All load-bearing beams and columns at a lower level should not be cut or removed until demolition at the upper level is completed. Caution should be exercised in removing when they tie into party walls. Beams and columns should always be well secured with wire rope or chains when they are cut.
- All columns should be restrained by temporary column-restraining steel structures and/or cables to prevent the premature collapse of a column in the direction of adjacent structures.
- A vibration monitoring program may also be established to prevent vibrations from exceeding the maximum limits for adjacent structures.

## VII. SUMMARY AND CONCLUSIONS

Concrete structure demolition is a complicated process that needs careful planning and management.

More emphasis should be placed on selecting rational demolition methods and equipment to achieve a satisfactory outcome. A number of traditional and green demolition methods were described in the paper, providing a comprehensive literature review of how each method works and what type of projects it serves. Advantages and disadvantages of each method were contrasted. This paper then discussed safety issues for protecting workers and public in concrete structure demolition, and how a demolition engineering should be considered to provide a safe work environment.

By comparison, it is proved that green demolition methods have many irreplaceable advantages over traditional demolition methods: easy to control and recycle, no noise, no vibration, no dust, no explosive, lower hazards to workers, safety and environmental protection. Concrete structure demolition is becoming an increasingly important subject when dealing with building and transportation infrastructure rehabilitation and maintenance as more and more structures and bridges reach their design service life and become candidates for replacement, rehabilitation, and/or widening. It is the general trend to optimize the selection of suitable demolition technology and to develop innovative green and safe demolition technologies.

## ACKNOWLEDGMENTS

The work presented in this paper was partially funded by the National Key R&D Program of China through Harbin University of Science and Technology, Grant 2017YFC0806100. The support from NKRDP is gratefully acknowledged.

## REFERENCES RÉFÉRENCES REFERENCIAS

1. Liang G Y. Why are there short-lived buildings? *Environment*, 2015, 9, 16-18.
2. Hudgins H T. Demolition of concrete structures. *Concrete Construction*. 1987, 32(1), 24-31.
3. Abudayyeh O, Sawhney A, El-Bibany H, Buchanan D. Concrete bridge demolition methods and equipment. *Journal of Bridge Engineering*. 1998, 3(3), 117-125.
4. Brecher, A. Infrastructure: A national priority. *SWE*, 1995, 41(6), 14-16.
5. Gambatese J A. Controlled concrete demolition using expansive cracking agents. *Journal of Construction Engineering and Management*. 2003, 129(1): 98-104.
6. Abdullah A. Intelligent selection of demolition techniques. M.Sc. Thesis, M.Sc. Dissertation, Department of Civil and Building Engineering, Loughborough University, UK. 2003, 18-76.
7. Poon C S, Yu A T W, Ng L H. On-site sorting of construction and demolition waste in Hong Kong.



- Resources, Conservation and Recycling. 2001, 32(2), 157-172.
8. Fesseha T. Criteria for selection of demolition techniques. M.Sc. Thesis, M.Sc. Dissertation, Department of Civil and Building Engineering, Loughborough University, UK. 1999, 9-46.
  9. Kasai, Y., Rosseau, E. Lindsell, P. Outline of various demolition methods and their evaluation. RILEM International Symposium on Demolition and Reuse of Concrete and Masonry: Demolition Methods and Practice, Chapman and Hall, London. 1998.
  10. Buildings Department. Code of Practice for Demolition of Buildings, Hong Kong. 2004.
  11. Chen P H. The green dismantling technology of reinforced concrete supporting beam in deep foundation pit. Fujian Architecture and Construction. 2013, 183(9), 52-54.
  12. Campbell, Sr, R L, Army engineer waterways experiment Station vicksburg MS structures lab. A review of methods for concrete removal, Technical Report. 1982.
  13. Zhang Z J, Xiao L, Jiang Z L. Study on application of green static cutting technology in the demolition of overpass within urban core areas. Construction Technology. 2019, 48(4), 119-124.
  14. Yang G Z, Liu W J. Application of non-destructive drilling technology in sanyuanqiao rapid overhaul. Construction Technology. 2018, 47(7), 141-144.
  15. Manning D G. Removing concrete from bridges. Transportation Research Board National Research Council. 1991.
  16. Chacos, G P. Demolishing a post-tensioned parking garage. Concrete International, 1991, 13(10), 44-46.
  17. Chen B X, Deng M. Introduction of mechanical removing-building methods. Construction Technology. 2004, 33(6), 50-51.
  18. Tam C M, Tam V W Y, Tsui W S. Green construction assessment for environmental management in the construction industry of Hong Kong. International Journal of Project Management. 2004, 22(7), 563-571.
  19. Neitzel R L, Seixas N S, Ren K K. A review of crane safety in the construction industry. Applied Occupational and Environmental Hygiene. 2001, 16(12), 1106-1117.
  20. Halberstadt H. Demolition equipment, Motor books International. Osceola, WI. 1996, 3, 7-23.
  21. Helene L. Demolition: The art of demolition, dismantling, imploding, toppling and razing. Black Dog & Leventhal Pub, US, 2000. 15-27.
  22. Ma J J, Duan W D. Controlled demolition of building by applying combination of machinery and blasting. Architecture Technology. 2003, 34(6), 430-432.
  23. Anchar B B, A history of structural demolition in America, 28th Annual International Society of Explosives Engineers Conference in Las Vegas, Nevada on February 11th, 2002, I, 25-37.
  24. Clark C, Jambeck J, Townsend T. A review of construction and demolition debris regulations in the United States. Critical Reviews in Environmental Science and Technology. 2008, 36 (2), 141-186.
  25. Wang J, Ma J X. Hydraulic concrete and rock splitters. Construction Machinery, 2005, 12, 90-91.
  26. Sinitsyn D. Drilling-and-blasting method of demolition. Engineering Systems and Building Materials. 2018, 170, 1-6.
  27. Concrete Network. Concrete Demolition, Internet, ConcreteNetwork.com, <<http://www.concretenetwork.com/concrete/demolition/index.html>> [01/06/2001]
  28. Isobe D. An analysis code and a planning tool based on a key element index for controlled explosive demolition. International Journal of High-Rise Buildings. 2014, 3(4), 243-254.
  29. Roller H. Demolition of motorway bridges by blasting. Demolition and Reuse of Concrete and Masonry. Y. Kasal, ed., Chapman & Hall, Inc., New York, N.Y., 1988, 1, 385-394.
  30. Terpening, T B, Micheal I. Out with the old. Civil Engineering, ASCE. 1992, 62(9), 50-53.
  31. Shi J H. Preliminary discussion on green removal technology for reinforced concrete support. Building Construction. 2015, 37(5), 596-598.
  32. Kasai Y, Fujii T. Demolition and reuse of concrete and masonry, Concrete International: Design and Construction, 1989, 11(3), 24~25.
  33. Kasai Y. Demolition of concrete structures by heating. Concrete International: Design and Construction, 1989, 11(3), 33~37.
  34. Hinze J, Brown J. Properties of soundless chemical demolition agents. Journal of Construction Engineering and Management, ASCE, 1994, 120(4), 816-827.
  35. De Silva R V S, Gamage R P, Perera M S A. An alternative to conventional rock fragmentation methods using SCDA: A review. Energies 2016, 9(11), 958-989.
  36. De Silva R V S, Ranjitha P G, Perera M S A, Wu B, Rathnaweera T D. A modified, hydrophobic soundless cracking demolition agent for non-explosive demolition and fracturing applications. Process Safety and Environmental Protection. 2018, 119, 1-13.
  37. Natanzi A S, Laefer D F, Connolly L. Cold and moderate ambient temperatures effects on expansive pressure development in soundless chemical demolition agents. Construction and Building Materials 2016, 110(1), 117-127.
  38. Andres, U. Electrical disintegration of rock. Mineral Processing and Extractive Metallurgy Review. 1995, 14, 87-110.
  39. Andres, U. Development and prospects of mineral liberation by electrical pulses. International Journal of Mineral Processing. 2010, 97, 31-38.



40. Hirotoishi I, Igor V L, Hidenori A, Izumi N. Pulsed electric breakdown and destruction of granite. *Japanese Journal of Applied Physics*. 1999, 38, 6502-6505.
41. Kuznetsov Y I, Vazhov V F, Zhurkov M Y. Electrical breakdown of solid dielectrics and rocks on the trailing edge of a voltage pulse. *Russian Physics Journal*. 2011, 54, 410-415.
42. Lisitsyn I, Inoue H, Nishizawa I, Katsuki S, Akiyama H. Breakdown and destruction of heterogeneous solid dielectrics by high voltage pulses. *Journal of Applied Physics*. 1998, 84, 6262-6267.
43. Bluhm H. Pulsed power systems principles and applications, Burlin: Springer, 2006, 1, 281-305.
44. Bluhm H, Frey W, Giese H, Hoppe P, Schultheiss C, Strassner R. Application of pulsed HV discharges to material fragmentation and recycling. *Dielectrics and Electrical Insulation, IEEE*, 2000, 7(5), 625-636.
45. Zhang Z C. Rock fragmentation by pulsed high voltage discharge and drilling equipment development. Zhejiang University. Hangzhou, 2013, 18-25.
46. Yang C. New ideas of dismantling the structure of buildings based on Resonance Theory. *Science and Technology Innovation Herald*. 2014, 11, 43-44.
47. Zhou Z. Research on construction methods of mechanical dismantling. *Shanxi Architecture*. 2016, 20, 81-83.
48. Hao C B, Su N. On sustainable strategies in the process of building demolition. *Chinese and Overseas Architecture*. 2015, 2, 114-116.
49. Li J, Yong Y, Pan F. New technology for dismantling of concrete waling of deep foundation pits. *Tunnel Construction*. 2013, 33(4), 319-322.
50. Derlukiewicz D, Ptak M, Kozidek S. Proactive failure prevention by human- machine interface in remote-controlled demolition. *New Advances in Information Systems and Technologies*, 2016, 445,711-720.
51. Shen J J, Liu L, Tang H C. Simulation and analysis on vibratory hydraulic system on tandem rollers using AMEsim and ADAMS. *Chinese Journal of Construction Machinery*. 2009,7(1),31-35
52. Tatten J J. Demolition and dismantling, *The Journal of The National Federation of Demolition Contractors*, 2000, 1, 413-420.
53. Bradley, J. F. Hydro-demolition speeds bridge deck rehabilitation. *Concrete International*, 1988, 10(4), 52-53.
54. Bradley, J. F. Hydrodemolition for restoration. *Concrete International*, 1987, 9(8), 59-61.
55. Yun K K, Lee K R, Han S Y, Kim Y G, Kwon S A. Rehabilitation of marine concrete structure with under-water hydro demolition and sprayed concrete. *Matec Web of Conferences*. 2018, 199,1-4.



GLOBAL JOURNAL OF RESEARCHES IN ENGINEERING: E  
CIVIL AND STRUCTURAL ENGINEERING  
Volume 19 Issue 4 Version 1.0 Year 2019  
Type: Double Blind Peer Reviewed International Research Journal  
Publisher: Global Journals  
Online ISSN: 2249-4596 & Print ISSN: 0975-5861

# Estimation of Uplift Capacity of Horizontal Plate Anchor in Sand

By Prof. D. M. Dewaikar & Prof.V. B. Deshmukh

**Abstract-** In this paper a detailed analysis of breakout resistance of a horizontally laid anchor plate in sandy soil is presented. To compute the distribution of soil reactive pressure on the failure surface, Kötter's equation is employed. The failure surface is assumed to be in the form of a cone. An analytical expression for the breakout resistance is derived. Results are reported in terms of the breakout factors and net breakout resistance. A comparison is made with the available experimental data and theoretical solutions.

**Keywords:** *kötter's equation, horizontal circular anchor plate, sand, net breakout resistance, breakout factor.*

**GJRE-E Classification:** FOR Code: 290899



*Strictly as per the compliance and regulations of:*



© 2019. Prof. D. M. Dewaikar & Prof.V. B. Deshmukh. This is a research/review paper, distributed under the terms of the Creative Commons Attribution-Noncommercial 3.0 Unported License (<http://creativecommons.org/licenses/by-nc/3.0/>), permitting all non commercial use, distribution, and reproduction in any medium, provided the original work is properly cited.

# Estimation of Uplift Capacity of Horizontal Plate Anchor in Sand

Prof. D. M. Dewaikar<sup>α</sup> & Prof.V. B. Deshmukh<sup>σ</sup>

**Abstract-** In this paper, a detailed analysis of breakout resistance of a horizontally laid anchor plate in sandy soil is presented. To compute the distribution of soil reactive pressure on the failure surface, Kötter's equation is employed. The failure surface is assumed to be in the form of a cone. An analytical expression for the breakout resistance is derived. Results are reported in terms of the breakout factors and net breakout resistance. A comparison is made with the available experimental data and theoretical solutions.

**Keywords:** Kötter's equation, horizontal circular anchor plate, sand, net breakout resistance, breakout factor.

## I. INTRODUCTION

The shapes of earth anchors are square, circular or rectangular and generally they are employed as foundation elements for structures requiring resistance against breakout i.e., transmission towers, sheet pile walls and offshore floating structures. This requires an analysis of behaviour of the anchors.

Several researchers (Mors, 1959; Balla, 1961; Baker and Konder, 1966; Meyerhof and Adams, 1968; Vesic, 1971; Clemence and Veesaert, 1977; Sutherland

$$P_{un} = H^3 \gamma \left[ F_1 \left( \phi, \frac{H}{D} \right) + F_3 \left( \phi, \frac{H}{D} \right) \right] \quad (1)$$

where,  $D$  is the diameter of circular anchor plate,  $H$  is the height of circular anchor,  $\gamma$  is the soil unit weight and  $F_1(\phi, H/D)$ ,  $F_3(\phi, H/D)$  are the functions developed by Balla (1961).

Balla's (1961) analysis showed a good agreement for the dense sand up-to the embedment ratio of 5. But, in respect to anchors laid in loose and medium sand, the analysis overestimated the net breakout resistance. For embedment ratio greater than 5 even in dense sand, the analysis overestimated the breakout resistance due to deep anchor effects wherein the failure zone did not reach the ground level.

Baker and Konder (1966) conducted several laboratory model tests and used dimensional analysis to predict the ultimate uplift capacity,  $P_u$  as given by the following expressions.

For shallow circular anchors

*Author α:* Retired Professor, Department of Civil Engineering, Indian Institute of Technology Bombay, Powai, Mumbai, Maharashtra, India, 400076. e-mail: profdmde@gmail.com

*Author σ:* Associate Professor, V.J.T.I., Mumbai, Maharashtra, India, 400019. e-mail: vbdeshmukh@st.vjti.ac.in

et al., 1982; Saeedy, 1987; Murray and Geddes, 1987; Ghaly et al., 1991; Tom, 2012) analysed the breakout resistance of earth anchors using limit equilibrium method. Tagaya et al. (1988) introduced the theoretical formulae for the computation of the anchor pullout resistance based on elastoplastic finite element method, whereas analyses presented by Merifield and Sloan (2006) and Kumar and Kouzer (2008), Tang et al. (2014), Hao et al. (2014) and Bhattacharya and Kumar (2016) were based on the limit analysis coupled with finite element method.

In respect to a dense soil, Balla (1961) studied model and field results and found that, for circular anchors which are shallow laid, the failure surface was closely approximated to an arc of a circle. From theoretical considerations, the angle of failure surface with the horizontal was taken as  $45^\circ - \phi/2$ . The net breakout resistance,  $P_{un}$  which is the summation of soil weight contained in the failure zone and resistance to shearing developed on the failure surface was calculated as

$$P_u = C_1 H D^3 r + C_2 H^3 \gamma \quad (2)$$

For deep circular anchors

$$P_u = 170 D^3 \gamma + C_3 D^2 t r + C_4 H D + \gamma \quad (3)$$

where,  $r$  and  $t$  are radius and the thickness of anchor plate respectively and  $H$  is the depth of embedment.  $C_1$ ,  $C_2$ ,  $C_3$  and  $C_4$  are the constants which are functions of angle of soil internal friction and relative density of compaction. For shallow anchors, the model test results of Baker and Konder (1966) agreed well with the predictions based on Balla's (1961) theory.

Meyerhof and Adams (1968) reported a semi-theoretical expression for breakout resistance on the basis of laboratory tests data. For the actual failure surface, simplified geometry was assumed. The failure surface makes an angle,  $\alpha$  with the horizontal in the range,  $90^\circ - \phi/3$  to  $90^\circ - 2\phi/3$ . An average value of  $90^\circ - \phi/2$  was considered. With the force equilibrium in vertical direction, the net breakout resistance,  $P_{un}$  was estimated as

$$P_{un} = W + \frac{\pi}{2} S_F \gamma H^2 K_u \tan \phi \quad (4)$$

where,  $W$  is the weight of cylindrical soil mass above the circular anchor and  $S_F$  is the shape factor. The breakout coefficient,  $K_u$  depends on soil friction angle,  $\phi$  and was taken equal to 0.95 for  $\phi$  varying from  $30^\circ$  to  $48^\circ$ . The net breakout resistance,  $P_{un}$  was expressed as

$$P_{un} = F_q \gamma AH \quad (5)$$

The breakout factor,  $F_q$  is given as

$$F_q = 1 + 2 \left[ 1 + m \left( \frac{H}{D} \right) \right] K_u \left( \frac{H}{D} \right) \tan \phi \quad (6)$$

Graphs or tables are used to obtain the coefficient,  $m$ .

Vesic (1971) analysed the case of an explosive point charge for the expansion of a spherical cavity located close to the surface of a semi-infinite, homogeneous and isotropic ground. At the ground

$$F_q = \frac{P_{un}}{\gamma AH} \quad (8)$$

Or

$$F_q = 4K_0 (\tan \phi) \cos^2 \left( \frac{\phi}{2} \right) \left( \frac{H}{D} \right)^2 \left[ \frac{0.5}{\left( \frac{H}{D} \right)} + \frac{\tan \frac{\phi}{2}}{3} \right] + \left( 4 + 8 \left( \frac{H}{D} \right) \tan \left( \frac{\phi}{2} \right) + 5.33 \left( \frac{H}{D} \right)^2 \tan^2 \left( \frac{\phi}{2} \right) \right) \quad (9)$$

where,  $K_0$  is the coefficient of lateral earth pressure at rest.

Murray and Geddes (1987) have reported the solutions with both limit equilibrium and limit analyses and made a comparison of the solutions with

$$\frac{P_u}{\gamma AH} = 1 + 2 \frac{H}{D} \left( \sin \phi + \sin \frac{\phi}{2} \right) \left( 1 + \frac{2}{3} \frac{H}{D} \tan \frac{\phi}{2} (2 - \sin \phi) \right) \quad (10)$$

In the above equation,  $A$  is the area of circular anchor.

With upper bound limit solution, the breakout resistance was expressed by the following equation.

$$\frac{P_u}{\gamma AH} = 1 + 2 \frac{H}{D} \tan \phi \quad (11)$$

Saeedy (1987) estimated the uplift capacity of circular plate anchors embedded in sand with the assumption of a failure surface as an arc of a logarithmic spiral. The effect of deep condition and compaction during the uplift were considered in this analysis. To account for these conditions, the uplift capacity was expressed as

$$P_u = (F_q \gamma AH) \mu \quad (12)$$

level, the failure surfaces made an angle of  $(45^\circ - \phi/2)$ . case of a circular anchor embedded in sand, the breakout pressure,  $q_u$  was computed as

$$q_u = \gamma H A F_q \quad (7)$$

where,  $A$  is the area of circular anchor and  $F_q$  is the breakout factor. The values of  $F_q$  are computed for  $\phi$  varying in the range,  $0^\circ$  to  $50^\circ$  along with embedment ratios in the range, 0.5 to 8.

Clemence and Veesaert (1977) studied the results of laboratory experiments and made an approximation of the observed failure surface to an inverted truncated cone with an apex angle of  $\phi/2$ , going upwards from the anchor base. The breakout resistance includes the weight of soil within this cone and the shearing resistance developed along the failure surface. For shallow laid circular anchors, the net breakout resistance,  $P_{un}$  was estimated in terms of the breakout factor,  $F_q$  as given by the following expressions.

experimental results for a circular anchor. With the limit equilibrium analysis, the ultimate breakout resistance,  $P_u$  was expressed by the following equation.

where,  $\mu$  is the compaction factor which is the function of relative density of compaction.

Semi-empirical relationships are also available to estimate the breakout resistance of anchors in sand. This refers to the field and/or model testing on horizontal circular anchors or belled piles by Balla (1961), Sutherland (1965) and Baker and Konder (1966), Mors (1959), Giffels et al. (1960), Turner (1962), Ireland (1963), Mariupol'skii (1965), Kananyan (1966), Adams and Hayes (1967) and Sakai et al. (2007). A number of these studies were primarily concerned with testing foundations for transmission towers (Mors, 1959; Balla, 1961; Turner, 1962 and Ireland, 1963).

In the present study, a total of seven experimental results (Balla, 1961; Baker and Konder, 1966; Bemben and Kupferman, 1975; Ovesen, 1981; Sutherland et al., 1982; Illampurathi et al., 2002; Murray

and Geddes, 1987) and two field test results (Sutherland et al., 1982; Tucker, 1987) are referred for comparison.

## II. PROPOSED ANALYSIS METHOD

Kötter's (1903) equation is used to compute the vertical soil reaction,  $R_v$  along the failure surface. This equation which is valid for the plane strain condition was employed for the analysis of a retaining wall by Dewaikar and Halkude (2002a), for the stability analysis of open cuts in soil by Dewaikar and Halkude (2002b), for the computation of bearing capacity factor,  $N_\gamma$  by Dewaikar and Mohapatro (2003), analysis of rectangular and square anchors in cohesionless soil by Deshmukh et al. (2010) and uplift capacity of pile anchors in cohesion less soil by Deshmukh et al. (2010). On integration along a plane or a curved failure surface, this equation gives the soil reactive pressure distribution and with further integration, it yields the resultant soil reaction on the failure surface.

b) Soil Reaction on the Plane Failure Surface (Refer Fig.1)

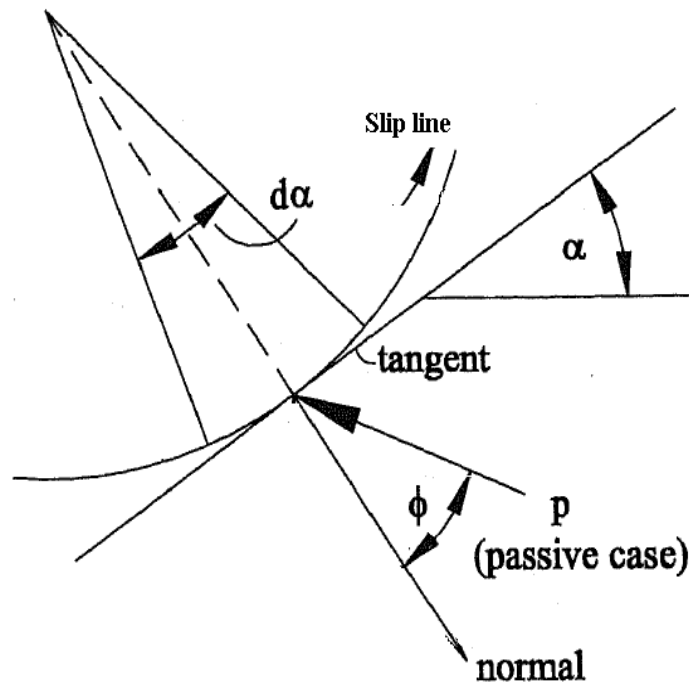

Figure 1: Kötter's (1903) equation for a curved failure surface

For a soil medium cohesionless in nature and in the passive state of equilibrium, Kötter's (1903) equation for a curved failure surface for the plane strain condition is given as

$$\frac{dp}{ds} + 2p \tan \phi \frac{d\alpha}{ds} = \gamma \sin(\alpha + \phi) \quad (14)$$

where,  $dp$  is the elemental soil reaction pressure along the failure surface,  $ds$  is the elemental failure surface length,  $\phi$  is the soil friction angle,  $d\alpha$  is the elemental

The analysis is confined to embedment ratios,  $\lambda = H/D \leq 12$ . The failure surface geometry corresponds to the frustum of a cone, making an angle  $\alpha$  with the horizontal and meeting the ground level.

To compute the vertical soil reaction,  $R_v$  acting on the failure surface, Kötter's (1903) equation is integrated.

The breakout resistance is finally obtained with the summation of  $R_v$  and total weight,  $W$  of soil mass contained in the failure zone.

a) Failure Surface Geometry

The angle,  $\alpha$  is a function of soil friction angle,  $\phi$  and according to Meyerhof and Adams (1968),  $\alpha$  varies in the range,  $(90^\circ - \phi/3)$  to  $(90^\circ - 2\phi/3)$  with an average value of  $(90^\circ - \phi/2)$ . Based on this observation and some initial trials, the following expression for  $\alpha$  is chosen for the analysis.

$$\alpha = 90 - 2\phi/3 \quad (13)$$



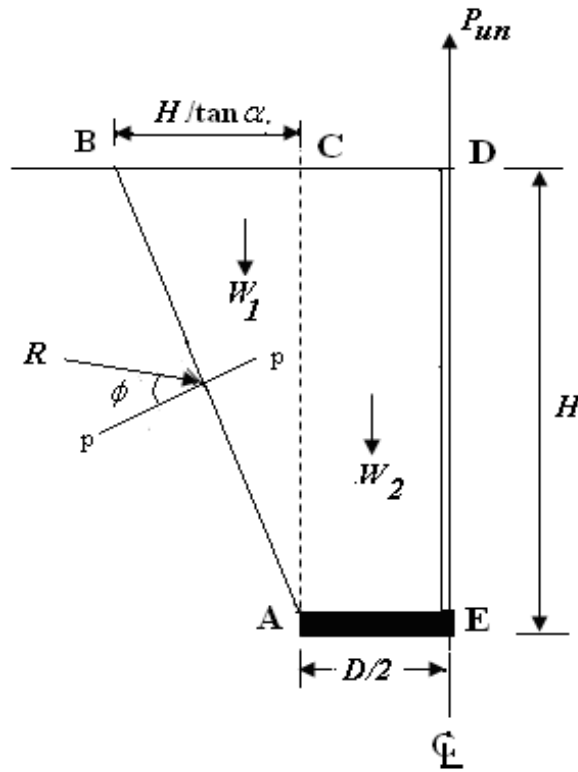

Figure 2: Forces on a failure wedge under plane strain condition

In the force diagram as shown in Fig. 2, AB is a part of the failure wedge, ABC in the case of a strip anchor under plane strain condition. The forces that come into play are the passive thrust  $P_p$ , weight  $W_1$  of failure wedge ABC and soil reactive force  $R$  on the failure plane AB. In respect to a plane failure surface,  $d\alpha/ds$  becomes equal to zero and Eq. (14) takes the following form.

$$\frac{dp}{ds} = \gamma \sin(\alpha + \phi) \quad (15)$$

Integration of Eq. (15) gives,

$$p = \gamma \sin(\alpha + \phi)s + C_1 \quad (16)$$

Eq. (16) gives the soil reactive pressure distribution on failure plane, AB, and  $s$  is the distance measured from point B (Fig. 2). The integration constant,  $C_1$  in Eq. (16) is obtained from the condition that, pressure  $p$  has zero value at point B, corresponding to  $s = 0$ . Using this condition,  $C_1$  becomes zero and Eq.(16) finally becomes

$$p = \gamma \sin(\alpha + \phi)s \quad (17)$$

c) Soil Reaction for the Axi-symmetric Condition

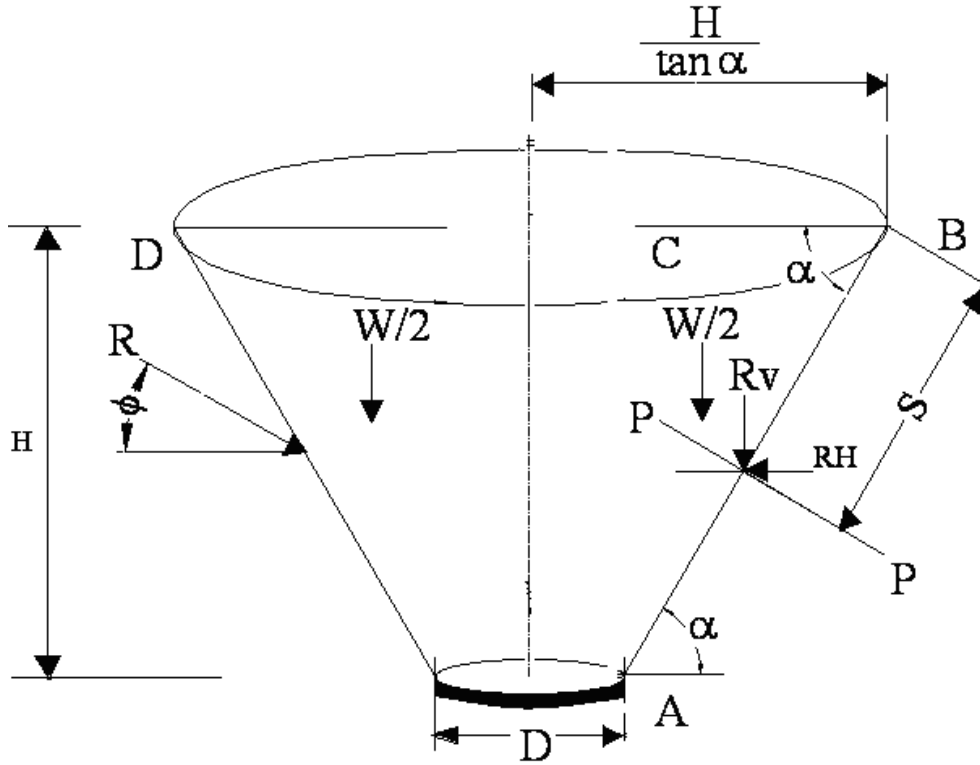

Figure 3a: Free-body diagram for the horizontal circular plate anchor in the axi-symmetric condition

At the instant of breakout of horizontal circular plate anchor in a cohesionless soil medium, failure surface in the form of a conical frustum is developed as

shown in Fig. 3a. The breakout force is countered by the vertical component,  $R_v$  of the resultant soil reactive force and the weight,  $W$  of soil.

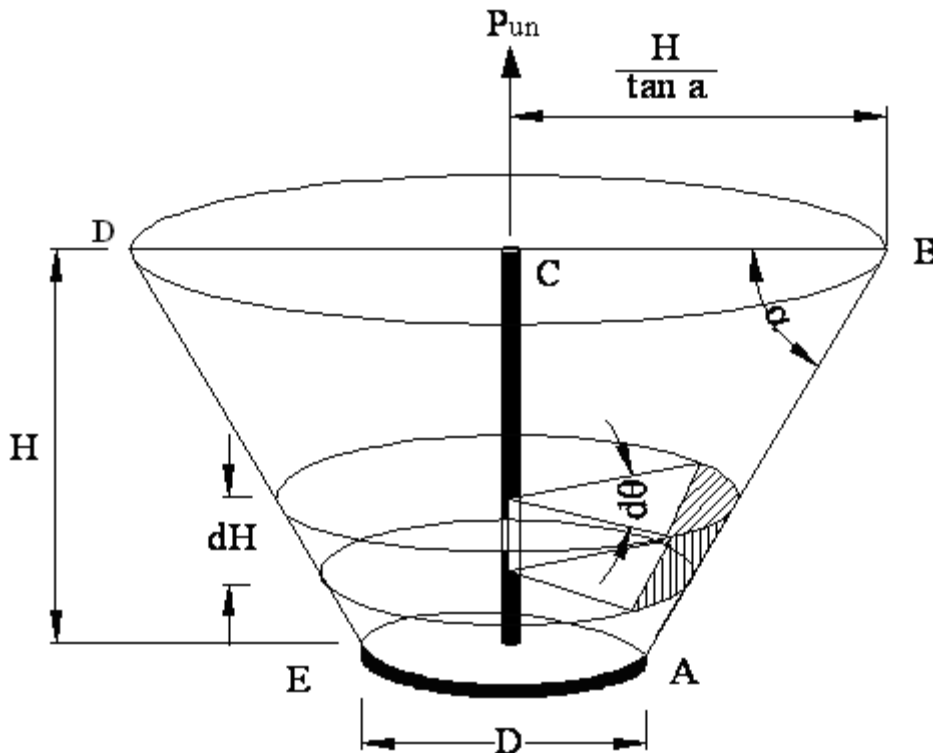

Figure 3b: Axi-symmetric solid body of revolution

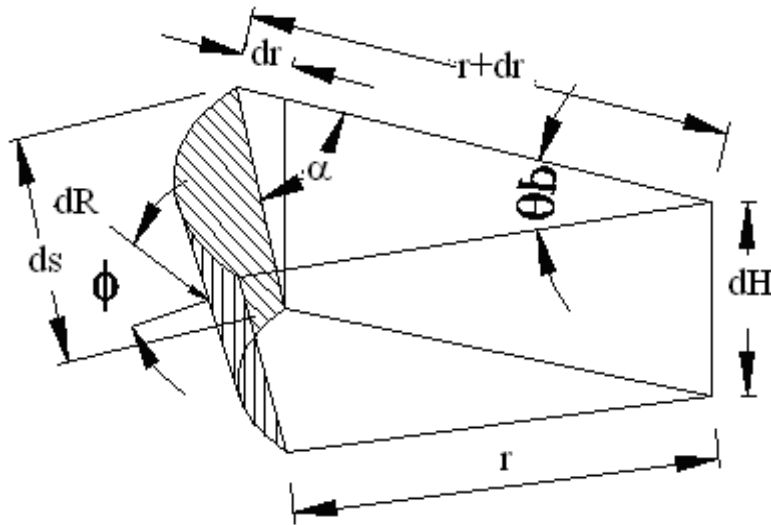

Figure 3c: Elemental forces

In the failure wedge shown in Figs. 3b and 3c, an element making an angle  $d\theta$  with radius  $r$  is referred. With  $dp$  as the elemental reactive pressure,  $dR$  becomes the elemental soil reaction on the element area ( $r \cdot d\theta$ ).

$ds$ ). The height of this element is  $dH$ , with a slanted height  $ds$  and it is located at a distance,  $s$  as measured from the ground surface.

The elemental soil reaction,  $dR$  is then expressed as

$$dR = dP \cdot dA \tag{18}$$

where,  $dA = r \, d\theta \, ds$

From Fig.3c,  $ds = dr / \cos\alpha$

Therefore,

$$dA = r \, d\theta \frac{dr}{\cos\alpha} \tag{19}$$

Substituting Eqs. (18) and (19) into Eq. (17), the elemental soil reaction,  $dR$  is obtained as

$$dR = r \, d\theta \frac{dr}{\cos\alpha} \gamma \sin(\alpha + \phi) s \tag{20}$$

From Fig. 3a, the distance,  $s$  is obtained as

$$s = \frac{\left[ \frac{H}{\tan\alpha} + \frac{D}{2} \right] - \left( r + \frac{dr}{2} \right)}{\cos\alpha} \tag{21}$$

Substituting Eq. (21) into Eq. (20), the elemental soil reaction,  $dR$  is rewritten as

$$dR = \frac{\gamma \sin(\alpha + \phi)}{\cos^2\alpha} \left[ \left( \frac{H}{\tan\alpha} + \frac{D}{2} \right) - \left( r + \frac{dr}{2} \right) \right] r \, dr \, d\theta \tag{22}$$

Or,



$$dR = \frac{\gamma \sin(\alpha + \phi)}{\cos^2 \alpha} \left[ \left( \frac{H}{\tan \alpha} + \frac{D}{2} \right) r dr - \left( \frac{2r^2 dr + r dr^2}{2} \right) \right] d\theta \quad (23)$$

With  $dr^2 \cong 0$ , Eq. (23) becomes

$$dR = \frac{\gamma \sin(\alpha + \phi)}{\cos^2 \alpha} \left[ \left( \frac{H}{\tan \alpha} + \frac{D}{2} \right) r dr - r^2 dr \right] d\theta \quad (24)$$

The elemental vertical component,  $dR_v$  is then obtained as

$$dR_v = \frac{\gamma \sin(\alpha + \phi)}{\cos^2 \alpha} \left[ \left( \frac{H}{\tan \alpha} + \frac{D}{2} \right) r dr - r^2 dr \right] \cos(\alpha + \phi) d\theta \quad (25)$$

After performing integration ( $r$  varying from  $D/2$  to  $H/\tan \alpha$  and  $\theta$  varying from 0 to  $2\pi$ ), vertical soil reaction component,  $R_v$  is computed as

$$R_v = \frac{\pi \gamma \sin(\alpha + \phi) \cos(\alpha + \phi)}{6 \cos^2 \phi} \left[ \left( \frac{H}{\tan \alpha} + \frac{D}{2} \right) + \frac{D^2}{4} \left( D - 3 \left( \frac{H}{\tan \alpha} + \frac{D}{2} \right) \right) \right] \quad (26)$$

d) *Computation of Weight of Axi-symmetric Solid Body of Revolution*

The net weight of the axis-symmetric solid body of revolution is considered into two components;  $W_1$  corresponding to the weight of inverted circular cone and  $W_2$  for the weight of the inverted cone below the circular anchor. Then, the net weight,  $W$  of the axis-symmetric solid body of revolution is computed as [Ref. Fig. 2]

$$W = \frac{\gamma \pi \tan \alpha}{3} \left[ \left( \frac{H}{\tan \alpha} + \frac{D}{2} \right)^3 - \frac{D^3}{8} \right] \quad (27)$$

e) *Net Breakout Resistance*

Referring to Fig. 3a and considering vertical force equilibrium, the net breakout resistance,  $P_{un}$  is obtained as

$$P_{un} = W - 2R_v \quad (28)$$

Substituting for  $R_v$  and  $W$  from Eqs. (26) and (27) respectively into Eq. (28) and with some algebraic transformations, the following result is obtained.

$$P_{un} = \frac{\gamma}{6 \sin\left(\frac{2}{3}\phi\right)} \left[ 2\pi \cos\left(\frac{2}{3}\phi\right) \left( C^3 - \frac{D^3}{8} \right) + C^3 + \frac{D^2}{4} (D - 3C) \right] \quad (29)$$

where,  $C = \left[ \frac{D}{2} + H \tan\left(\frac{2}{3}\phi\right) \right]$  and  $D$  = diameter of the circular anchor plate.

The above simple expression gives the net breakout resistance of a horizontal circular plate anchor in cohesionless soil medium. It is easy for hand calculations with no need of any tables or graphs.

The breakout factor,  $F_q$  is given as

$$F_q = \frac{P_{un}}{\gamma AH} \quad (30)$$

where,  $A$  is the area of horizontal circular anchor plate.

### III. COMPARISON WITH THE EXPERIMENTAL DATA

The results of theoretical predictions (Balla, 1961; Meyerhof and Adams, 1968; Vesic, 1971; Clemence and Veesaert, 1977; Murray and Geddes, 1987; Saeedy, 1987 and proposed solution) compared with the experimental data (Balla, 1961; Baker and Konder, 1966; Bemben and Kupferman, 1975; Ovesen, 1987; Sutherland et al., 1982; Illampurathi et al., 2002;

Murray and Geddes, 1987) are presented in Table 1a and comparisons with two field results reported by Sutherland et al. (1982) and Tucker (1987) are

presented in Tables 1b and 1c. The percentage deviations of the theoretical solutions with respect to the experimental results are reported in Tables 2a and 2b.

Table 1a: Comparison of breakout factor ( $F_q$ ) of experimental data with the theoretical solutions

Exp. Results	$H$ m	$\gamma$ kN/m <sup>3</sup>	$\phi$ (°)	$\lambda$	Exp. values	Proposed Method	Method 1	Method 2	Method 3	Method 4	Method 5	Method 6
	0.05		38	0.55	2.96	1.96	1.95	N.A.	N.A.	6.571	2.216	1.63
Balla	0.10		38	1.11	4.45	3.207	3.200	3.0	3.31	9.782	3.826	2.41
(1961)	0.15	18	38	1.68	6.11	4.74	4.768	4.78	5.157	13.517	5.773	3.3
	0.20		38	2.22	8.51	6.56	6.258	6.42	7.090	17.913	8.127	4.05
$D = 0.09$ m												
	0.24		38	2.77	11.0	8.66	8.594	7.51	9.476	22.811	10.804	6.27
Bemben	0.30		38	3.33	11.78	11.059	10.982	11.20	11.718	28.392	13.902	6.52
and			46	1	5.26	3.61	4.054	N.A.	N.A.	10.608	4.024	2.5
Kupferman		-	46	2	11.13	7.71	9.232	N.A.	N.A.	20.131	8.658	4.68
(1975)			46	3	27.66	20.36	16.534			32.569	14.091	7.23
			46	5	40.24	28.91	37.51	N.A.	N.A.	66.19	32.215	14.63



Table 1a: Contd

Exp.	$H$	$\gamma$	$\phi$ ( $^{\circ}$ )	$\lambda$	Exp.	Proposed Method	Method	Method	Method	Method	Method	
Results	m	kN/m <sup>3</sup>			values	Method	1	2	3	4	5	6
Ovesen	0.02		45	1	4.77	3.52	3.83	4.142	3.251	10.407	3.957	4.45
(1987)	0.04		45	2	10	7.44	8.688	7.14	6.569	19.587	8.471	4.615
$D = 0.02$	0.06		45	3	19	12.44	15.415	12.413	11.081	31.540	14.542	7.11
m	0.08	-	45	4	30	19.50	24.064	19.64	16.195	46.265	22.168	10.45
	0.10		45	5	37	27.63	34.635	25.862	N.A.	63.764	31.351	14.36
Murray	0.05		44	1	3.52	3.43	3.72	4.13	3.23	10.21	3.89	2.5
and	0.08		44	1.63	5.4	5.64	6.337	6.02	5.34	15.47	6.483	4.0
Geddes	0.15		44	3	14.54	12.26	14.405	12.32	11.033	30.537	14.182	7.0
(1987)	0.23		44	4.6	27.66	23.15	27.968	23.20	N.A.	54.38	26.74	12
$D = 0.0508$	0.25		44	5	35.19	26.40	32.056	25.86	N.A.	61.406	30.49	14.08
m	0.30	-	44	6	47.25	35.46	43.496	34.81	N.A.	80.79	40.899	19.39

Table 1a: Contd

Exp.	$H$	$\gamma$	$\phi$ ( $^\circ$ )	Exp.	Proposed Method	Method 1	Method 2	Method 3	Method 4	Method 5	Method 6	
Results	m	kN/m <sup>3</sup>	$\lambda$	values	Method	1	2	3	4	5	6	
	0.08		43	0.84	3.47	2.89	3.06	N.A.	N.A.	8.92	3.290	2.44
	0.19		43	1.9	7.13	6.52	7.22	6.97	5.892	17.572	7.604	4.48
Ilamparuthi												
	0.28		43	2.87	12.15	11.0	12.59	11.87	10.382	27.986	12.996	6.64
et al.												
	0.39	17	43	3.91	18.98	17.29	19.98	17.98	15.20	41.767	20.295	10
(2002)												
	0.47		43	4.75	24.74	23.27	27.19	24.50	N.A.	54.874	27.336	13.76
$D = 0.1$ m												
	0.59		43	5.97	35.64	33.54	39.64	33.18	N.A.	77.055	39.387	18.50
	0.69		43	6.91	48.36	42.73	50.83	43.18	N.A.	96.687	51.243	23.35
Sutherland												
			41	1	4.47	3.21	3.284	3.10	3.170	9.642	3.686	2.41
et al.												
			41	3	15.76	11.0	11.629	11.30	10.622	27.68	13.105	6.52
(1982)												
			41	4	20	16.73	17.688	16.85	15.849	40.07	19.836	9.66
			41	7	65.15	40.57	43.417	40.0	N.A.	90.77	48.122	22.48
			41	8	85.16	50.82	54.510	50.0	N.A.	112.97	60.247	27.82

Table 1a: Contd

Exp. Results	H m	$\gamma$ kN/m <sup>3</sup>	$\phi$ (°)	$\lambda$	Exp. values	Proposed	Method	Method	Method	Method	Method	Method
						Method	1	2	3	4	5	6
Baker and	0.52	17.9	42	7	40.607	41.642	47.571	41.877	N A	108.951	49.641	24.162
Konder	0.45	17.93	42	6	32.760	32.048	36.622	32.048	N A	74.450	39.635	18.133
(1966)	0.37	17.89	42	5	24.543	24.048	27.211	23.785	N A	56.893	29.616	15.088
D=0.0756m	0.45	17.92	42	9	55.140	63.846	73.602	63.043	N A	142.079	78.727	35.319
D =0.0504m	0.37	17.92	42	7.5	45.731	46.693	53.500	46.693	N A	56.830	57.496	27.157
	0.30	17.92	42	6	32.695	32.139	36.677	32.139	N A	74.652	39.734	18.061
D = 0.0378	0.45	17.97	42	12	68.635	106.073	123.259	105.85	N A	230.974	39.736	N A
m	0.37	17.97	42	10	61.657	75.957	88.550	75.957	N A	117.018	85.533	N A
	0.30	17.97	42	8	50.738	51.723	48.275	51.723	N A	142.032	60.261	28.078

N A: Not applicable

Note: Method 1: Meyerhof and Adams (1968)      Method 5: Murray and Geddes (1987)  
 Method 2: Saeedy (1987)                              Method 6: Vesic (1971)  
 Method 3: Balla (1961)  
 Method 4: Clemence and Veesaert (1977)

Table 1b: Comparison of net breakout resistance ( $P_{un}$  in kN) of field tests data with the theoretical methods

Field Test	H m	$\gamma$ kN/m <sup>3</sup>	$\phi$ (°)	$\lambda$	Field Test	Propose						
						Method	Method	Method	Method	Method	Method	
Sutherland	4.57	10.37	42	1.91	1601	1351	1544	1445	1244	3655	1589	938.6
et al.	5.18		42	2.17	2251	1777	2067	1660	1777	4738	2109	1079
(1982)	6.4		42	2.67	2064	2582	2553	2051	2195	5854	2553	1333.9
D = 2.39 m	7.0		42	2.94	2562	2659	4237	3702	3476	9088	4263	2201

Note:

Method 1. Meyerhof and Adams (1968)  
 Method 2. Saeedy (1987)  
 Method 3. Balla (1961)  
 Method 4. Clemence and Veesaert (1977)  
 Method 5. Murray and Geddes (1987)  
 Method 6. Vesic (1971)

Table 1c: Comparison of breakout factor ( $F_q$ ) of field tests data with the theoretical methods

Field Test	$H$	$\gamma$		Field	Proposed	Method	Method	Method	Method	Method	
Results	m	kN/m <sup>3</sup>	$\phi$ $\rho$ $\lambda$	Test	Method	1	2	3	4	5	6
	1.68	38	1.38	4.73	3.91	4.412	3.95	4.12	11.54	4.737	3.0
	1.93	42	1.59	7.95	5.14	5.80	5.18	4.957	14.38	6.036	3.41
	1.915	41.5	1.57	6.29	4.98	5.63	5.10	4.95	14.03	5.88	3.36
Tucker											
(1987)	1.732	41.5	1.42	6.69	4.48	5.021	4.78	4.39	12.83	5.273	3.32
	2.147	41.5	1.76	4.67	5.66	6.46	6.23	5.56	15.79	6.707	4.15
$D = 1.22$ m											
	1.952	41.5	1.6	7.09	5.09	5.761	5.18	4.94	14.28	6.0128	4.10
	2.196	41.5	1.8	7.27	5.95	6.82	7.02	5.86	16.33	7.068	4.29

Note:

Method 1. Meyerhof and Adams (1968)

Method 2. Saeedy (1987)

Method 3. Balla (1961)

Method 4. Clemence and Veesaert (1977)

Method 5. Murray and Geddes (1987)

Method 6. Vesic (1971)

Table 2a: Comparison of % deviations of the proposed and other theoretical methods with the experimental data

Exp. Results	$H$	$\gamma$		Proposed	Method	Method	Method	Method	Method	Method
	m	kN/m <sup>3</sup>	$\phi$ $\rho$ $\lambda$	Method	1	2	3	4	5	6
0.05		38	0.55	-33.784	-34.122	N.A.	N.A.	12.199	-25.135	-44.932
	0.10									
Balla		38	1.11	-27.933	-28.090	-32.584	-25.618	11.982	19.563	N.A.
	0.15									
(1961)		38	1.68	-22.422	-21.964	-21.768	-15.597	12.123	-5.516	-45.990
	0.20	18								
$D = 0.09$ m		38	2.22	-22.914	-26.463	-24.559	-16.686	11.049	-4.501	-52.409
	0.24									
		38	2.77	-21.273	-21.873	-31.727	-13.855	10.737	-1.782	-43.000
	0.30									
		38	3.33	-6.121	-6.774	-4.924	-0.526	14.102	18.014	-44.652

Bemben and	46	1	-31.369	-22.928	N.A.	N.A.	10.167	-23.498	-52.471
Kupferman	46	2	-30.728	-17.053	N.A.	N.A.	8.087	-22.210	-57.951
(1975)	46	3	-26.392	-40.224	N.A.	N.A.	1.775	-49.056	-73.861
	46	5	-28.156	-6.784	N.A.	N.A.	6.449	-19.943	-63.643

Table 2a: Contd.

Exp. Results	H m	$\gamma$ kN/m <sup>3</sup>	$\phi$ (°)	$\lambda$	Proposed Method	Method 1	Method 2	Method 3	Method 4	Method 5	Method 6
Baker and	0.52	17.9	42	7	-2.174	11.789	-2.174	N.A.	127.258	20.987	-43.395
Konder	0.45	17.93	42	6	-2.013	10.872	-3.087	N.A.	131.812	20.671	-33.96
(1966)	0.37	17.89	42	5	15.789	33.483	14.334	N.A.	157.671	42.777	N.A.
D=0.0756m	0.45	17.92	42	9	2.104	16.99	2.104	N.A.	24.272	25.728	26.861
D = 0.0504m	0.37	17.92	42	7.5	-1.7	12.181	-1.7	N.A.	128.329	21.53	27.762
	0.30	17.92	42	6	54.545	79.585	54.226	N.A.	236.523	-42.105	N.A.
	0.45	17.97	42	12	23.191	43.617	23.191	N.A.	89.787	38.723	N.A.
D= 0.0378m	0.37	17.97	42	10	1.942	-4.854	1.942	N.A.	179.935	18.77	122.33
	0.30	17.97	42	8	-31.369	-22.928	N.A.	N.A.	10.167	-23.498	-52.471

Table 2a: Contd.

Exp. Results	H m	$\gamma$ kN/m <sup>3</sup>	$\phi$ (°)	$\lambda$	Proposed Method	Method 1	Method 2	Method 3	Method 4	Method 5	Method 6
	0.02		45	1	-26.205	-19.706	-13.166	-31.845	11.943	-17.044	-6.709
Ovesen	0.04		45	2	-25.600	-13.120	-28.600	-34.310	9.587	-15.290	-53.850
(1987)	0.06	-	45	3	-34.526	-18.868	-34.668	-41.679	6.600	-23.463	-62.579
D = 0.02 m	0.08		45	4	-35.000	-19.787	-34.533	-46.017	5.422	-26.107	-65.167
	0.10		45	5	-19.919	-6.392	-30.103	N.A.	7.234	-15.268	-61.189



Murray	0.05	44	1	-2.557	5.682	17.330	-8.239	19.006	10.511	-28.977
and	0.08	44	1.63	4.444	17.352	11.481	-1.111	18.648	20.056	-25.926
Geddes	0.15	44	3	-15.681	-0.928	-15.268	-24.120	11.002	-2.462	-51.857
(1987)	0.23	44	4.6	-16.305	1.114	-16.124	N.A.	9.660	-3.326	-56.616
$D = 0.0508$	0.25	44	5	-24.979	-8.906	-26.51	N.A.	7.45	-13.356	-59.99
$m$	0.30	44	6	-24.952	-7.945	-26.328	N.A.	7.098	-13.441	-58.963

Table 2a: Contd.

Exp.	$H$	$\gamma$	$\phi$ ( $^\circ$ )	$\lambda$	Proposed Method	Method 1	Method 2	Method 3	Method 4	Method 5	Method 6
Results	m	kN/m <sup>3</sup>			Method	1	2	3	4	5	6
	0.08		43	0.84	-16.715	-11.816	N.A.	N.A.	15.706	-5.187	-29.683
	0.19	17	43	1.9	-8.555	1.262	-2.244	-17.363	14.645	6.648	-37.167
Ilamparuthi	0.28		43	2.87	-9.465	3.621	-2.305	-14.551	13.034	6.963	-45.350
et al.	0.39		43	3.91	-8.904	5.269	-5.269	-19.916	12.006	6.928	-47.313
(2002)	0.47	17	43	4.75	-5.942	9.903	-0.970	N.A.	12.180	10.493	-44.382
$D = 0.1$ m	0.59		43	5.97	-5.892	11.223	-6.902	N.A.	11.620	10.513	-48.092
	0.69		43	6.91	-11.642	5.108	-10.711	N.A.	9.993	5.962	-51.716
			41	1	-28.188	-26.532	-30.649	-29.083	11.570	-17.539	-46.085
Sutherland			41	3	-30.203	-26.212	-28.299	-32.602	7.563	-16.846	-58.629
et al.		-	41	4	-16.350	-11.560	-15.750	-20.755	10.035	-0.820	-51.700
(1982)			41	7	-37.728	-33.358	-38.603	N.A.	3.932	-26.137	-65.495
			41	8	-40.324	-35.991	-41.287	N.A.	3.266	-29.254	-67.332

Table 2b: Comparison of % deviations of the proposed and other theoretical methods with the field data

Field Test	H	$\gamma$	$\phi$ ( $^\circ$ )	$\lambda$	Proposed	Method	Method	Method	Method	Method	Method
Results	m	kN/m <sup>3</sup>			Method	1	2	3	4	5	6
Sutherland et al.	4.57		42	1.91	-15.61	-3.56	-9.744	-22.30	128.29	-0.74	-41.37
	5.18		42	2.17	-21.05	-8.174	-26.25	-21.05	110.48	-6.30	-52.06
(1982)	6.4	10.37	42	2.67	25.09	23.692	-0.63	6.347	183.62	23.69	-35.37
D = 2.39m	7.0		42	2.94	3.786	65.379	44.49	35.675	254.72	66.39	-14.07
	1.68		38	1.38	-17.33	-6.72	-16.49	-12.89	143.97	0.148	-32.004
	1.93		42	1.59	-35.34	-27.04	-34.84	-37.65	80.88	-24.07	-41.207
Tucker (1987)	1.91		41.5	1.57	-20.82	-10.49	-18.92	-21.30	123.05	-6.518	-40.320
	1.73	10.37	41.5	1.42	-33.03	-24.95	-28.55	-34.38	91.77	-21.18	-33.878
D = 1.22 m	2.14		41.5	1.76	21.2	38.33	33.405	19.06	238.11	43.618	-35.759
	1.95		41.5	1.6	-28.21	-18.74	-26.94	-30.32	101.41	-15.19	-28.832
	2.19		41.5	1.8	-18.15	-6.19	-3.44	-19.39	124.62	-2.7785	-37.097

Note: Method 1: Meyerhof and Adams (1968)  
 Method 2: Saeedy (1987)  
 Method 3: Balla (1961)  
 Method 4: Clemence and Veesaert (1977)  
 Method 5: Murray and Geddes (1987)  
 Method 6: Vesic (1971)

For a better understanding of the relative predictive capability of the proposed solution, a cumulative frequency distribution of the data corresponding to the percentage deviations is further reported in Tables 3a and 3b.



Table 3a: Cumulative frequency distribution of individual deviations

Absolute deviation (%)	Proposed Method	Method 1	Method 2	Method 3	Method 4	Method 5	Method 6
0-5	9	6	12	2	4	8	0
5-10	6	12	3	2	10	8	1
10-15	1	8	4	3	16	5	0
15-20	9	8	6	6	3	10	0
20-25	9	5	3	5	1	11	0
25-30	8	5	7	2	0	5	6
30-35	7	3	8	5	0	0	3
35-40	2	2	1	2	0	1	4
40-45	1	2	2	1	0	3	8
45-50	0	0	0	1	0	1	8
> 50	1	2	1	0	19	1	19

Note: Method 1: Meyerhof and Adams (1968)  
Method 2: Saeedy (1987)  
Method 3: Balla (1961)  
Method 4: Clemence and Veesaert (1977)  
Method 5: Murray and Geddes (1987)  
Method 6: Vesic (1971)

Table 3b: Cumulative frequency distribution of cumulative deviations

Absolute deviation (%)	Proposed Method	Method 1	Method 2	Method 3	Method 4	Method 5	Method 6
0-5	9	6	12	2	4	8	0
5-10	15	18	15	4	14	16	1
10-15	16	26	19	7	30	21	1
15-20	25	34	25	13	33	31	1
20-25	34	39	28	18	34	42	1

25-30	42	44	35	20	34	47	7
30-35	49	47	43	25	34	47	10
35-40	51	49	44	27	34	48	14
40-45	52	51	46	28	34	51	22
45-50	52	51	46	29	34	52	30
> 50	53	53	47	29	53	53	49

Note: Method 1: Meyerhof and Adams (1968)

Method 2: Saeedy (1987)

Method 3: Balla (1961)

Method 4: Clemence and Veesaert (1977)

Method 5: Murray and Geddes (1987)

Method 6: Vesic (1971)

From Tables 3a and 3b it is seen that, in 28 out of 29 cases, Balla's (1961) theoretical method shows absolute deviations in the range of 2% to 45%. The solution proposed by Meyerhof and Adams (1968) shows deviations in the range, 2% to 45% in 51 cases and in the remaining cases, the range is 55% to 100%.

Predictions based on the solution proposed by Vesic (1971) show deviations in the range of 2% to 45% for 22 cases and in the remaining 27 cases, the deviations are as high as 50% to 100%.

The method of Clemence and Veesaert (1977) shows deviations in the range, 2% to 45% for 34 cases and in the remaining 19 cases, the deviations are as high as 50% to 100%. The solution proposed by Murray and Geddes (1987) shows absolute deviations in the range of 2% to 45% for 51 cases and in the remaining 2 cases, the deviations are as high as 50% to 100%. Saeedy's (1987) method shows deviations in the range, 2% to 45% in 46 cases and in the remaining case, the range is 55% to 100%.

The proposed solution shows deviations in the range, 2% to 45% in 52 cases and in the remaining case, the range is 55% to 100%. Proposed solution and Saeedy's (1987) method show errors in the range, 0% to 5% in 9 and 12 cases respectively, whereas, in respect to the other methods, only 0 to 8 cases show deviations in this range.

From the above discussion it is seen that, Balla's (1961) method makes better predictions in 96% of the cases when compared to the experimental data.

In general, Balla's (1961) method shows a good agreement for dense sand up-to the embedment ratio of 5. It requires a chart for using the required functions. Vesic's (1971) method shows a good performance in 45% of the cases. However, it also requires a chart or table for using a proper value of the breakout coefficient.

The method of Meyerhof and Adams (1968) makes good predictions in 96% of the cases; but two charts are needed to select the proper values of the net breakout factor and the shape coefficient. The method of Clemence and Veesaert (1977) makes good predictions in only 64% cases. It involves an assumption in respect to the coefficient of earth pressure at rest.

The proposed analysis method considers failure surface in the form of frustum of a cone. It makes predictions that are very close to the experimental values in 98% cases. Thus, the performance appears to be superior to the other methods. Although the proposed analysis makes an approximation while using Kötter's (1903) equation, it is improved with a proper selection of the angle,  $\alpha$  as per Eq. (12). The integration is fairly simple, yielding a closed form expression for the net uplift resistance (Eq. 29), which is easy for calculations, with no need for graphs or tables. Kötter's (1903) equation plays a significant role in the analysis.

#### IV. CONCLUSIONS

The proposed analysis method is simple giving a closed form solution. It is also easy for hand calculations. Kötter's (1903) equation is successfully employed for axi-symmetric conditions with a proper choice of angle at which the failure surface intersects the ground level. No assumptions are necessary for the coefficient of earth pressure and the results show a very close agreement with the experimental data.

#### REFERENCES RÉFÉRENCES REFERENCIAS

1. Adams, J. I. and Hayes, D. C. (1967). "The uplift capacity of shallow foundations" Ontario Hydro Research Quarterly, Vol. 19, Issue 1, pp. 1–15.

2. Baker, W.H. and Konder, R.L. (1966). "Pullout load capacity of a circular earth anchor buried in sand" Highway Res. Rec., Vol. 108, pp. 1-10.
3. Balla, A. (1961). "The resistance to breaking out of mushroom foundations for pylons" Proc., 5<sup>th</sup> Intl. Conf. Soil Mechanics and Foundation Engineering Division, 1, Paris, France, pp. 569-576.
4. Bembem, S. M. and Kupferman, M. (1975). "The vertical holding capacity of marine anchor flukes subjected to static and cyclic loading" Proc., 7<sup>th</sup> Offshore Technology Conf., Houston, Texas, OTC2185, pp. 363-374.
5. Bhattacharya, P. and Kumar, J. (2016). "Uplift capacity of anchors in layered sand using finite-element limit analysis: formulation and results" Int. J. Geomech., DOI: 10.1061/(ASCE)GM.1943-5622.0000560, 04015078
6. Clemence, S. P. And Veesaert, C. J. (1977). "Dynamic pullout resistance of anchors in sand" Proc. of the International Conference on Soil-Structure Interaction, Roorkee, India, pp.389-397.
7. Dewaikar, D. M. And Halkude, S. A. (2002a). "Seismic passive/active thrust on retaining wall-point of application" Soils and Foundations, Vol. 42, Issue 1, pp. 9-15, DOI: 10.3208/sandf.42.9.
8. Dewaikar, D. M. And Halkude, S. A. (2002b). "Active thrust on bracing system of open cuts in cohesionless soil- point of application" Indian Geotechnical Journal, Vol. 32, pp. 407-420.
9. Dewaikar, D. M. And Mohapatro, B.G. (2003). "Computation of Bearing Capacity Factor  $N_{\gamma}$ -Terzaghi's Mechanism" International J. of Geomechanics (ASCE), Vol. 3, Issue 1, pp. 123-128, DOI: 10.1061/(ASCE)1532-3641(2003)3:1(123).
10. Deshmukh, V. B., Dewaikar, D. M. and Deepankar Choudhury (2010). "Computation of uplift capacity of pile anchors in cohesionless soil" Acta Geotechnica, Vol.5, Issue 2, pp. 87-94, DOI: 10.1007/s11440-010-0111-6.
11. Deshmukh, V., Dewaikar, D. and Deepankar Choudhury (2010). "Analysis of rectangular and square anchors in cohesionless soil" International Journal of Geotechnical Engineering, Vol.04, Issue 01, pp. 79-87, DOI: 10.3328/IJGE.2010.04.01.79-87.
12. Ghaly, A. M., Hanna, A. M., and Hanna, M. S. (1991). "Uplift behaviour of screw anchors in sand. I: Dry sand" J. Geotech. Engrg. (ASCE), Vol. 117, Issue 5, pp. 773-793, DOI: 10.1061/(ASCE)0733-9410(1991)117:5(773).
13. Giffels, W. C., Graham, R. E. And Mook, J. F. (1960). "Concrete cylindrical anchors proved for 375 KW tower line" Electrical World, Vol. 159, pp. 46-49.
14. Hao Dong xu, Fu sheng nan and Chen Rong (2014). "Numerical analysis of uplift capacity of circular plate anchor in sand" Electronic Journal of Geotechnical Engineering, Vol. 19, pp. 18947-18961.
15. Ilamparuthi, K. Dickin, E. A., and Muthukrisnaiah, K. (2002). "Experimental investigation of the uplift behavior of circular plate anchors embedded in sand" Can. Geotech. Journal, Vol. 39, Issue 3, pp. 648-664, DOI: 10.1139/t02-005.
16. Ireland, H. O. (1963). "Discussion on Uplift resistance of transmission tower footings by E.A. Turner" J. Power Division (ASCE), Vol. 89, Issue 1, pp. 115-118.
17. Kananyan, A. S. (1966). "Experimental investigation of the stability of base of anchor foundations" Soil Mechanics and Foundation Engineering, Vol. 3, Issue 6, pp. 387-392, DOI: 10.1007/BF01702954.
18. Kötter, F. (1903). "Die Bestimmung des Drucks an gekrümmten Gleitflächen, eine Aufgabe aus der Lehrevom Erddruck" Sitzungsberichte der Akademie der Wissenschaften, Berlin, pp. 229-233.
19. Kumar, J. And Kouzer, K. M. (2008). "Vertical uplift capacity of horizontal anchors using upper bound limit analysis and finite elements" Can. Geotech. Journal, Vol. 45, Issue 5, pp. 698-704, DOI: 10.1139/T08-005.
20. Mariupol' skii, L.G. (1965). "The bearing capacity of anchor foundations" Osnovaniya Fundamentyi Mekhanika Gruntov, Vol. 3, Issue 1, pp. 14-18.
21. Merifield, R.S. and Sloan, S.W. (2006). "The ultimate pullout capacity of anchors in frictional soils" Can. Geotech. Journal, Vol. 43, Issue 8, pp. 852-868, DOI: 10.1139/t06-052.
22. Meyerhof, G.G. and Adams, J.I. (1968). "The ultimate uplift capacity of foundations" Can. Geotech. Journal, Vol.5, Issue 4, pp. 225-244, DOI: 10.1139/t68-024.
23. Mors, H. (1959). "The behavior of mast foundations subjected to tensile forces" Bautechnik, Vol. 36, Issue 10, pp. 367-378.
24. Murray, E.J., Geddes, J. D. (1987). "Uplift of anchor plates in sand" J. Geotech. Engrg (ASCE), Vol. 113, Issue 3, pp. 202-215, DOI: 10.1061/(ASCE)0733-9410(1987)113:3(202).
25. Ovesen, N. K. (1981). "Centrifuge tests on the uplift capacity of anchors" Proc., 10<sup>th</sup> International Conference on Soil Mechanics and Foundation Engineering, 1, Stockholm, pp. 717-722.
26. Saeedy, H. S. (1987). "Stability of circular vertical earth anchors" Can. Geotech. Journal, Vol. 24, Issue 3, pp. 452-456, DOI: 10.1139/t87-056.
27. Sakai, T. and Tanaka, T. (2007). "Experimental and numerical study of uplift behavior of shallow circular anchor in two layered sand" J. Geotech. Engrg. (ASCE), Vol. 133, Issue 4, pp. 469-477, DOI: 10.1061/(ASCE)1090-0241(2007)133:4(469).

28. Sutherland, H.B. (1965). "Model studies for shaft raising through cohesion less soils" Proc., 6<sup>th</sup> International Conference on Soil Mechanics and Foundation Engineering, 2, Montreal, pp. 410-413.
29. Sutherland, H. B., Finlay, T. W., and Fadl, M. O. (1982). "Uplift capacity of embedded anchors in sand" Proc., of the 3<sup>rd</sup> International Conference on the Behaviour of Offshore Structures, 2, Cambridge, pp. 451-463.
30. Tagaya, K., Scott, R. F., and Aboshi, H. (1988). "Pullout resistance of buried anchor in sand" Soils and Foundations, Vol. 28, Issue 3, pp. 114-130, DOI: 10.3208/sandf1972.28.3\_114.
31. Tang, C., Toh, K., and Phoon, K. (2014). "Axisymmetric lower-bound limit analysis using finite elements and second-order cone programming" J. Eng. Mech. (ASCE), Vol. 140, Issue 2, pp. 268-278, DOI: 10.1061/(ASCE)EM.1943-7889.0000669.
32. Tom Bowling (2012). "Simplified analysis of the strength of anchor plates in a cohesionless soil" Australian Geomechanics, Vol. 47, Issue 2, pp-1-16.
33. Tucker, K. D. (1987). "Uplift capacity of drilled shafts and driven piles in granular materials" Foundations for transmission line towers, Geotechnical Special Publication (ASCE), Edited by J.-L. Briaud, 8, New York, pp. 142-159.
34. Turner, E.Z. (1962). "Uplift resistance of transmission tower footing" J. Power Division (ASCE), Vol. 88, Issue 2, pp. 17-34.
35. Vesic, A. S. (1971). "Breakout resistance of objects embedded in ocean bottom" J. of the Soil Mechanics and Foundation Engineering Division (ASCE), Vol. 97, Issue 9, pp. 1183-1205.

$W_2$  = weight of the inverted cone below the circular anchor  
 $W$  = net weight of the axis-symmetric solid body of revolution  
 $\alpha$  = inclination of failure plane with the horizontal  
 $\phi$  = soil friction angle  
 $\gamma$  = unit weight of soil  
 $\lambda$  = embedment ratio =  $H/D$

#### List of symbols

The following symbols are used in this paper.

$A$  = area of circular anchor plate  
 $C_1$  = integration constant  
 $dp$  = elemental soil reactive pressure  
 $dR$  = elemental soil reaction  
 $dR_v$  = elemental vertical component  
 $ds$  = elemental failure surface length  
 $d\alpha$  = elemental angle  
 $D$  = diameter of circular anchor plate  
 $F_g$  = breakout factor  
 $H$  = height of circular anchor plate  
 $p$  = soil reactive pressure distribution  
 $P_p$  = passive thrust  
 $P_u$  = ultimate breakout resistance  
 $P_{un}$  = net breakout resistance  
 $R$  = soil reactive force on the failure plane  
 $R_v$  = vertical soil reaction component  
 $W_1$  = weight of inverted circular cone





GLOBAL JOURNAL OF RESEARCHES IN ENGINEERING: E  
CIVIL AND STRUCTURAL ENGINEERING  
Volume 19 Issue 4 Version 1.0 Year 2019  
Type: Double Blind Peer Reviewed International Research Journal  
Publisher: Global Journals  
Online ISSN: 2249-4596 & Print ISSN: 0975-5861

## Regression Modelling of California Bearing Ratio (CBR) Predicted from Index

By Kayode-Ojo, N., Ehizokhale, M. E. & Ehiorobo, J. O.

*University of Benin*

**Abstract-** Obtaining California Bearing Ratios (CBR) of soils for road construction projects could be a time-consuming and costly exercise. In order to reduce the time and cost of obtaining CBR values of soils, this paper presents a mathematical relationship between index properties of lateritic soils, which can easily be obtained from simple laboratory investigations, and their CBR (soaked and unsoaked) values.

Lateritic Soils were sourced from borrow pits in Edo State in Nigeria. Laboratory tests were conducted to determine the Atterberg limits, grading and CBR of soils obtained. Tests conducted include: sieve analysis, liquid limits, plastic limits, plasticity index (index properties), density, natural moisture content and CBR (soaked and unsoaked) tests. Using multivariate linear regression models, a mathematical model was developed to obtain a relationship between the CBR (soaked and unsoaked) of obtained soils with their index properties, which were obtained from the laboratory investigations conducted.

**Keywords:** *california bearing ratio, index properties, multivariate regression model, plasticity index, subgrade.*

**GJRE-E Classification:** FOR Code: 090599



*Strictly as per the compliance and regulations of:*



© 2019. Kayode-Ojo, N., Ehizokhale, M. E. & Ehiorobo, J. O. This is a research/review paper, distributed under the terms of the Creative Commons Attribution-Noncommercial 3.0 Unported License (<http://creativecommons.org/licenses/by-nc/3.0/>), permitting all non commercial use, distribution, and reproduction in any medium, provided the original work is properly cited.

# Regression Modelling of California Bearing Ratio (CBR) Predicted from Index Properties for Lateritic Soils

Kayode\_Ojo, N.<sup>α</sup>, Ehizokhale, M. E.<sup>σ</sup> & Ehiorobo, J. O.<sup>ρ</sup>

**Abstract-** Obtaining California Bearing Ratios (CBR) of soils for road construction projects could be a time-consuming and costly exercise. In order to reduce the time and cost of obtaining CBR values of soils, this paper presents a mathematical relationship between index properties of lateritic soils, which can easily be obtained from simple laboratory investigations, and their CBR (soaked and unsoaked) values.

Lateritic Soils were sourced from borrow pits in Edo State in Nigeria. Laboratory tests were conducted to determine the Atterberg limits, grading and CBR of soils obtained. Tests conducted include: sieve analysis, liquid limits, plastic limits, plasticity index (index properties), density, natural moisture content and CBR (soaked and unsoaked) tests. Using multivariate linear regression models, a mathematical model was developed to obtain a relationship between the CBR (soaked and unsoaked) of obtained soils with their index properties, which were obtained from the laboratory investigations conducted.

The statistical regression analyses showed a good correlation between experimental obtained and the predicted CBR values. The coefficient of determination (R<sup>2</sup>) differed for both the soaked and the unsoaked CBR values. The selected independent variables (index properties) had a better correlation with the unsoaked CBR than the soaked CBR. However, both CBR values did not satisfy the condition for road base and sub base as some of the materials can be qualified as subgrade material only after thorough compaction by several passes with vibratory roller or excavation and replacement with suitable fill materials has been carried out.

**Keywords:** *california bearing ratio, index properties, multivariate regression model, plasticity index, subgrade.*

## 1. INTRODUCTION

In highway design, bearing capacity of sub grade soil is of great importance in the determination of pavement thickness (Forkenbrock and Weisbrod, 2001). The sub-grade layer, which is the bottommost layer, is mostly affected as load comes upon it (Forkenbrock and Weisbrod, 2001). In Nigeria, California Bearing Capacity (CBR) test is one of the most common and comprehensive method currently used to determine the sub-grade strength. It is essentially a measure of the shear strength of a material at a known density and moisture content. The shear strength of soils can generally be considered in terms of Coulomb's Law, as discussed by Croney, (1977). Sub-grade plays an

important role in imparting structural stability to the pavement structure as it receives loads imposed upon it by road traffic (Croney, 1977; Forkenbrock and Weisbrod, 2001). A range of factors influence the CBR of a particular material. Carter and Bentley (1991) mentioned the soil type, density, moisture content and method of sample preparation as playing important roles. Apart from the material properties themselves, moisture conditions are also pivotal. The moisture conditions at which the material is to be used vary according to climatic region, and as such the soaked CBR test is used to simulate the worst likely conditions in service and the un-soaked simulate the normal field condition (Kumar, 2014). For determining soaked value of the CBR, the sample is submerged in water for 96 hours prior to performing the penetration test.

In the tropics, lateritic soils are used as a road making material and they form the sub-grade of most tropical roads (Alayaki, 2012). Lateritic soil is generally believed to be a very good sub-grade material for road construction. Nigerian roads and highways are usually constructed on compacted lateritic soils foundation. Although some lateritic soils (especially gravelly aggregates) have been found to be quite good in pavement construction particularly those with appropriate geotechnical characteristics, the limited availability of these materials in the country is a challenge to constructing durable roads and highways (Alayaki, 2012).

A good highway or road is a gateway to national development as they create access to infrastructure (Okovido and Musa, 2004). In Nigeria, the failure of engineering facilities such as roads and embankments has attracted numerous opinions on the causes (Orie and Nweni, 2015). These failures have necessitated the need for research which revealed that the causes of the highway failure were traceable to indiscriminate dumping of waste, the use of substandard materials and incompetent contractors. Apart from these mentioned causes, insufficient knowledge of the sub-grade of the intended site before use is also a contributing factor of failure (Orie and Nweni, 2015). Huge amounts of money are spent on road maintenance on annual basis, yet the pavement does not last for a long period of time before its fails as a result of not knowing the condition of the sub-grade before design (Alayaki, 2012). CBR test is

*Author α σ ρ: Department of Civil Engineering, Faculty of Engineering, University of Benin, PMB 1154 Benin City, Nigeria.  
e-mail: engrgozi@yahoo.com*

one of those parameters that serves as an indication of sub-grade soil strength and hence the service-life of a pavement depends on the sub-grade (Sathawara and Patel, 2013). Comparing soaked and un-soaked CBR will help to know the behavior of the soil before and after construction. Knowing this will help to minimize the high rate of pavement failure, and money spent on yearly maintenance will be used for other projects that will boost the economic and social development of the country (Orie and Nweni, 2015; Alayaki, 2012).

The aim of this study is to develop a relationship between the index properties of lateritic soils and their soaked and unsoaked CBRs of lateritic soils. This relationship will help in quick assessment of CBRs of soils during the design stages of engineering projects.

II. MATERIALS AND METHOD

a) Study Area

The study area covers Ebohimi, and Ekpoma in Edo central senatorial zone of Edo state, Nigeria as shown in figure 1.

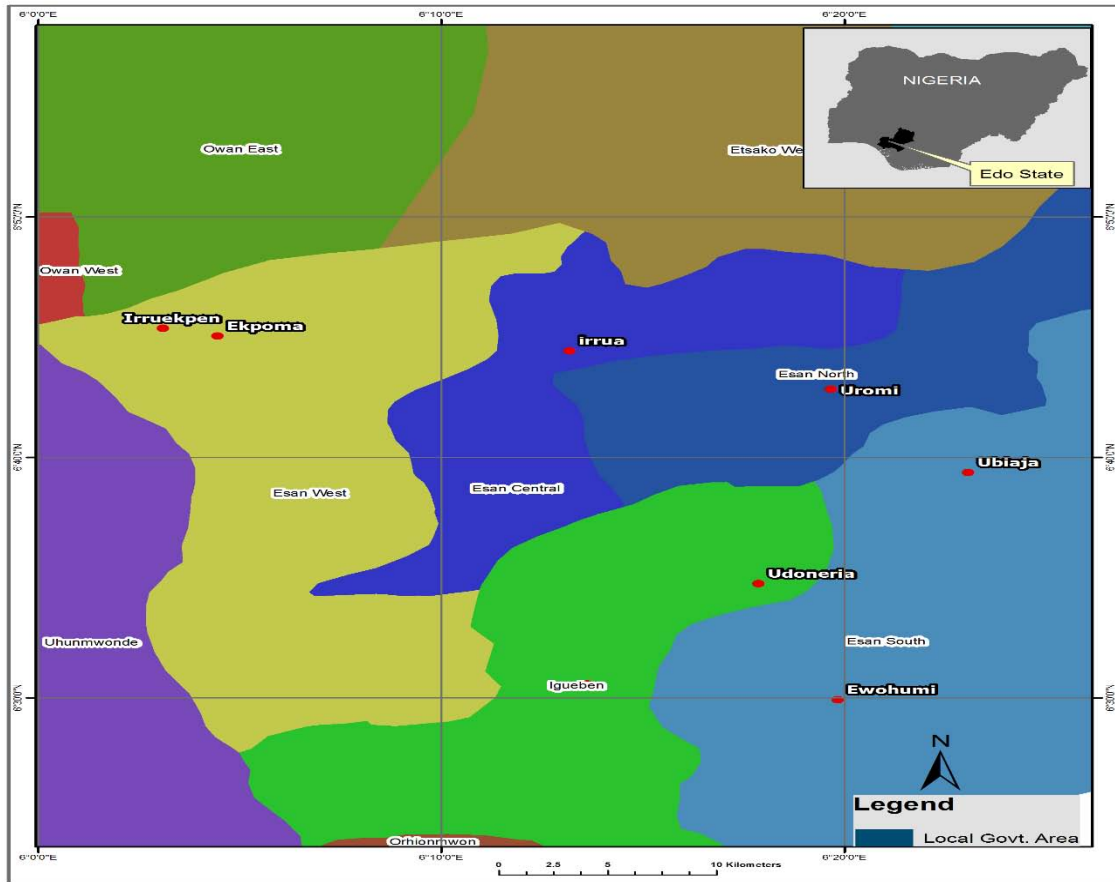

Figure 1: Location Map for the study area

b) Sample Collection

In order to have sufficient and reliable data for the targeted analysis, soil samples were collected from the study area. The samples were collected along the road, and borrow pits. A total of Twenty (20) disturbed

samples were collected, using hand auger at a depth of 1 m to 2 m. Some were taken from both side of the road within a reasonable sampling interval of 2 to 3 km. The sample locations are shown in Table 1.

Table 1: Sample Locations

S/N	Location	Number of Samples Collected	Depth / Chainage
1	Ebohimi borrow pit	10	1 to 3m
2	Ekpoma road /BP	10	0.6-3m&43+230 – 65+100

c) *Laboratory Tests*

All laboratory tests were done in accordance with the British Standard Specifications B.S 1377: 1990 (BS, 1990). The tests included:

- a. Atterberg limits,
- b. Particle (grain) size analysis,
- c. California bearing ratio and
- d. Compaction test.

d) *Analysis of Data using Multivariate Regression*

To find the dependence of the measured geotechnical parameters on the soaked and un-soaked

$$\hat{y} = \beta_0 + \beta_1x_1 + \beta_2x_2 + \dots + \beta_5x_5 + \varepsilon \tag{1}$$

Where  $y$  is the dependent variables,  $\beta_0, \beta_1, \beta_2, \dots, \beta_5, \varepsilon$  are the coefficient to be determined (regression coefficients) and  $x_1, x_2, \dots, x_5$  are the independent variables.

The parameters of the equation were computed using E-view version 9.0 statistical software.

1. The first phase in the model development was the transformation of the independent variables (%passing 0.075mm and 0.425mm sieve, liquid limit, plastic limit, plastic index, maximum dry density (g/cm<sup>3</sup>), optimum moisture content) into readable codes that can be used as input files for the analysis.

CBR, mathematical modeling using multivariate regression analysis was done (Bello, 2012). CBR values were taken as dependent variables and index properties (LL, PL, PI, OMC, MDD (compaction tests values), % passing of 0.075mm and 0.425mm) as independent variables.

Multivariate regression equation of the form as shown in Equation 1 was used.

2. The second phase was to define the dependent variables (Soaked and un-soaked CBR) and the model analysis method. In this case, least square regression based on multivariate model was selected.
3. The third and final phase was to compute the coefficient statistics, and assess the model strength using coefficient of determination, thereafter generate the multivariate equations.

### III. RESULTS AND DISCUSSION

a) *Laboratory Tests Results*

The results of the laboratory tests for Ebhohimi borrow pits are shown in Table 2.

Table 2: Results for Ebhohimi borrow pits

S/N	Sample Location	%Passing 0.075mm (no200)	%Pasng 0.425 mm	Liquid Limit (%)	Plastc Limit (%)	Plasticity Index (%)	MDD (g/cm <sup>3</sup> )	OMC (%)	CBR Soaked (%)	CBR Unsoaked (%)	ASSHTO Soil Classifica-tion
1	Ebhohimi borrowpit 1, Sample 1	44.1	66.2	57.49	18.57	38.92	1.81	16.92	0.63	0.71	A-7-5
2	Ebhohimi borrow pit 1, Sample 2	48.1	69.8	56.28	15.5	35.92	1.75	17.30	3.63	5.70	A-7-5
3	Ebhohimi borrow pit 1, Sample 3	42.1	64.1	54.75	16.4	38.5	1.72	14.30	8.18	9.72	A-7-5
4	Ebhohimi \borrow pit 1, Sample 4	38.2	61.08	46.31	16.97	29.34	1.74	14.30	2.38	2.89	A-7-5
5	Ebhohimi borrow pit 1, Sample 5	50.66	73.35	56.45	26.11	30.34	1.65	19.76	1.39	1.46	A-7-5
6	Ebhohimi borrow pit 2, Sample 1	46.4	66.8	54.49	23.71	30.78	1.65	15.20	3.71	4.09	A-7-5
7	Ebhohimi borrow pit 2, Sample 2	49.1	67.2	58.17	21.23	36.94	1.75	17.6	1.91	6.19	A-7-5

8	Ebhohimi borrow pit 2, Sample 3	49.9	68.5	53.04	19.46	33.58	1.75	17.34	1.23	1.30	A-7-5
9	Ebhohimi borrow pit 2, Sample 4	44.5	64.9	46.31	20.19	26.12	1.68	15.54	4.82	6.48	A-7-5
10	Ebhohimi borrow pit 2,	52.16	75.01	54.64	19.78	34.88	1.65	17.40	0.88	1.51	A-7-5

Based on the obtained test results from Ebhohimi borrow pit (Table 2), the soil is classified as A-7-5 (sandy soil). From the conventional Atterberg limit tests, liquid limit values are in the range of 46.31 to 58.17, plasticity limit values are of 15.5 to 26.45 and plasticity index value of 26.12 to 41.06 as shown in Table 2. Soils with liquid limit less than 30% are considered to be of low plasticity, those with liquid limit between 30% and 50% exhibit medium plasticity and those with liquid limit greater than 50% exhibit high plasticity (Arora, 2004). All samples exhibited high plasticity except sample 4 in pits 1 and 2 which exhibited medium plasticity. The particle size distribution passing through 0.075mm and 0.425mm ranged between 38.2 to 52.16 and 61.08 to 73.35, which

indicate fine grained soils, the soil can be classified as sandy soil (Arora, 2004). The unsoaked CBR values ranged between 0.71 and 9.72, while its corresponding soaked samples range between 0.63 and 8.18%. The percentage decreases from soaked CBR to unsoaked CBR. This implies that as water is absorbed into the compacted specimen, the resistance to penetration becomes drastically reduced. It has been recommended by Federal Ministry of Works and Housing that the values of CBR for road base, sub base and subgrade should not be less than 80%, 30% and 10% respectively under soaked condition (FMWH, 1994). It can be seen that samples do not satisfy the condition for road subgrade, base and sub-base. Hence the CBR from that particular borrow pits are very low.

Table 3: Results for Ekpoma

S/N	Sample Location	%Passig 0.075mm (no 200)	%Pas sing 0.425 mm	Liquid Limit (%)	Plastic Limit (%)	Plastic Index (%)	MDD (g/cm <sup>3</sup> )	OMC (%)	CBR Soaked (%)	CBR Unsoa ked (%)	ASSHTO Soil Classificat ion
1	EkpomaUjio ba RD,1.4m	36.06	68.35	53.32	19.00	34.32	1.59	18.60	17.6	33.2	A-7-5
2	EkpomaUjio ba 0.65m	24.32	65.85	43.81	15.86	27.95	1.62	19.38	18.2	32.49	A-7-5
3	Ekpoma Borrow pit 1 0.75m	36.89	67.99	36.74	15.51	21.23	1.78	10.8	6.34	11.4	A-6
4	Ekpoma Borrow pit 2 0.75m	22.15	73.16	27.76	13.43	14.33	1.69	13.2	10.9	12.8	A-2-6
5	Ekpoma Borrow pit 2 1.5m	23.14	75.49	41.52	13.70	27.55	1.72	14.9	8.85	12.8	A-2-6
6	Ekpoma Borrow pit 3 1.5m	21.13	76.44	35.76	15.18	20.58	1.76	13.6	3.48	10.2	A-2-6
7	Ekpoma 50+500	40.44	74.7	45.80	25.2	14.29	1.59	16.0	8.29	10.1	A-7-5
8	Ekpoma 43+230	40.74	78.75	33.80	19.74	14.06	1.65	14.0	9.03	11.1	A-6
9	Ekpoma 47+500	36.23	77.43	29.38	17.45	11.92	1.71	13.6	4.99	5.09	A-6
10	Ekpoma 65+100	29.35	73.32	43.81	15.86	27.95	1.62	19.4	7.43	12.67	A-2-6

The laboratory tests results for soils from Ekpoma are presented in Table 3. Based on the obtained test results of plasticity, the soil classification was made in accordance to the AASHTO classification system, and it was classified as A-7-5, A-2-6, A-6. From the conventional Atterberg limit tests, liquid limit value ranging from 27.76 to 53.32, plastic limit value of 13.43 to 25.20 and plasticity index value of 11.92 to 34.32. Soils with liquid limit less than 30% are considered to be of low plasticity, those with liquid limit between 30% and 50% exhibit medium plasticity and those with liquid limit greater than 50% exhibit high plasticity. The values of California bearing ratio have been shown in Table 1. It has unsoaked CBR ranges between 10.1 and 33.2, which that of its corresponding soaked samples range between 3.48 and 17.6%. The percentage decreases from soaked CBR to unsoaked CBR. This implies that as water is absorbed into the compacted specimen, the resistance to penetration becomes drastically reduced. It has been recommended by Federal Ministry of Works that the

values of CBR for road base, subbase and subgrade should not be less than 80%, 30% and 10% respectively under soaked condition. It can be seen that some of the samples satisfy the condition for road subgrade, but for it to be used for base and subbase materials, it is advisable to improve the soil by stabilization or excavation of the soil.

b) *Regression Modelling*

For this analysis, geotechnical properties including sieve analysis, liquid limit, plastic limit, plastic index, optimum moisture content and maximum moisture content were taken as independent variables as shown in tables 4 and 5 while CBR soaked and unsoaked were taken as the dependent variables. To conduct the multivariate linear regression and solve the regression equation, multivariate statistical software E-view 9.0 was employed. The interphase of the statistical software containing both the dependent and independent variables is presented in tables 6 and 7 representing both the soaked and unsoaked CBR respectively. For ease of data transformation, the selected independent variables were coded as follows

Table 4: Independent variable codes and their definition

S/No.	Variable Code	Variable Definition
1	X1	% Passing 0.075mm sieve
2	X2	% Passing 0.425mm sieve
3	X3	Liquid limit (%)
4	X4	Plastic limit (%)
5	X5	Plastic index (%)
6	X6	Maximum dry density (g/cm <sup>3</sup> )
7	X7	Optimum moisture content (%)

Table 5: Input data for analysis (Ebhoimi)

X1	X2	X3	X4	X5	X6	X7	SOAKED CBR	UNSOAKED CBR
44.1	66.2	57.49	18.57	38.92	1.81	16.92	0.63	0.71
48.1	69.8	56.28	15.5	35.92	1.75	17.30	3.63	5.70
42.1	64.1	54.75	16.4	38.5	1.72	14.30	8.18	9.72
38.2	61.08	46.31	16.97	29.34	1.74	14.30	2.38	2.89
50.66	73.35	56.45	26.11	30.78	1.65	19.76	1.39	1.46
46.4	66.8	54.49	23.71	30.78	1.65	15.20	3.71	4.09
49.1	67.2	58.17	21.23	36.94	1.75	16.81	1.91	6.19
49.9	68.5	53.04	19.46	33.58	1.75	17.34	1.23	1.30
44.5	64.9	46.31	20.19	26.12	1.68	15.54	4.82	6.48
52.16	75.01	54.64	19.78	34.88	1.65	17.40	0.88	1.51



Table 6: Software interphase showing the coefficient estimates of the dependent and independent variables

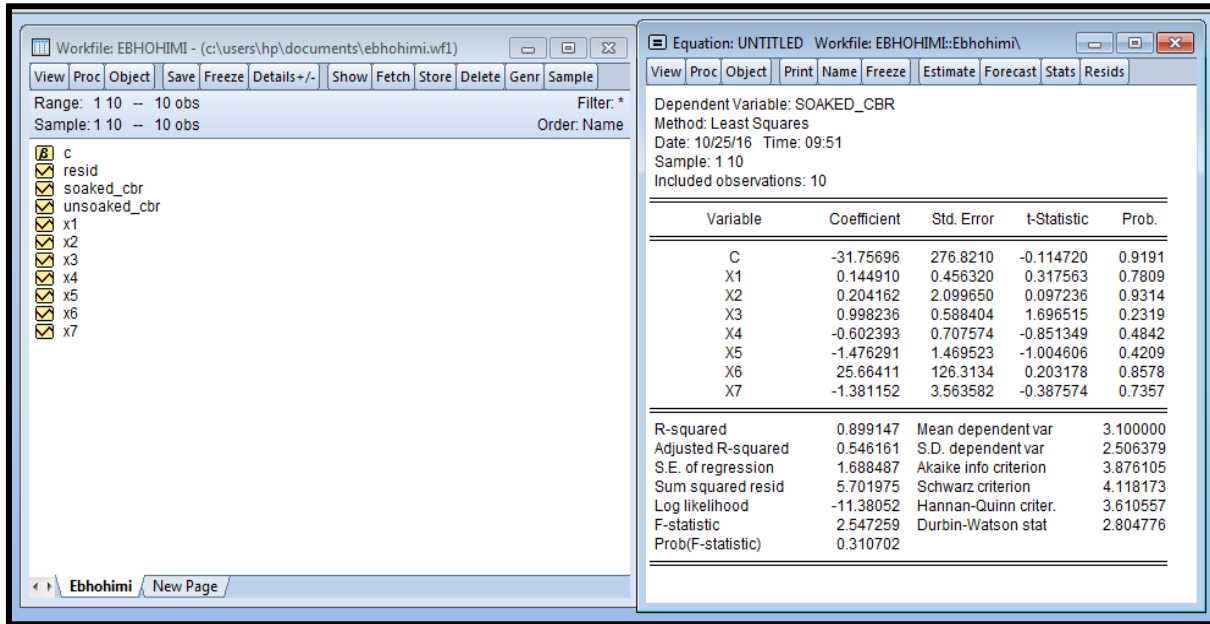
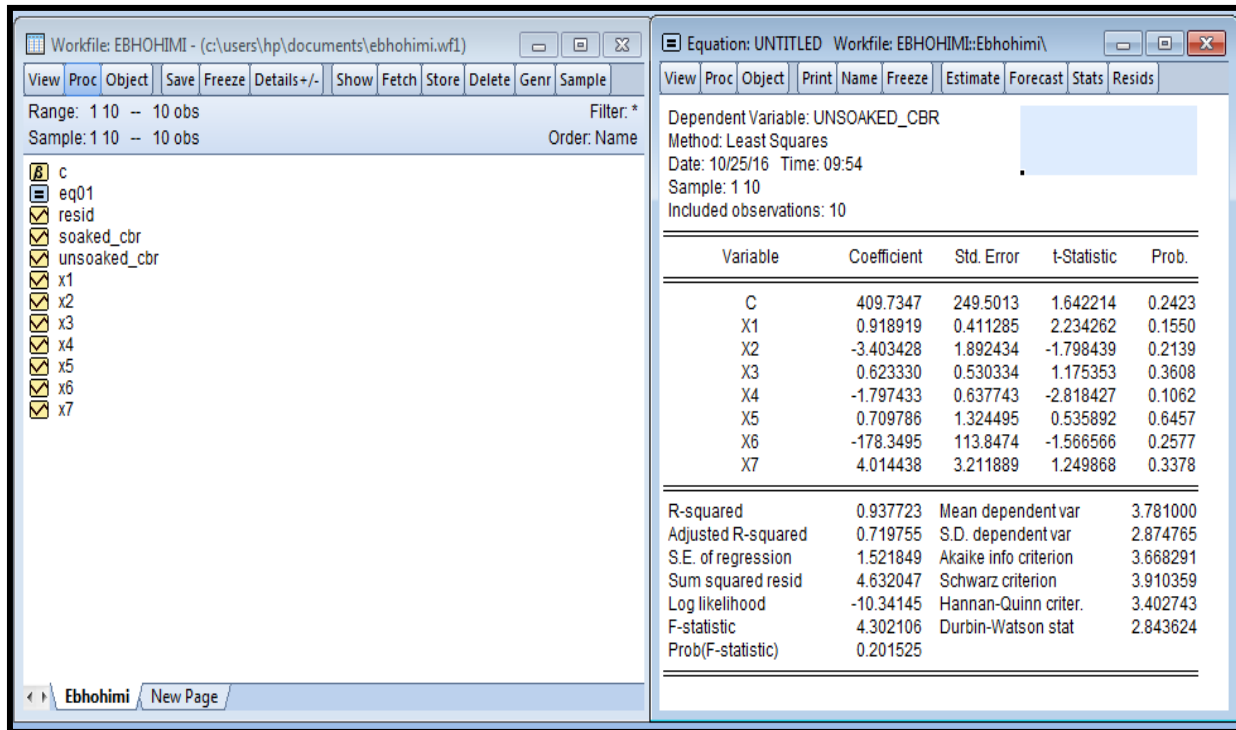

Table 7: Software interphase showing the coefficient estimates of the dependent and independent variables



i. Analysis Test Results of soaked and un-soaked CBR for Ebhohimi samples

From the result of Tables 6 and 7, it was observed that the coefficient of determination ( $R^2$ ) differs for both the soaked and the unsoaked CBR analysis (0.899147 and 0.937723) respectively. The explanation is that the selected independent variables (percent passing 0.075mm sieve size, percent passing 0.425mm sieve size, liquid limit, plastic limit, plastic index,

maximum dry density and optimum moisture content) had a better correlation with the unsoaked CBR than the soaked CBR. In addition, the high coefficient of determination as observed revealed the suitability of multivariate linear regression model in explaining the dependence of the independent variables on the regressor. Normally, this would imply a very good fit for the model. Thereafter, multivariate linear regression equation was developed as shown in Figure 2 and 3.

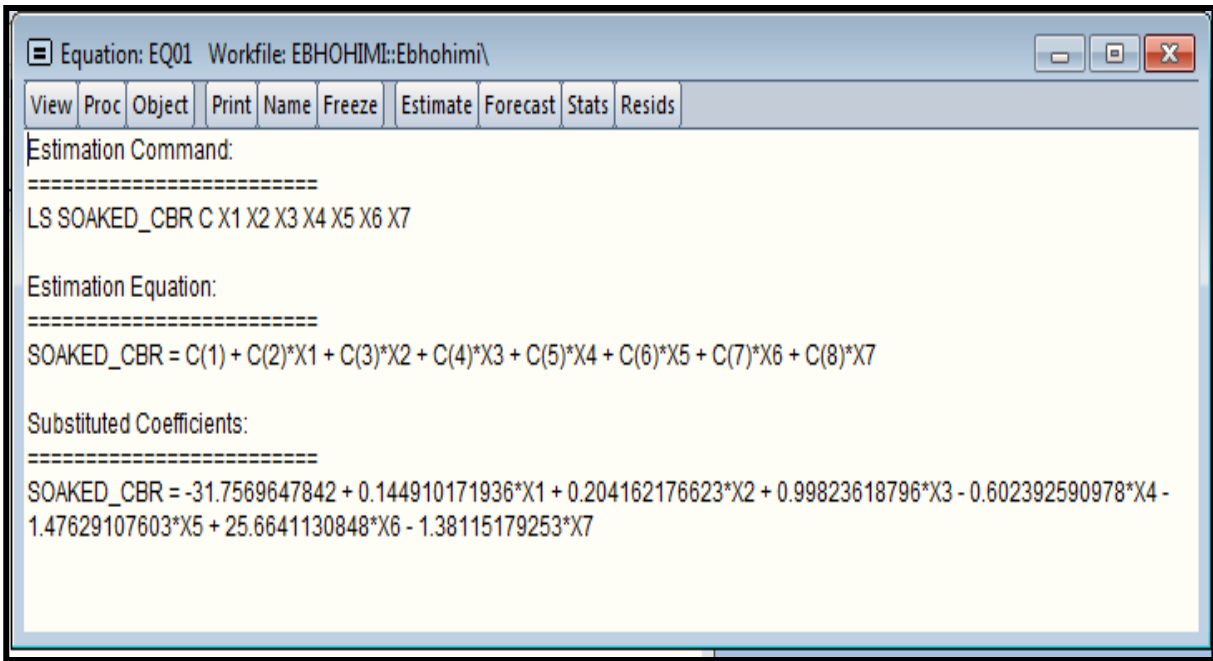

Figure 2: Multivariate linear regression equation showing the dependence of selected

Independent variables on the regressor

Based on the observed ( $R^2$ ) values, the multiple linear regression equation was thereafter developed using the estimated parameters and the substituted coefficients are as shown in Figures 2 and 3

which represent the soaked and unsoaked CBR. The “Cs” are the soaked CBR coefficient, while  $X_1, X_2, \dots, X_n$  are the independent variables. The values were substituted and equation (2) was derived.

$$\begin{aligned}
 CBRs = & 31.7569647842 + 0.144910171936 * X_1 + 0.204162176623 \\
 & * X_2 + 0.99823618796 * X_3 - 0.602392590978 * X_4 - 1.47629107603 \\
 & * X_5 + 25.6641130848 * X_6 - 1.38115179253 * X_7
 \end{aligned} \tag{2}$$

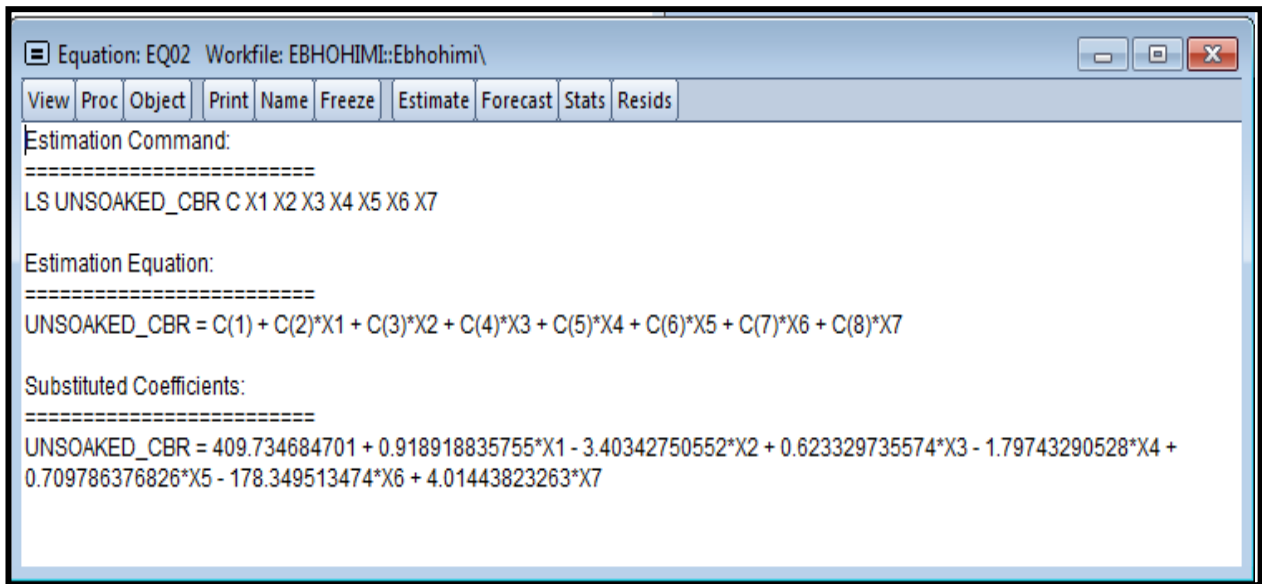

Figure 3: Multivariate linear regression equation showing the dependence of selected independent variables on the regressor

The same procedure in Figure 2 applies here. Multiple linear regression equation was developed using the estimated parameters and the substituted coefficients are as shown in Figure 3 which represent

the unsoaked CBR. The “Cs” are the soaked CBR coefficient, while X1, X2...Xn are the independent variables ( X1 = % 0.075mm sieve, X2 = % 0.425mm

sieve, X3 = LL (%), X4 = PL (%), X5= PI (%), X6 = MDD (g/cm<sup>3</sup>), X7= OMC (%)). The values were substituted and equation 3 was derived.

$$\begin{aligned}
 CBR_u = & 409.734684701 + 0.918918835755 * X1 - 3.40342750552 \\
 & * X2 + 0.623329735574 * X3 - 1.79743290528 * X4 \\
 & + 0.709786376826 * X5 - 178.349513474 * X6 + 4.01143823263 * X7
 \end{aligned}
 \tag{3}$$

Thereafter, a graphical visualization was done, the graphical representation of soaked and unsoaked CBR for Ebhohimi sample, as shown in Figures 4 and 5.

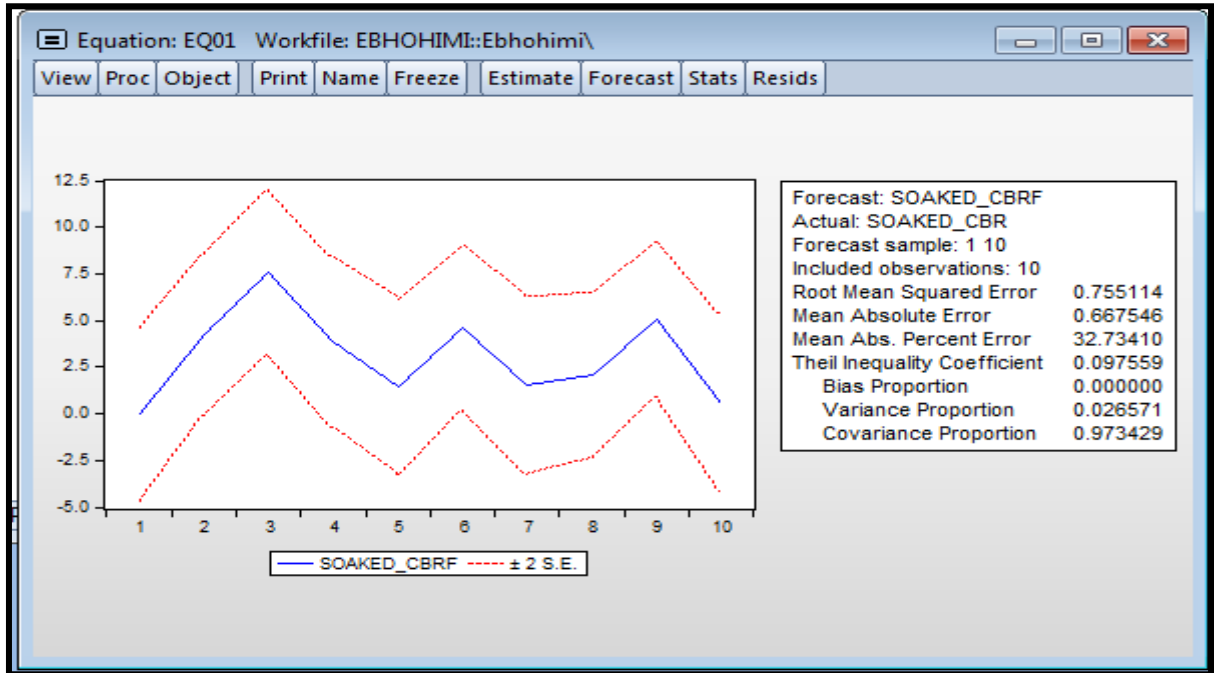

Figure 4: Statistics of fit based on 95% upper and lower bounds for soaked CBR

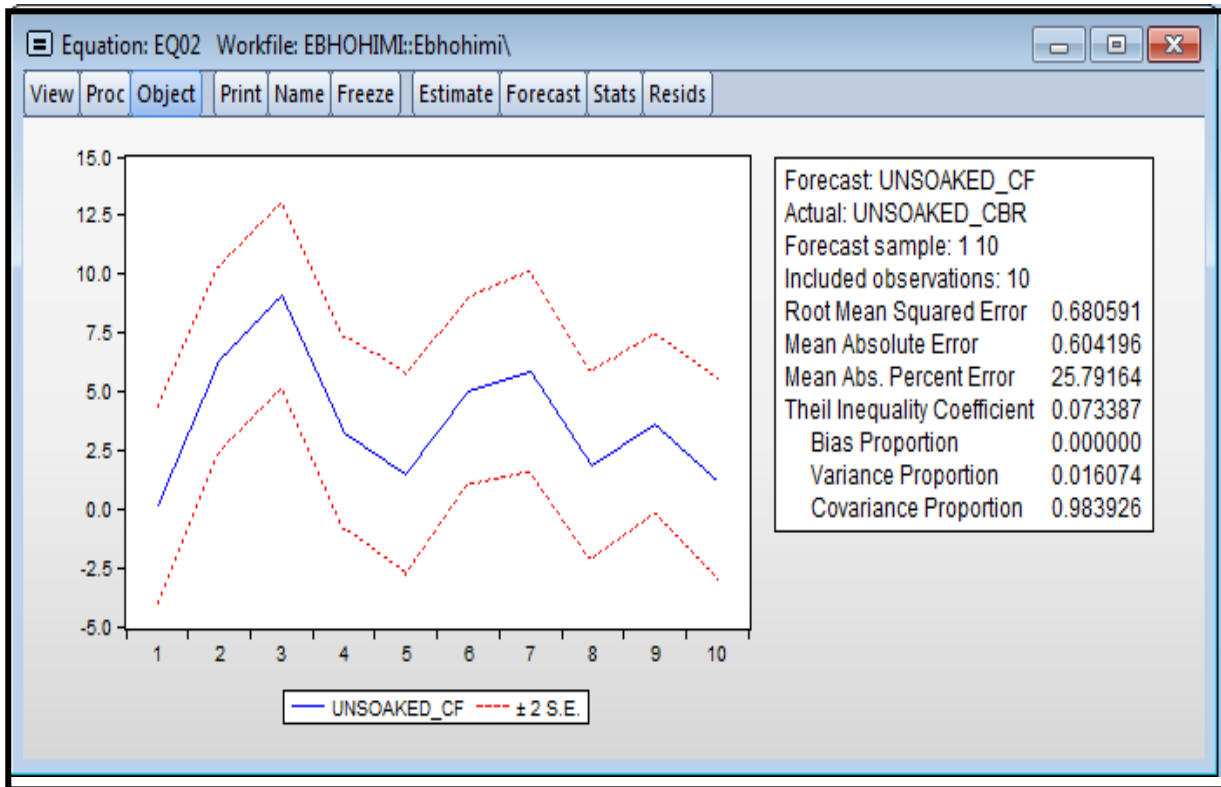

Figure 5: Statistics of fit based on 95% upper and lower bounds for unsoaked CBR

- ii. Statistics of fit based on 95% upper and lower bounds for soaked and unsoaked CBR

The computed statistics of fit based on 95% lower and upper bounds was visualized graphically as presented in Figures 4 and 5 respectively representing the effect of selected independent variables on the soaked and unsoaked CBR for Ebhohimi borrow pit soils. The red dotted lines are the upper and lower

bounds of the graph, while the blue line shows the variations in the CBR values. The selected independent variables have more effect on the unsoaked CBR than the soaked CBR. The statistical prediction Figure which shows the actual and predicted soaked and unsoaked CBR based on the multivariate regression approach is presented in Figures 6 and 7 respectively.

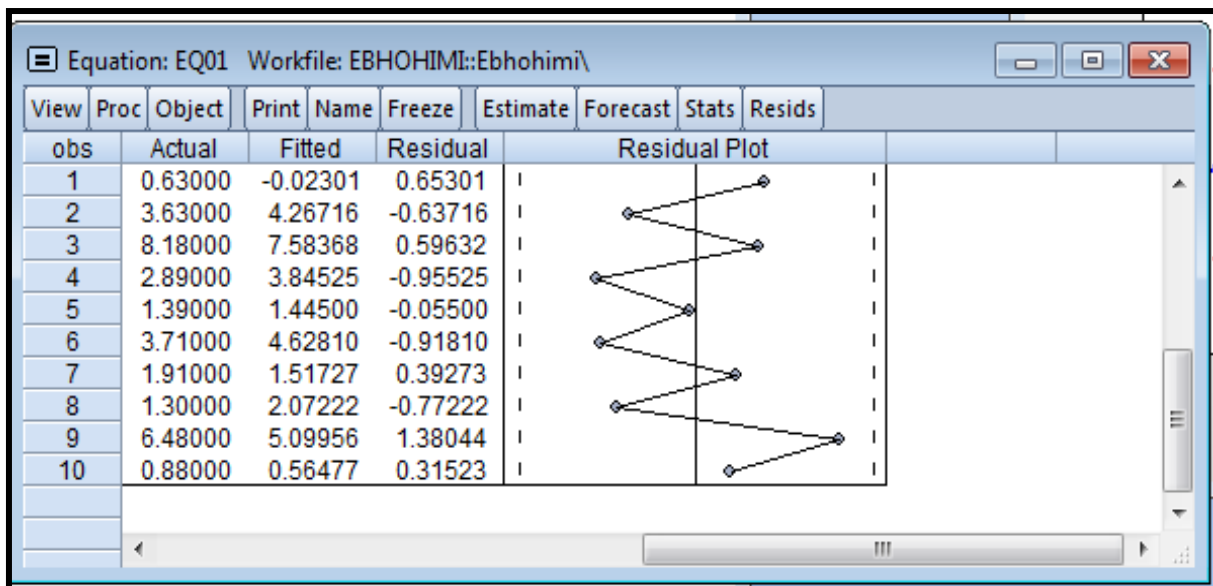

Figure 6: Actual and predicted soaked CBR

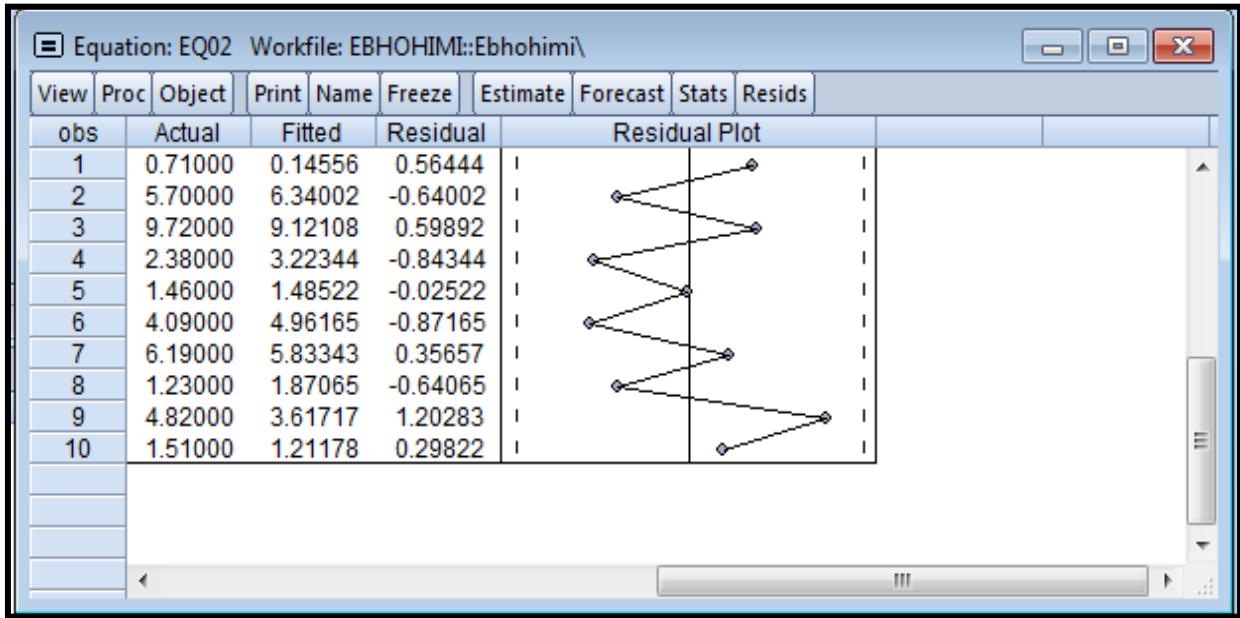

Figure 7: Actual and predicted unsoaked CBR

iii. Comparison of Actual and Predicted CBR Values

From the statistical prediction figures 6 and 7 which shows the actual and predicted soaked and unsoaked CBR based on the multivariate regression approach, it is observed that the actual CBR values and predicted CBR value for both soaked and unsoaked are relatively close, the highest variation is 1.38. To assess the strength of multivariate linear regression analysis in predicting the soaked and unsoaked CBR of the soil based on selected geotechnical parameters, a linear regression of output was done using the actual and predicted soaked and unsoaked CBR as the dependent and independent variables. Result obtained are presented in Figure 8.

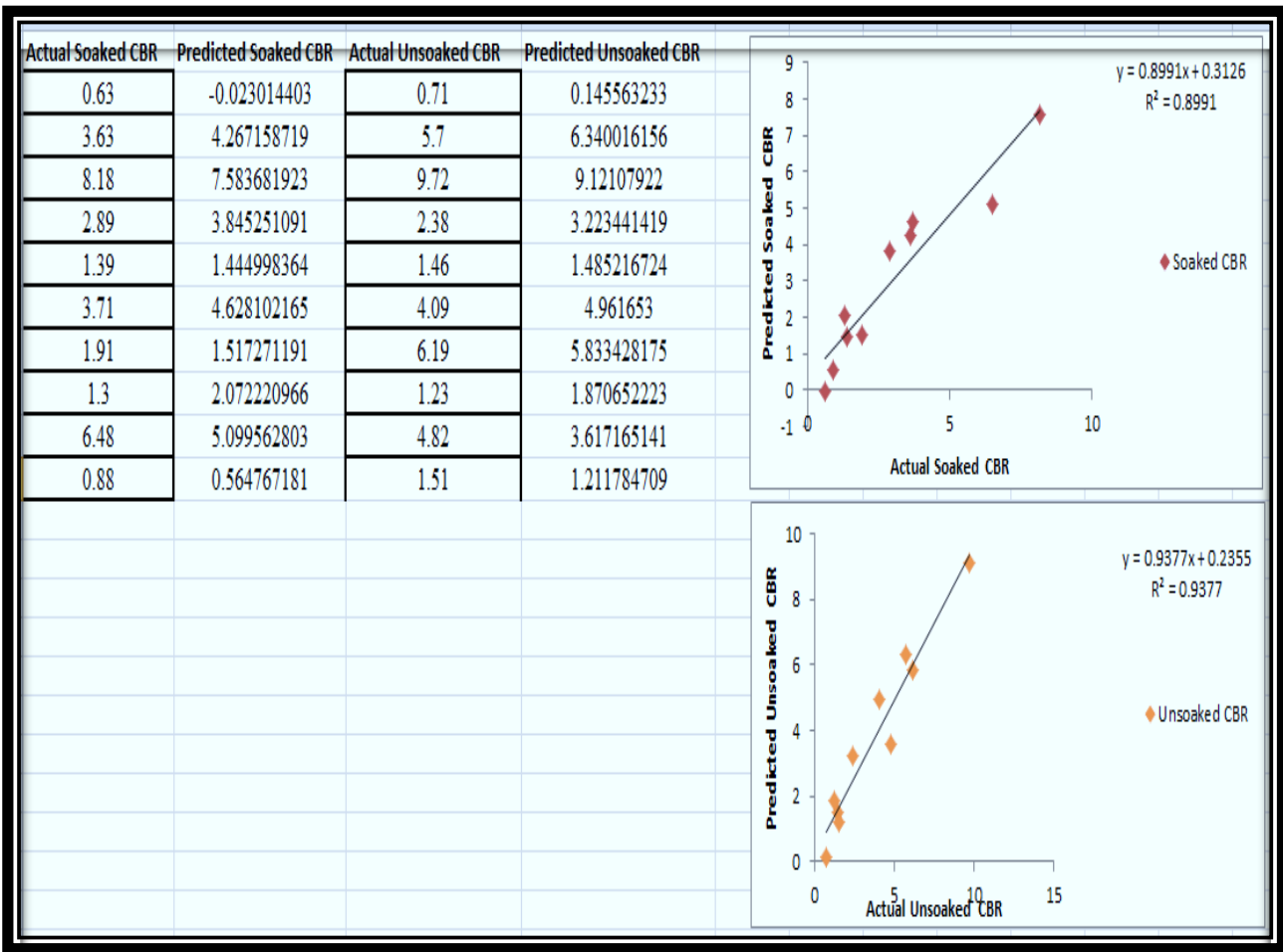

Figure 8: Prediction accuracy of multivariate linear regression (Ebhoimi)

A plot was made between experimental and predicted values of CBR as shown in Figure 8

It is clear from this figure that most of the predicted CBR values are close to the reported experimental soaked CBR values. As the Actual CBR in soaked and the unsoaked increases, predicted CBR values also increases, indicating linear relationship exists between them. Considering the square of

coefficient of correlation ( $R_2$ ) for both is found to be 0.8991 (soaked) and 0.9377 unsoaked, there is evidence that a good correlations exist.

c) *Ekpoma sample*

The input data for Ekpoma analysis is shown in Table 9.

Table 8: Input data for analysis (Ekpoma)

X1	X2	X3	X4	X5	X6	X7	SOAKED CBR	UNSOAKED CBR
36.06	68.35	53.32	19	34.32	1.59	18.6	17.6	33.2
24.32	65.85	43.81	15.86	27.95	1.62	19.38	18.2	32.49
36.89	67.99	36.74	15.51	21.23	1.78	10.8	6.34	11.4
22.15	73.16	27.76	13.43	14.33	1.69	13.2	10.9	12.8
23.14	75.49	41.52	13.7	27.55	1.72	14.9	8.85	12.8
21.13	76.44	35.76	15.18	20.58	1.76	13.6	3.48	10.2
40.44	74.7	45.8	25.2	14.29	1.59	16	8.29	10.2
40.74	78.75	33.8	19.74	14.06	1.65	14	9.03	11.1
36.23	77.43	29.38	17.45	11.92	1.71	13.6	4.99	5.09
29.35	73.32	43.81	15.86	27.95	1.62	19.4	7.43	12.67



Table 9: Software interphase showing the coefficient estimates of the dependent and independent variables

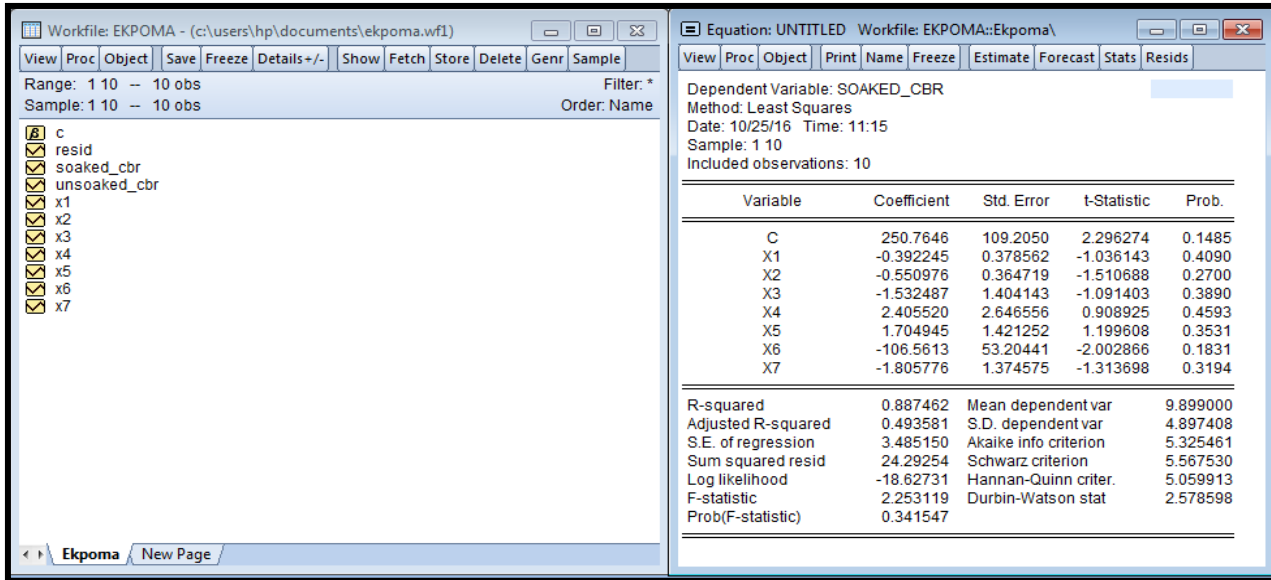
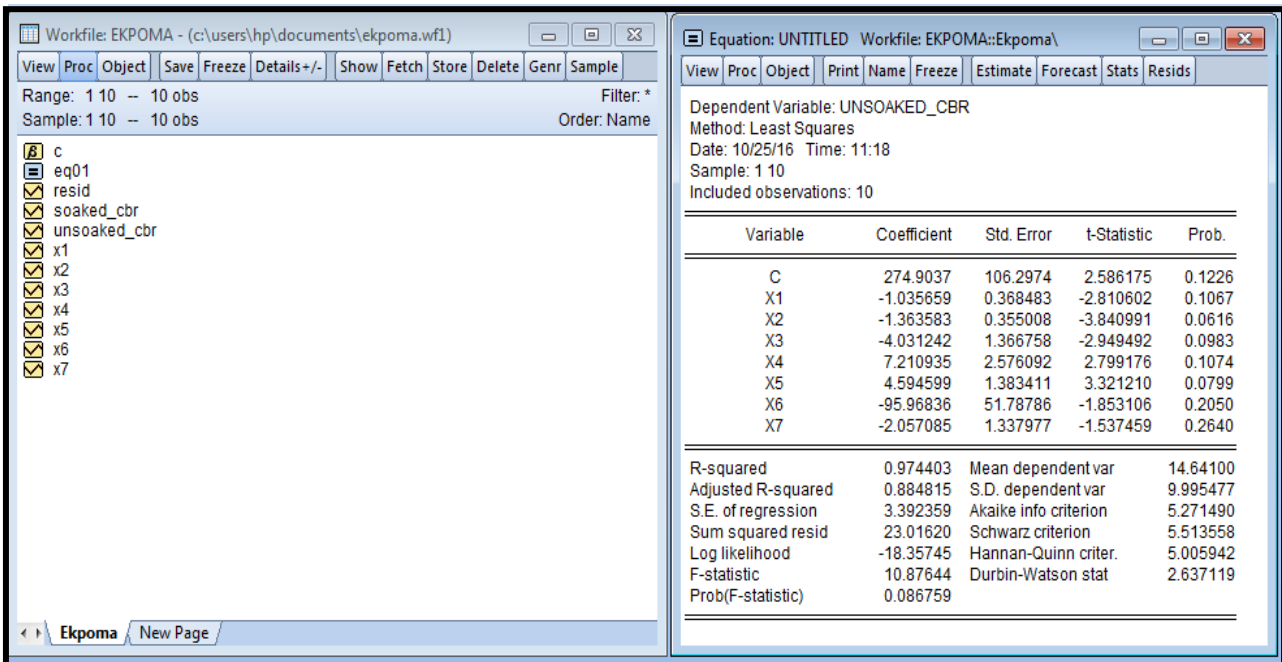

Table 10: Software interphase showing the coefficient estimates of the dependent and independent variables



d) Analysis Test Results of soaked and un-soaked CBR for Ekpoma sample

From the result of Tables 9 and 10, it was observed that the coefficient of determination ( $R^2$ ) differs for both the soaked and the unsoaked CBR analysis (0.887462 and 0.974403). The selected independent variables (percent passing 0.075mm sieve size, percent passing 0.425mm sieve size, liquid limit, plastic limit, plastic index, maximum dry density and optimum moisture content) had a better correlation with the unsoaked CBR than the soaked CBR. In addition, the

high coefficient of determination as observed revealed the suitability of multivariate linear regression model in explaining the dependence of the independent variables on the regressor. From the results, it was observed that 88.7462% and 97.4403% of the variation in the soaked and unsoaked CBR can be explained by the selected independent variables. Thereafter, multivariate linear regression equation was developed as are shown in Figures 9 and 10 and

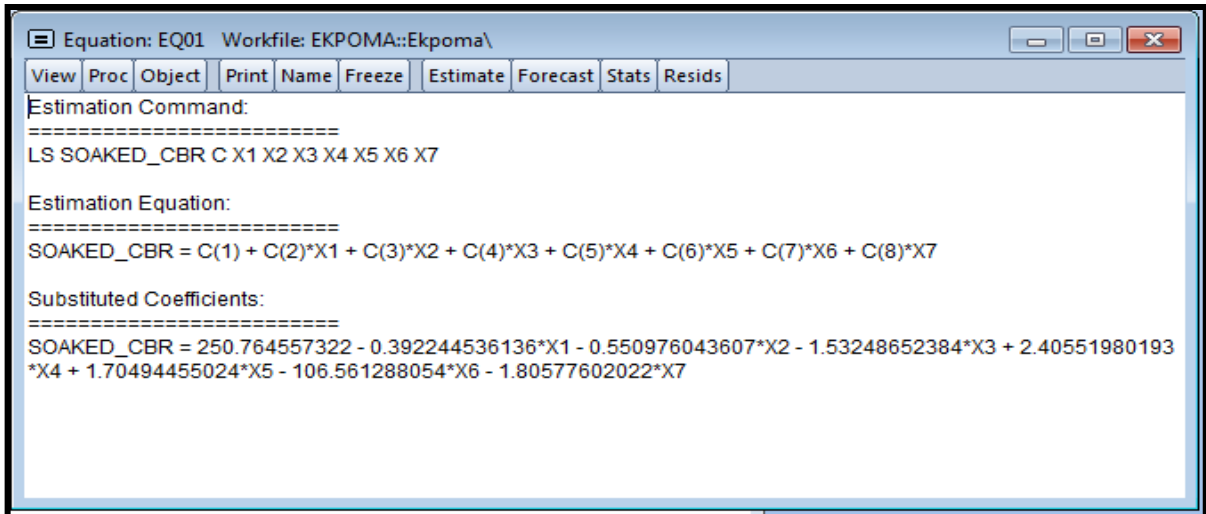

Figure 9: Multivariate linear regression equation showing the dependence of selected independent variables on the regressor

$$\begin{aligned}
 CBRs = & 250.764557322 - 0.392244536136 * X1 - 0.550976043607 * X2 \\
 & 1.53248652384 * X3 + 2.40551980193 * X4 + 1.70494455024 * X5 \\
 & - 106.561288054 * X6 - 1.80577602022 * X7
 \end{aligned}
 \tag{4}$$

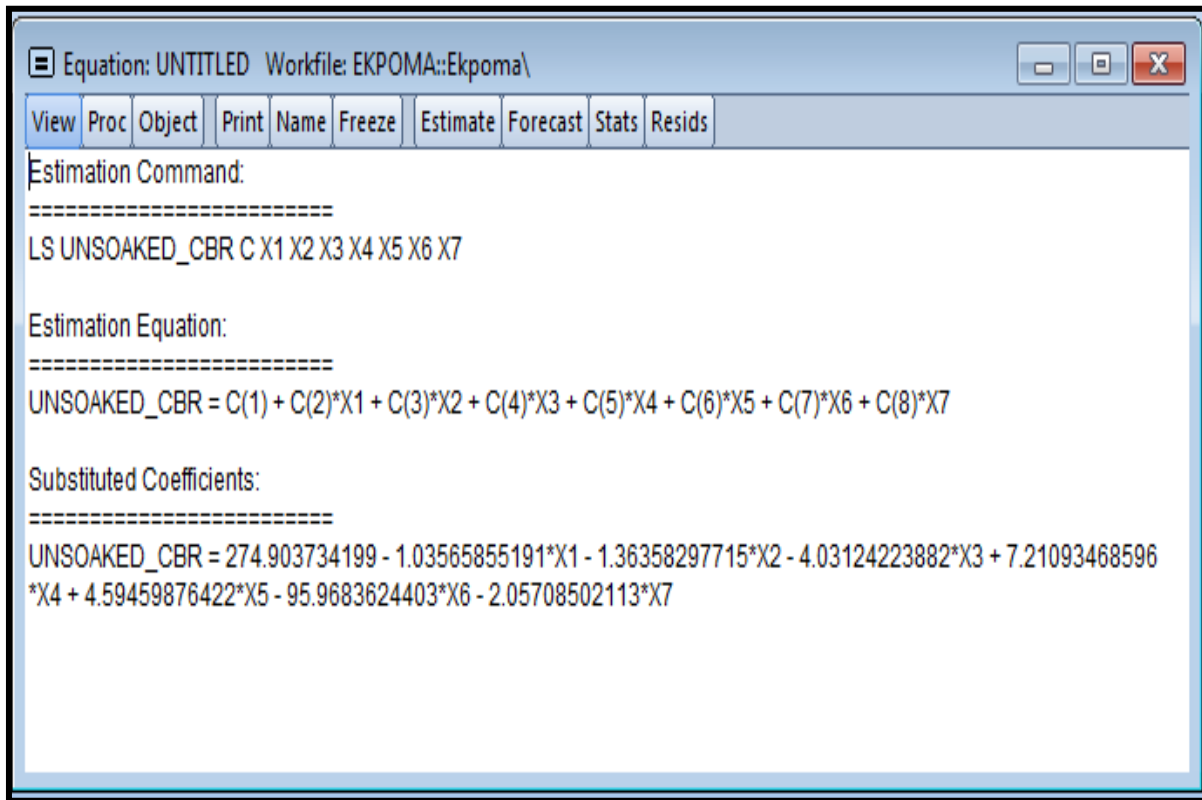

Figure 10: Multivariate linear regression equation showing the dependence of selected independent variables on the regressor

$$\begin{aligned}
 CBR_u &= 274.903734199 - 1.03565855191 * X1 - 1.36358297715 \\
 &* X2 - 4.03124223882 * X3 + 7.21093468596 * X4 + 4.59459876422 \\
 &* X5 - 95.9683624403 * X6 - 2.05708502113 * X7
 \end{aligned}
 \tag{5}$$

Based on the observed ( $R^2$ ) values, the multiple linear regression equation was thereafter developed using the estimated parameters and the substituted coefficients as shown in Figures 9 and 10 which represent the soaked and unsoaked CBR models.

The graphical representation of the predicted values of soaked and unsoaked CBR for Ekpoma sample, are as shown in Figures 11 and 12.

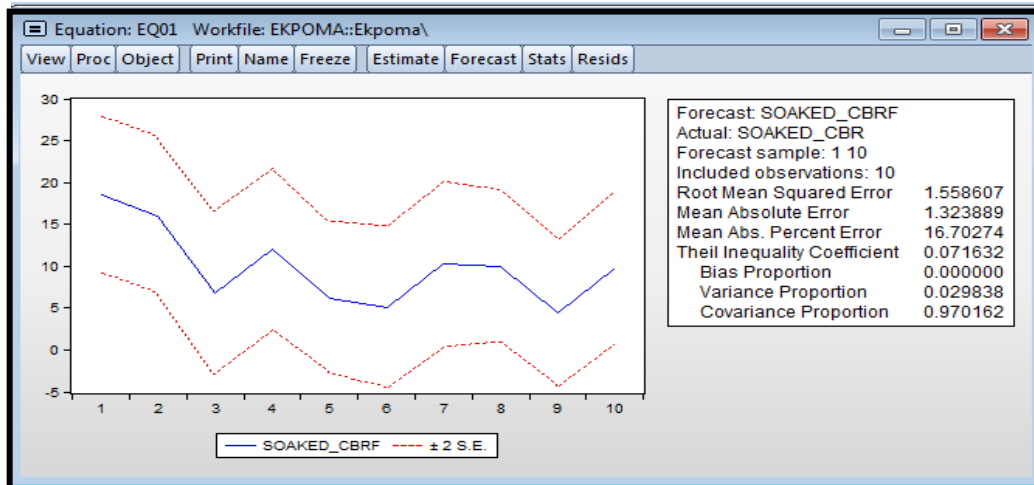

Figure 11: Statistics of fit based on 95% upper and lower bounds for soaked CBR

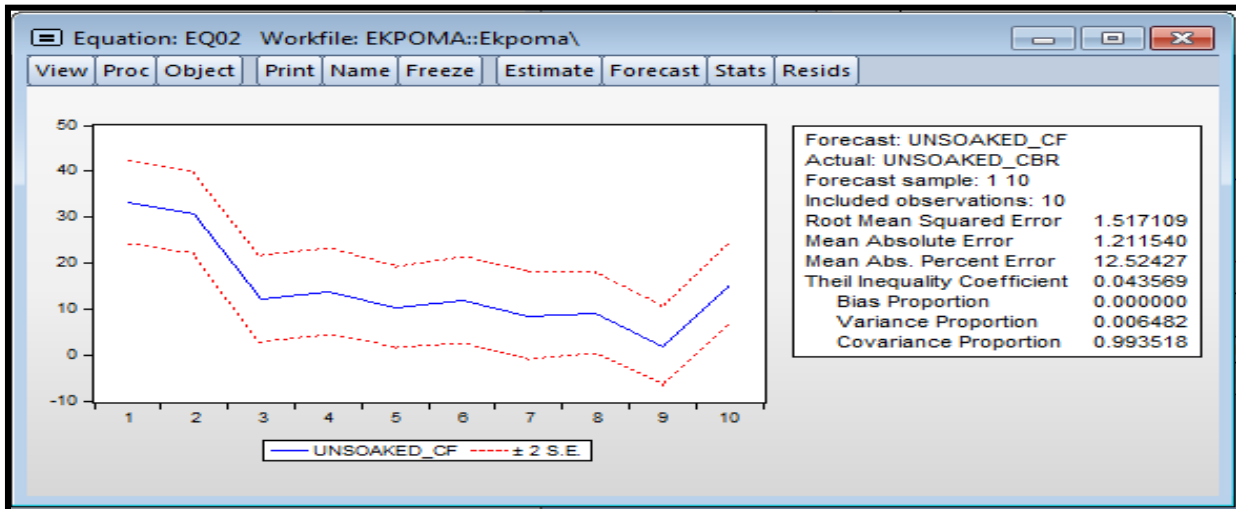

Figure 12: Statistics of fit based on 95% upper and lower bounds for unsoaked CBR

e) Statistics of fit based on 95% upper and lower bounds for soaked and unsoaked CBR

The computed statistics of fit based on 95% lower and upper bounds was visualized graphically as presented in figures 11 and 12 respectively representing the effect of selected independent variables on the soaked and unsoaked CBR for Ekpoma. The red dotted lines are the upper and lower bound of the graph, while the blue line is the CBR value. Viewing the soaked and the unsoaked CBR lines, the independent variables (LL,

PL, PI, OMC, MDD, % passing of 0.075mm and 0.425mm sieve) have more effect on the soaked CBR than the unsoaked CBR values.

The statistical prediction table which shows the actual and predicted soaked and un-soaked CBR based on the multivariate regression approach is presented in figures 13 and 14 respectively.

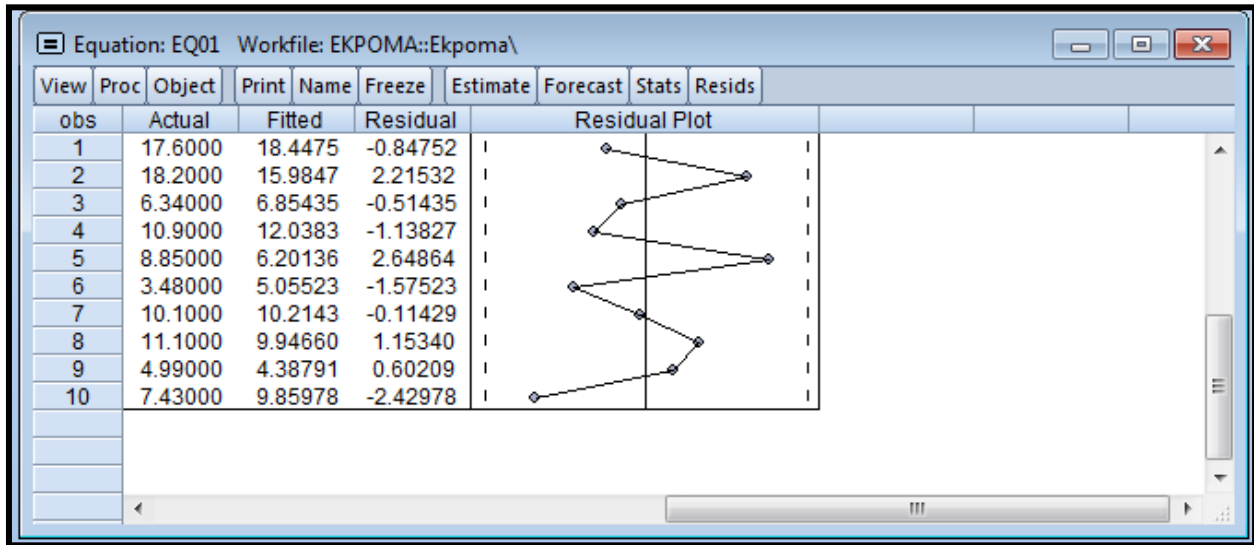

Figure 13: Actual and predicted soaked CBR

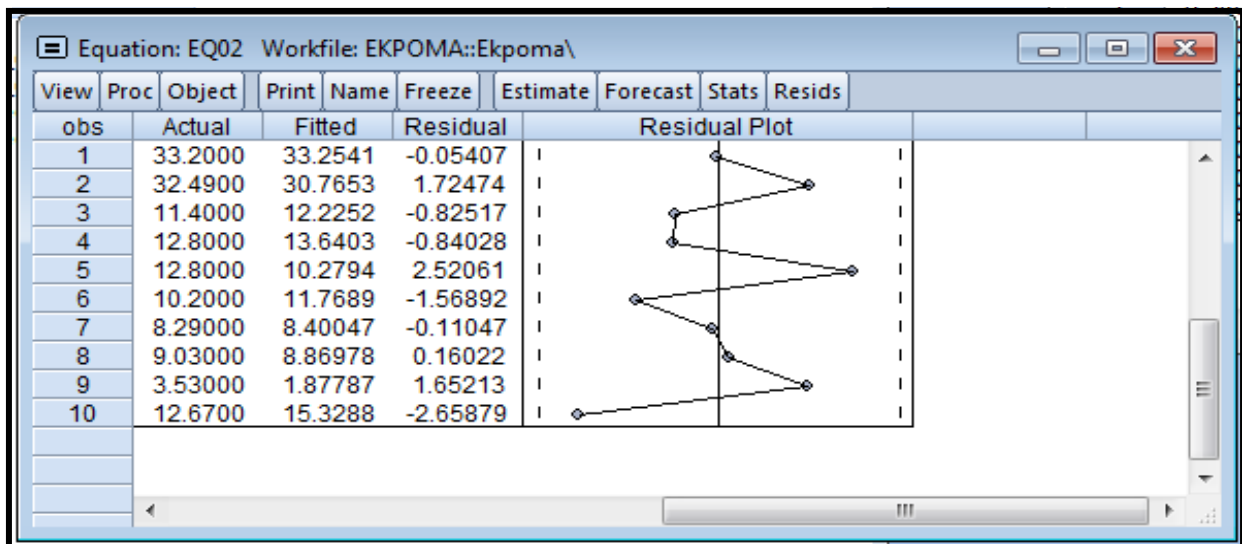

Figure 14: Actual and predicted un-soaked CBR

f) *Statistical Prediction of Actual and Predicted CBR soaked and unsoaked*

The statistical prediction table which shows the actual and predicted soaked and un-soaked CBR based on the multivariate regression approach is presented in Figures 13 and 14 respectively. To assess the strength of multivariate linear regression analysis in predicting the soaked and unsoaked CBR of the soil based on selected geotechnical parameters, a linear regression of output was done using the actual and predicted soaked and unsoaked CBR as the dependent and independent variables. Result obtained is presented in Figure 15

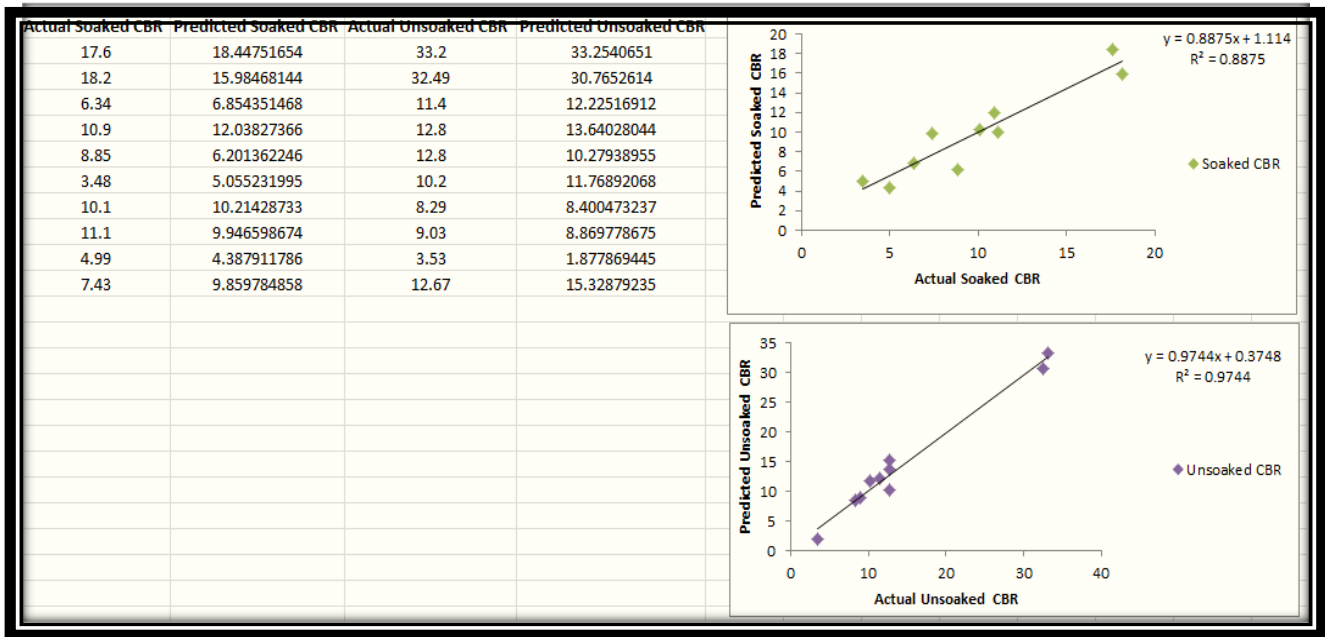

Figure 15: Prediction accuracy of multivariate linear regression for both soaked and un-soaked CBR (Ekpoma) sample

A plot was made between experimental and predicted values of CBR as shown in Figure 15. It is clear from this figure that most of the predicted CBR values are close to the reported experimental soaked CBR values and hence considering the limitations of developed correlation and the test related errors, the proposed equations can be regarded as well validated.

It is observed from figure 15 that the experimental soaked CBR values are close to predicted values. The model developed for soaked CBR value has correlation coefficient ( $R^2$ ) = 0.8875 and  $R^2 = 0.9744$  for the unsoaked indicating a reasonable fit.

Table 11: Statistical parameters of cross validation output data

Location	Model (Y)	$R^2$	Adjusted $R^2$	Standard Deviation ( $\sigma$ )	Standard Error (SE)	Mean ( $\mu$ )
Ebhohimi CBRs	$0.8991 X + 0.3126$	0.8991	0.5461	2.5063	1.6884	3.1000
Ebhohimi CBRu	$0.9377 X + 0.2355$	0.9377	0.7197	2.8747	1.5218	3.7810
Ekpoma CBRs	$0.8875 X + 1.114$	0.8874	0.4935	4.8974	3.4851	9.8990
Ekpoma CBRu	$0.9744 X + 0.3748$	0.9744	0.8848	9.9954	3.3923	14.641

Statistical parameters such as coefficient of multiple determinations ( $R^2$ ), standard deviation ( $\sigma$ ), standard error (SE), Adjusted  $R^2$ , and mean ( $\mu$ ) of estimated and measured values obtained after multivariate analysis were determined for both soaked and unsoaked CBR for Ebhohimi and, Ekpoma. Comparing the soaked and unsoaked CBR values of these two locations, it was observed in Table 11, that Ekpoma sample has a higher determination coefficient

( $R^2$ ) of 0.9744 for unsoaked CBR as a function of independent variables (LL, PI, MDD, OMC, 0.075mm and 0.425mm sieve) and Ebhohimi sample has a higher determination coefficient ( $R^2$ ) of 0.8991 for soaked CBR, which is also as a function of the independent variables. This means that the model has a higher coefficient of determination compared with un-soaked CBR.

Table 12: Summary of the experimental and predicted CBR soaked and unsoaked

Ebhohimi	Sample No.	BP1	BP2	BP3	BP4	BP5	BP6	BP7	BP8	BP9	BP10
	Experimental Value of CBRs	0.63	3.63	8.18	2.38	1.39	3.71	1.91	1.30	4.82	0.88
	Predicted value of CBRs	0.02	4.26	7.58	3.84	1.44	4.62	1.51	2.07	5.09	0.56
Experimental Value of CBRu	0.71	5.70	9.72	2.89	1.46	4.09	6.19	1.23	6.48	1.51	

	Predicted value of CBRu	0.14	6.34	9.12	3.22	1.48	4.96	5.83	1.87	3.61	1.21
Ekpoma	<b>Sample No.</b>	<b>RD1</b>	<b>RD2</b>	<b>BP3</b>	<b>BP4</b>	<b>BP5</b>	<b>BP6</b>	<b>RD7</b>	<b>RD8</b>	<b>RD9</b>	<b>RD10</b>
	Experimental Value of CBRs	17.6	18.2	6.34	10.9	8.85	3.48	8.29	9.03	4.99	7.43
	Predicted value of CBRs	18.4	15.9	6.85	12.0	6.20	5.05	10.2	9.94	4.38	9.85
	Experimental Value of CBRu	33.2	32.4	11.4	12.8	12.8	10.2	10.1	11.1	5.09	12.6
	Predicted value of CBRu	33.2	30.7	12.2	13.6	10.2	11.7	8.40	8.86	1.87	15.3

#### IV. CONCLUSION

From this study, it was observed that the regression model was able to capture the relation between index properties of soils and the soaked and unsoaked CBRs. At Ebhohimi site, the coefficient of regression with values predicted from the developed regression model and experimentally obtained values were found to be high (Soaked was observed to be 0.89 and the unsoaked is 0.93). Ekpoma ( $R^2$ ) was observed to be 0.88 for the soaked and 0.97 for the unsoaked.

The results of the analysis indicate that there is a close relationship between experimental CBR values and the predicted CBR values.

However, the results show that more than half of the sample materials do not satisfy the requirement for both road base and subbase. Some of the materials can only be used as subgrade materials only after thorough compaction by several passes with vibratory roller or excavation and replacement with suitable fill material has been carried out.

#### REFERENCES RÉFÉRENCES REFERENCIAS

- Arora, K. R., (2004) *Soil Mechanics and Foundation Engineering*, Re-print Standard Publishers Distributer, Nai Sarak, Delhi, 2004.
- Alayaki, F. M. (2012). Water Absorption Properties of Lateritic Soil in Road Pavement. A Case Study of Ife-Ilesha Highway, South-Western Nigeria. *International Journal of Emerging Technology and Advanced Engineering*. p. 52.
- American Society for Testing and Materials, (2000). Standard Practice for classification of Soils for Engineering Purposes (Unified Soil Classification System). Annual Book of ASTM Standards, West Conshohocken, Pennsylvania, Volume 04.08.
- Bello, A.A. (2012). Regression analysis between properties of subgrade lateritic soil. *Leonardo Journal of sciences*, 21, pp. 99-108.
- BSI (British Standard Institution) (1990). Methods of test for soils for civil engineering purposes. Part 2 (BS 1377-2) and Part 4 (BS 1377-4): BS 1377 Tests 2 and 3, BS, London.
- Carter, M. and Bentley, S.P. (1991). *Correlations of soil properties*. Pentech Press, London, p. 130.
- Croney, D. (1977). "The design and performance of road pavements". (Department of the Environment. Department of Transport: Transport and Road Research Laboratory)
- Her Majesty's Stationery Office, London, 673pp.
- Kumar, T. (2014). "A Study of Correlation between California Bearing Ratio (CBR) values with other properties of Soil". *International Journal of Emerging Technology and Advanced Engineering Certified Journal*, Civil Engineering Department, Nowgong Polytechnic, Nagaon, Assam, India.
- Federal Ministry of Works and Housing (1994). General Specification for Roads and Bridges.
- Forckenbrock, D.J and GLEN E. Weisbrod, G.E (2001) NCHRP PROGRAM REPORT 456, Guidebook for Assessing the Social and Economic Effects of Transportation Projects, NATIONAL ACADEMY PRESS WASHINGTON, D.C
- National Cooperative Highway Research Program (2001). "Correlation of CBR Values with Soil Index Guide for Mechanistic and Empirical Design for New and Rehabilitated
- Pavement Structures". Final Document. In: Properties. West University Avenue Champaign, Illinois: Ara, In.
- Okovido, .J. O., and Musa .M. (2004). "Civil Engineering History & Phylosophy of Science & Technology". Quality Press Research Studio, Benin City.
- Orie, O. U. and Nweni, E. L. (2015). Severity indices of variables causing road collapse in Nigeria. *Journal of Civil and Environmental System Engineering*, University of Benin Volume 13, Pp 156.
- Sathawara Jigar K. and Patel A. K. 2013. "Comparison between soaked and unsoaked CBR". *International Journal of Advanced Engineering Research and Studies*. Volume 11, pp 1327-135.





This page is intentionally left blank



GLOBAL JOURNAL OF RESEARCHES IN ENGINEERING: E  
CIVIL AND STRUCTURAL ENGINEERING  
Volume 19 Issue 4 Version 1.0 Year 2019  
Type: Double Blind Peer Reviewed International Research Journal  
Publisher: Global Journals  
Online ISSN: 2249-4596 & Print ISSN: 0975-5861

# Effectiveness of Characteristic Model of Traffic Flows in Simpang 4 Road Bireun (Comparison with Greenshield, Greenberg, Underwood) Methods

By Adzuha Desmi & Riza Yanti

*Malikussaleh University*

**Abstract-** Characteristics of the traffic flow are studied and analyzed using several methods. This study aims to analyze the comparison of traffic characteristic model on Simpang 4 Bireun road using MKJI 1997 method, and to compare with Greenshield, Greenberg and Underwood models. The effectiveness and efficiency of the data presentation presented by each method. The results of the mathematical model for Greenshield Model are  $(S) = 40.6231$  km/hr, Greenberg  $(S) = 37.92$  km/hr and Underwood  $(S) = 40.668$  km/hr. For the relationship of density velocity, Greenberg has a better approach, whereas for the density volume relationship, they show almost the same result, and for the volume velocity relationship, the Greenshield and Underwood approaches are still better.

**Keywords:** greenshield, greenberg, underwood, speed vehicles, traffic flow, density of traffic.

**GJRE-E Classification:** FOR Code: 870301



*Strictly as per the compliance and regulations of:*



© 2019. Adzuha Desmi & Riza Yanti. This is a research/review paper, distributed under the terms of the Creative Commons Attribution-Noncommercial 3.0 Unported License (<http://creativecommons.org/licenses/by-nc/3.0/>), permitting all non commercial use, distribution, and reproduction in any medium, provided the original work is properly cited.

# Effectiveness of Characteristic Model of Traffic Flows in Simpang 4 Road Bireun (Comparison with Greenshield, Greenberg, Underwood) Methods

Adzuha Desmi<sup>α</sup> & Riza Yanti<sup>σ</sup>

**Abstract** - Characteristics of the traffic flow are studied and analyzed using several methods. This study aims to analyze the comparison of traffic characteristic model on Simpang 4 Bireun road using MKJI 1997 method, and to compare with Greenshield, Greenberg and Underwood models. The effectiveness and efficiency of the data presentation presented by each method. The results of the mathematical model for Greenshield Model are  $(S) = 40.6231$  km/hr, Greenberg  $(S) = 37.92$  km/hr and Underwood  $(S) = 40.668$  km/hr. For the relationship of density velocity, Greenberg has a better approach, whereas for the density volume relationship, they show almost the same result, and for the volume velocity relationship, the Greenshield and Underwood approaches are still better.

**Keywords:** greenshield, greenberg, underwood, speed vehicles, traffic flow, density of traffic.

## I. INTRODUCTION

The construction of roads as a form of government commitment in developing infrastructure as a whole is intended as a provider of transportation facilities that facilitate local communities to interact with their surrounding environment, both in the social, economic and cultural fields. As one of the means of land transportation. Roads are intended to be used as an accumulation of various motorized vehicles and non-motorized vehicles. And in this case the number or volume of vehicles crossing the road depends on various parameters including population density, number of vehicles and road conditions.

Simpang 4 highway Bireun is one of the arterial roads in the city of Bireun which has a fairly high volume of vehicles, especially during the school season, where this highway has thousands of students and a row of shops along the road. This dynamic road condition creates vulnerability in the form of traffic jams through the road. The number of movements in Bireun can be related to the density of traffic flow on the road. Density can be believed to correlate with the speed of the vehicle and the volume of vehicles that occur on the road.

**Author α σ:** Civil Engineering Department, Faculty of Engineering, Malikussaleh University, emails: adz.desmi@gmail.com, riza.yanti@gmail.com

By looking at the background, some problems can be raised, namely; what is the shape of the mathematical model of the characteristics of the Bireun 4 intersection. what is the minimum speed that must be taken by a road user who crosses the highway 4 intersection Bireun, and which model is the most optimal that can describe the real conditions of the characteristics of the road segment.

The objectives of this study are to find out the mathematical model between speed - density, volume-speed and volume-density must be carried out by highway intersection 4 Bireun, know the minimum speed and optimal speed of the vehicle traveling on the road, and Know the Greenshield Model, Greenberg and Underwood models.

This research is intended to find a correlation model between vehicle volume, current and vehicle speed on the road. The road section studied at the Bireun 4 intersection area, this election is based on preliminary observations where traffic congestion often occurs, the volume of vehicles increases at certain hours. And there has not been a study that has modeled the correlation of current and density on this road segment.

## II. RESEARCH METHODS

This research includes preparation, field data collection, then preparations are made in the form of making the initial and final boundaries on the Bireun 4 intersection, and a good bounding mark for 100 m can be seen by the observer where the mark is made using color paint the red applied to the places seen by the observer.

The research location was carried out at the Medan-Banda Aceh crossing, Banda Aceh Medan road, Bireuen-Takengon road, Kuala Raja Bireuen road, can be seen on the location map below.

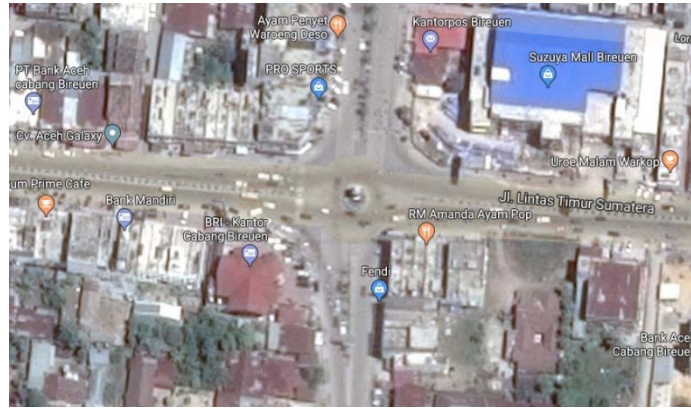

Source: Google Earth

Figure 2.1: Map of location

a) Data Collection

Primary data collection is in the form of traffic volume, light vehicle speed, carried out simultaneously at the research location on Simpang 4 Bireuen road. for 4 days from 7:00 a.m. until 18:00 a.m. Whereas the geometric data collection in the form of the width of the traffic lane (m), the width of the entrance to the main road m), the kereb, the distance of the road (m) were carried out at night so as not to interfere with traffic activities during the study.

The method of data collection in this study is primary and secondary data. Primary data obtained from field surveys in the form of traffic volume, traffic speed, vehicle travel time and geometric measurements of the road, from the data will then be processed to obtain traffic density data. Secondary data as a complement to supporting data in the field includes a road network map of the intersection of 4 Bireuen cities obtained from relevant agencies, such as the Public Works Agency, Transportation Agency, Statistics agencies and sketches of the observation locations on the reviewed roads.

Traffic volume is the number of vehicles that pass a point on a road segment within a certain time interval stated in a unit vehicle at a certain time the average traffic volume is an average vehicle calculated according to a certain unit of time, can daily be said as a volume average daily traffic / LHR or in English is referred to as Average Daily Traffic Volume (ADT). According to Morlok, (1988), the volume of traffic can be calculated using the following formula:

$$q = \frac{n}{t} \quad (2.1)$$

where q = Volume of traffic passing through a point, n = Number of vehicles passing through that point in the observation time interval, t = Observation time interval.

The traffic flow parameters are divided into 2 categories; (a). The macroscopic parameter: characterizes the overall traffic flow, (b). Microscopic parameters: characterize the individual behavior of

vehicles that give each other traffic opportunities to each other.

Macroscopically, the traffic flow is described/characterized by 3 main parameters; (a). Volume or current level (volume or rate of flow). (b). Speed (speed), (c). Density. In addition, headway (h), spacing (s), and occupancy (R) parameters were also used. Regarding the headway and spacing, there are parameters of clearance (c) and gap (g).

Local speed observation is done on a number of vehicles. This is based on the inequality of the speed of each vehicle by the influence of various conditions, both vehicles, drivers, instantaneous density and so on. Therefore, to obtain local speed, simplified statistical procedures are used.

Speed describes the level of movement of a vehicle expressed in the distance of the unit of time or the value of changing distance to time. The unit is kilometers/hour, meters/second. According to Tamin O. Z., (1991) speed is defined as the distance that can be taken by a vehicle of time unity. The unit commonly used is meters / seconds or kilometers / hour. The formula for calculating speed (Morlok, E.K. 1988) :

$$V = \frac{d}{t} \quad (2.2)$$

Where ; V = Speed (km/h, m/sec), d = Distance (km, m), t = Travel time (hours, seconds).

There are 3 classifications of speed in traffic; (a). Point / moment speed (spot speed), the condition where the vehicle experiences a steady speed at a point, (b). Travel speed (journey speed), the average speed where the value can be determined from the distance traveled divided by the total travel time, (c). Moving speed (running speed), the average speed of a vehicle to cross a certain distance in the condition of the vehicle still running, i.e. the condition after being reduced by the time the obstacle occurs (eg obstacles at the intersection). This moving speed can be determined from the distance traveled divided by total travel time which has been reduced by the time of

stopping due to obstacles caused by disturbances that occur in traffic.

To find out the value of traffic density obtained from data processing volume and speed of traffic, namely from the results of a comparison between the volume value with the speed of traffic at the same time of observation. The value of traffic density is expressed in smp (the passenger car unit is a traffic flow unit)/km.

The passenger car unit is a traffic flow unit, where flows from various types of vehicles have been converted into light vehicles (including passenger cars) using passenger car equivalence (EMP) (Ririn Gamran, et all 1997). This use is intended to make traffic analysis

easy to do with the factors of passenger car units (pcu) of each motorized vehicle according to the Indonesian Road Capacity manual (MKJI 1997), for urban roads are as follows: (a). Vehicle Weight (HV) = 1.30, (b). Light Vehicle (LV) = 1.00, (c). Motorcycle (MC) = 0.40, (d). Non-motorized vehicle = 1.00

b) Relationship Between Speed, Density and Traffic Volume

The relationship between speed, volume and density can be graphically illustrated as shown in the following figure.

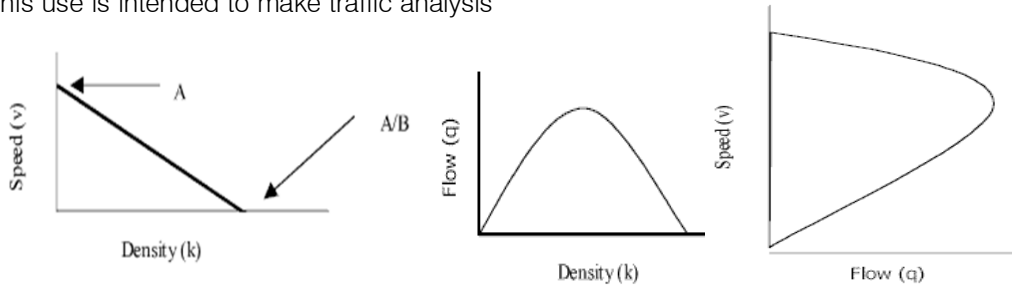

(Source : McShane dan Roes, 1990)

Figure 2.2: Relationship between speed, flow and density

From the curve, it can be seen that the basic relationship between volume and speed is that with increasing volume of traffic, the average speed of the road will decrease until the maximum volume is reached (Ririn Gamran, et all 1997). The relationship between speed and density shows that the speed will decrease if the density increases. The relationship between volume and density shows that density will increase if the volume also increases.

linear (Tamin O.Z, 2000) as stated in equation (2.2). This model is the earliest model recorded in an effort to observe the behavior of traffic flows. Greenshields get the result that the relationship between speed and density takes the form of a linear curve (McShane and Roes, 1990).

The speed at which the maximum volume is obtained by using the equation:

i. Greenshield Model

Greenshield formulates that the mathematical relationship between speed-density is assumed to be

$$V_s = V_m = \frac{V_f}{2} \tag{2.3}$$

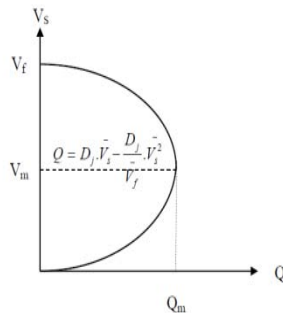

Figure 2.3: Relationship between speed and volume

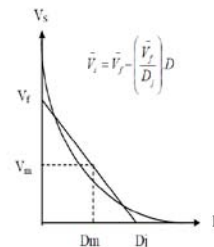

Figure 2.4: Relationship between speed and density

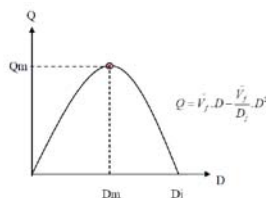

Figure 2.5: Relationship of current and density

ii. *Greenberg Model*

To analyze the relationship between the variables of volume and speed and density according to Greenberg, the following equations are used :

The relationship between Volume and Speed on the Greenberg model uses the following equations :

$$Q = V_s \cdot D_j \cdot \exp \frac{-V_s}{V_m} \tag{2.4}$$

This Volume and Density Relationship applies the following equation :

$$Q = V_m \cdot D \cdot L_n \frac{D_j}{D} \tag{2.5}$$

$$Q_{maks} = \frac{D_j \cdot V_m}{e} = V_m \cdot D_m \tag{2.6}$$

Speed when maximum volume is obtained :

$$V_s = V_m \tag{2.7}$$

iii. *Underwood models*

To get the relationship between the volume, speed and density variables according to the Underwood exponential model, the relationship between the volume and speed of the Underwood model is used as follows :

$$Q = V_f \cdot D_m \cdot Ln \left( \frac{V_f}{V_s} \right) \tag{2.8}$$

The volume and density relationship applies the following equation :

$$Q = D \cdot V_f \cdot \exp \left( \frac{-D}{D_m} \right) \tag{2.9}$$

The maximum volume (Qmaks) is :

$$Q_{maks} = \frac{D_m \cdot V_f}{\exp} \tag{2.10}$$

The speed at maximum volume (Qmaks) is obtained by using the equation :

$$V_m = \frac{V_f}{\exp} \tag{2.11}$$

c) *Relationship Analysis*

According to Riyanto B, (2003), the relationship between the three variables of speed, density and volume is arranged based on the data of traffic flow and speed of vehicles taken every 5 minute period arranged in a list in pairs then the density value can be searched by the basic equation  $V = D \cdot US$ . The relationship between speed (US), density (D) and current (V), was analyzed using three methods namely the Greenshield, Greenberg and Underwood methods. Completion of statistics is approached by finding the relationship between speed and density through *regression methods*.

The relationship between speed and density respectively with the Greenshield, Greenberg and Underwood methods is as follows :

a. *Greenshield* :  $U_s = U_f - \left( \frac{U_f}{D_j} \right) \cdot D$  (2.12)

b. *Greenberg* :  $U_s = U_m \cdot Ln \left( \frac{D_j}{D} \right)$  (2.13)

c. *Underwood* :  $U_s = U_f \cdot e^{-\frac{D}{D_m}}$  (2.14)

d) *Research Road Map and Comparison Between These Researches with Previous Research*

Tabel 2.1: Road map penelitian dan penelitian sebelumnya.

Jurnal	Roux J., 2002	Tamin Z .O., 1992	Mashuri, 2006	Julianto N. E., 2010	Gregory K. L., 2012	Jun J., 2012	Yuniar D., 2013	Iskandar H., 2012
Road Type	Tol	Arteri	Arteri	Arteri	Arteri	Tol	Arteri	Tol
Location	Cape Town	Jakarta	Palu	Semarang	Iloilo	Virginia Utara	Kalimantan	Bandung
Method	Greenberg	Underwood	Greenshield	Underwood	JICA STRADA	-	Greenshield	MKJI 1997

Source: Results of Research Recap



Based on the table above which can be taken to be used as references in this study are as follows :

- a. Mashuri, (2006) conducted a study on the density of traffic flow on arterial roads in Palu. This study discusses the relationship of the parameters of speed, volume and density using the Greenshield method.
- b. Tamin Z. O., (1991) conducted a study of the relationship between speed and volume of traffic on Jalan H.R. Rasuna Said, Jakarta. This study discusses the relationship of the parameters of speed, volume and density using the Underwood method.
- c. Julianto N. O., (2010) conducted a study on the relationship between speed and volume of traffic on the Semarang road segment. This study discusses the relationship of the parameters of speed, volume and density using the Underwood method.

The difference between the three studies above with the research that the author will discuss is that the location of the research road that will be carried out is not an arterial road but the chosen road is a toll road which does not have large side barriers and a higher speed capacity difference. Then the velocity and volume data will be used to calculate the vehicle density during the peak hour period using the basis of MKJI calculation, 1997. From the processed data, a graph of the relationship between speed and density will be made and then the optimum speed velocity value will be obtained. meeting.

e) *Transportation*

In general, the definition of transportation is the transfer of people or goods from one place to another by using a vehicle driven by humans or machines (Nasution, 2004). Transportation can be said as a derivative need, because transportation arises due to the intent or purpose to be achieved through transportation. For example shipping goods, traveling, working and others. The concept of transportation is based on the existence of a journey between origin and destination. Travel is carried out through a certain path

that connects origin and destination, using a conveyance or vehicle at a certain speed.

f) *Intersections*

Intersection is a point on the road network where roads meet and vehicle trajectories intersect. Intersection is the most important factor in determining travel capacity and time on a road network, especially in residential areas. There are several factors that can influence the occurrence of a traffic problem that usually occurs at intersections, including:

- a. Volume and capacity, which directly affects obstacles
- b. Geometric design, and freedom of view
- c. Accidents and road safety, speed and street lights
- d. Parking, access and development are safe
- e. Pedestrian
- f. Distance between intersections

g) *Data Analysis Methods*

To find out the mathematical relationship between these parameters, several data sets can be obtained from the survey results at the observation location using the A and B values. All analyzes are comparative calculations with the Greenshield, Greenberg and Underwood models. From the results of these calculations can be determined the relationship between speed and density of traffic.

### III. RESULTS AND DISCUSSION

a) *Results*

The survey for this study has been conducted for four days, namely on February 19 2018, Monday, Tuesday, Thursday, and Sunday at Simpang IV Bireun, Bireun Regency. The results obtained from the data obtained directly from observations in the field are as follows :

i. *Traffic Volume*

Based on the results of data processing, the traffic volume is obtained by the total volume on every day of junior high school / hour observation, while the full results are displayed in the table below.

Table 3.1: Recapitulation of average traffic volume

No.	hari/Tgl	Average Volume (smp/15 minutes)	Average Volume (smp/hour)
1	Monday	1065,53	4664,37
2	Tuesday	918,32	3699,24
3	Wednesday	699,1	2807,08
4	Thursday	1481,99	6117,62

Sumber : Hasil Pengujian



Based on the results of the study for four days the biggest traffic flow is the direction of the Banda Aceh-Medan road because this road is the main road to the center of Bireun city especially during peak hours. Based on fluctuations graph, the traffic volume from the direction of the Banda Aceh-Medan road that passes through this intersection is quite dense until it reaches 29237.60 (smp / hour), because in the morning it is the first tip of everyone's routine in starting the day.

Based on daily data processing, the peak hour volume is on Tuesday, which is 2292.20 (smp/hour) morning at 12.00-13.00. and afternoon with the number 2128.10 (smp/hour) at 17.00-18.00.

Volume fluctuation The traffic generated from the survey is used to determine peak hours, namely peak morning hours (07.00-08.00), peak afternoon hours (12.00-13.00), and evening peak hours (17.00-18.30).

ii. *Traffic Speed*

From the results of data processing, the average local velocity obtained in the direction of Bireun Medan-Banda Aceh is Monday 29.00 km/h, Tuesday July-Takengon road 28.91 km/h, Thursday Banda Aceh-Medan road 29.93 km/h, the week of Kuala Raja road is 30.57 km/h.

iii. *Traffic Density*

To find out the value of traffic density obtained from data processing volume and speed of traffic, namely from the results of a comparison between the volume value with the speed of traffic at the same time of observation. The value of traffic density is expressed in units smp/km.

b) *Discussion*

Based on the results of data analysis as described above, then by improving the results of data processing and matters relating to the object of this

research, get the discussion as follows. From the results of the graph the relationship between volume and traffic density can be obtained the maximum speed conditions (D) 3297.83 smp/km. This condition is a more real condition closer to the Greenberg model, because only one density condition that occurs and seen from the equations shows that the maximum speed conditions are affected by the density of traffic. From the graph the relationship of speed and density can be explained that if the density increases from zero then the speed of traffic continues to increase, so that more than the density at optimum conditions, a condition will be achieved where the increase in traffic density will not increase the flow of traffic. traffic flow.

The mathematical relationship between speed and traffic density using the Greenshield and underwood model shows the speed of weak traffic density, where it can be explained that if the traffic density continues to increase so that it exceeds the optimum density then the speed of traffic decreases. The results obtained from data processing and analysis show that the relationship that occurs between the speed and density of traffic is looking down. This result is in accordance with what was assumed by the Greenberg method before, namely the mathematical relationship between the speed and density of traffic is to drop down, except that there is a slightly different behavior.

In this study, a comparative analysis of existing traffic characteristics models, namely Greenshield, Greenberg and Underwood, was used, the effectiveness and efficiency of the presentation of the data displayed by each of these methods and from the three methods compared to which the solution was more optimal in vehicle movement. from the relationship between density, speed, and more optimal values found in the Greenberg model.

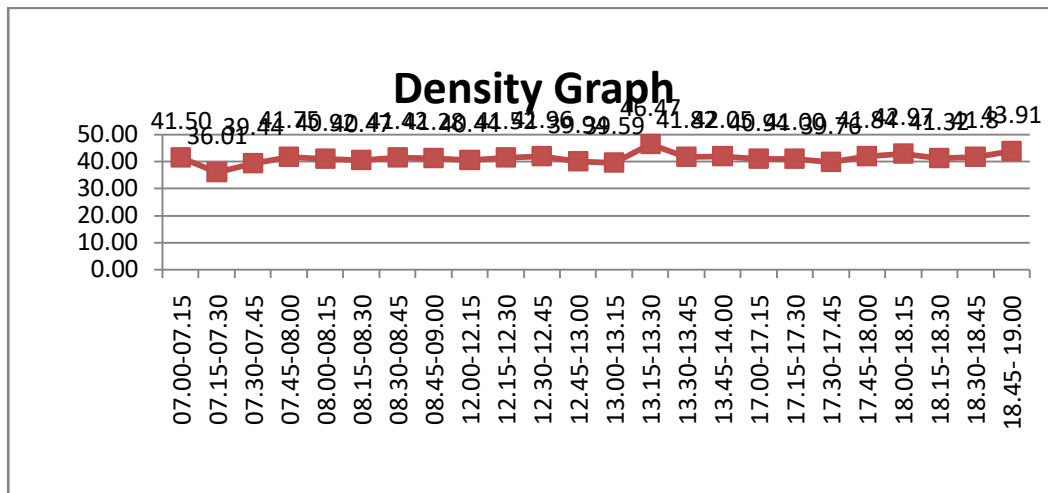

Source: Test Results

S (km/h)

Graph 3.1: Greenshield calculation

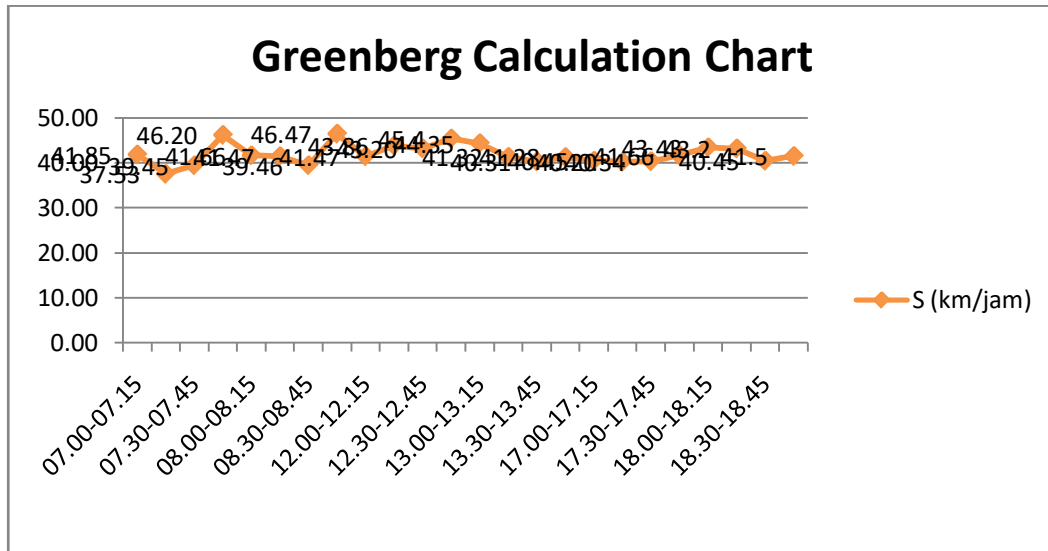

Source: Test Results

Chart 3.2: Calculation of Greenberg

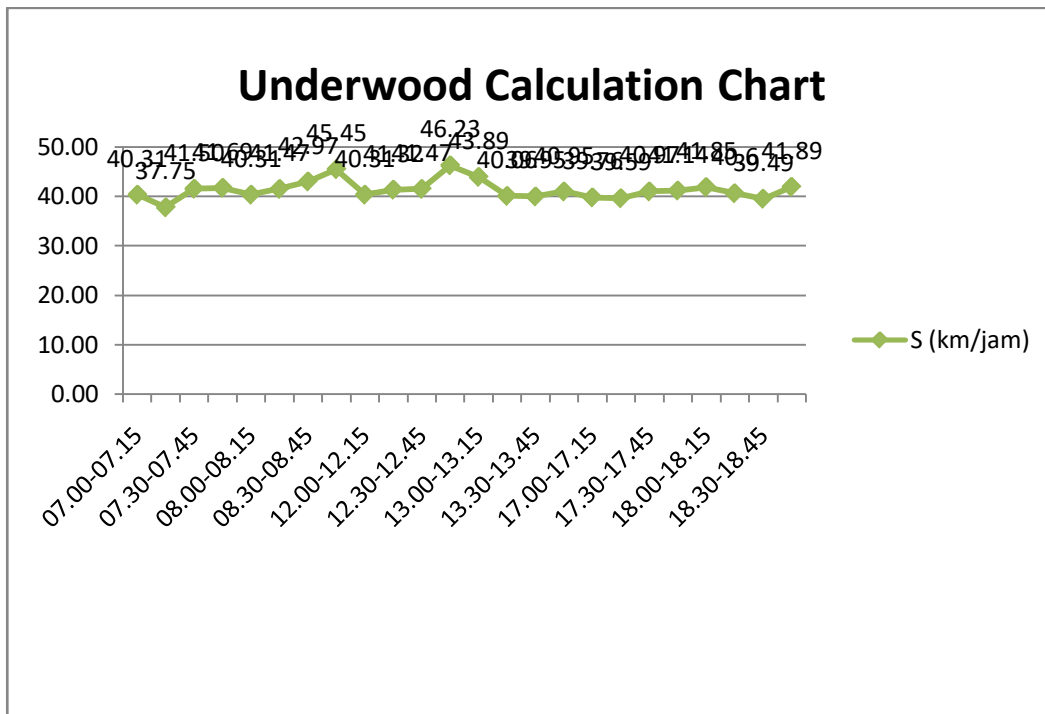

Source: Test Results

Chart 3.3: Calculation of Underwood

The graph of the Greenshield model in this study (Graph 3.1 shows that the optimum density is low. While the underwood graph results show that the density is lower than the Greenshield model graph. For the density velocity, Greenberg has a higher optimum value, while the volume density relationship, both showed results that were almost close to the relationship of volume velocity, so the Greenshield and Underwood approach was still better.

#### IV. CONCLUSIONS AND SUGGESTIONS

##### a) Conclusions

Based on the results of the research and discussion conducted at Simpang 4 Bireun in Bireuen Regency, some conclusions can be taken as follows; the lowest traffic speed and the highest traffic density obtained on Monday, namely DM = 40,6231 smp/km and SM = 0,19 km/hour, the form of mathematical

relationship between speed and density using the Greenshield, Greenberg, Underwood model shows speed with weak traffic density, and the effectiveness of the traffic flow characteristic model is the most optimum model found in the Greenberg model because it has a higher value.

#### b) Suggestions

Further research is needed to get more real values from the three models, namely, Greenshield, Greenberg, and Underwood, comparison of calculations using the Indonesian Capacity Manual (MKJI 1997) Greenshield, Greenberg and Underwood linear modeling needs to be examined again with heavy traffic conditions and high side barriers. The volume of traffic that continues to grow each year becomes the biggest problem for the intersection, especially Simpang 4 Bireuen. To produce a research study from the comparative calculation of the Greenshield, Greenberg and Underwood models in a more accurate relationship of traffic flow characteristics.

### BIBLIOGRAPHY

1. Ahmad Munawar, 2005. "Dasar-dasar Teknik Transportasi", Beta Offset, Yogyakarta.
2. Anonim, 1970. Penataan Arus Lalu Lintas di Kawasan Mesjid Raya *Baiturrahman Banda Aceh*. Banda Aceh: Satker Pengembangan LLAJ Dishub Provinsi NAD.
3. Asian Development Bank, 2003." *Panduan Keselamatan Jalan untuk Kawasan Asia Pasifik*", Asian Development Bank, Manila.
4. Direktorat Jenderal Bina Marga, 1997. *Manual Kapasitas Jalan Indonesia (MKJI 1997)*.
5. Hendra Wibisana, 2007. "Studi Hubungan Arus Lalu Lintas Di Ruas Jalan Rungkut Asri Kotamadya Surabaya Dengan Metode Underwood", Jurnal Teknik Sipil, Vol 3, No.2 Oktober 2007, Maranatha, Bandung.
6. Khisty C. J., Kent Lall., 2003. "Transportation Engineering An Introduction", Third Edition, Prentice Hall, New Jersey.
7. Morlok, E.K, 1988. *Pengantar Teknik dan perencanaan Transportasi*. Terjemahan J.K Haini, Erlangga, Jakarta.
8. Mcshare dan Roes, 1970. *Model Persamaan Greenshield, Greenberg, dan Underwood*. Universitas Gajah Mada Press, Yogyakarta.
9. Nasution, 2004. *Rekayasa Lalu Lintas I.: Bidang Studi Teknik Transportasi Jurusan Teknik Sipil Syiah Kuala, Banda Aceh*.
10. Prof.Ir. Leksmono Suryo Putranto, M.T., Ph.D, *Rekayasa Lalu Lintas*, Direktorat Jenderal Perhubungan Darat, Jakarta.
11. Ririn Gamran, Freddy Jansen, M.J.Paransa. *Perbandingan Metode Greenshield, Greenberg, Underwood (MKJI 1997)*, Ratulangi.
12. Sudjana, 1992. *Metode Stastistik*, Transito, Bandung.
13. Tamin, O. Z, 1991. "Perencanaan dan pemodelan Transportasi", ITB Bandung.
14. Tamin O. Z, 2000. *Hubungan Matematis Kecepatan Kepadatan Lalu Lintas*, Universitas Gajah Mada Press, Yogyakarta. 7

# GLOBAL JOURNALS GUIDELINES HANDBOOK 2019

---

[WWW.GLOBALJOURNALS.ORG](http://WWW.GLOBALJOURNALS.ORG)

# FELLOWS

## FELLOW OF ASSOCIATION OF RESEARCH SOCIETY IN ENGINEERING (FARSE)

Global Journals Incorporate (USA) is accredited by Open Association of Research Society (OARS), U.S.A and in turn, awards “FARSE ” title to individuals. The 'FARSE' title is accorded to a selected professional after the approval of the Editor-in-Chief /Editorial Board Members/Dean.



- The “FARSE” is a dignified title which is accorded to a person’s name viz. Dr. John E. Hall, Ph.D., FARSE or William Walldroff, M.S., FARSE.

FARSE accrediting is an honor. It authenticates your research activities. After recognition as FARSE, you can add 'FARSE' title with your name as you use this recognition as additional suffix to your status. This will definitely enhance and add more value and repute to your name. You may use it on your professional Counseling Materials such as CV, Resume, and Visiting Card etc.

*The following benefits can be availed by you only for next three years from the date of certification:*



FARSE designated members are entitled to avail a 40% discount while publishing their research papers (of a single author) with Global Journals Incorporation (USA), if the same is accepted by Editorial Board/Peer Reviewers. If you are a main author or co-author in case of multiple authors, you will be entitled to avail discount of 10%.

Once FARSE title is accorded, the Fellow is authorized to organize a symposium/seminar/conference on behalf of Global Journal Incorporation (USA).The Fellow can also participate in conference/seminar/symposium organized by another institution as representative of Global Journal. In both the cases, it is mandatory for him to discuss with us and obtain our consent.



You may join as member of the Editorial Board of Global Journals Incorporation (USA) after successful completion of three years as Fellow and as Peer Reviewer. In addition, it is also desirable that you should organize seminar/symposium/conference at least once.

We shall provide you intimation regarding launching of e-version of journal of your stream time to time.This may be utilized in your library for the enrichment of knowledge of your students as well as it can also be helpful for the concerned faculty members.







The FARSE can go through standards of OARS. You can also play vital role if you have any suggestions so that proper amendment can take place to improve the same for the benefit of entire research community.

As FARSE, you will be given a renowned, secure and free professional email address with 100 GB of space e.g. johnhall@globaljournals.org. This will include Webmail, Spam Assassin, Email Forwarders, Auto-Responders, Email Delivery Route tracing, etc.

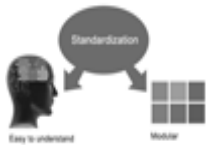

The FARSE will be eligible for a free application of standardization of their researches. Standardization of research will be subject to acceptability within stipulated norms as the next step after publishing in a journal. We shall depute a team of specialized research professionals who will render their services for elevating your researches to next higher level, which is worldwide open standardization.

The FARSE member can apply for grading and certification of standards of their educational and Institutional Degrees to Open Association of Research, Society U.S.A. Once you are designated as FARSE, you may send us a scanned copy of all of your credentials. OARS will verify, grade and certify them. This will be based on your academic records, quality of research papers published by you, and some more criteria. After certification of all your credentials by OARS, they will be published on your Fellow Profile link on website <https://associationofresearch.org> which will be helpful to upgrade the dignity.



The FARSE members can avail the benefits of free research podcasting in Global Research Radio with their research documents. After publishing the work, (including published elsewhere worldwide with proper authorization) you can upload your research paper with your recorded voice or you can utilize chargeable services of our professional RJs to record your paper in their voice on request.

The FARSE member also entitled to get the benefits of free research podcasting of their research documents through video clips. We can also streamline your conference videos and display your slides/ online slides and online research video clips at reasonable charges, on request.





The FARSE is eligible to earn from sales proceeds of his/her researches/reference/review Books or literature, while publishing with Global Journals. The FARSE can decide whether he/she would like to publish his/her research in a closed manner. In this case, whenever readers purchase that individual research paper for reading, maximum 60% of its profit earned as royalty by Global Journals, will

be credited to his/her bank account. The entire entitled amount will be credited to his/her bank account exceeding limit of minimum fixed balance. There is no minimum time limit for collection. The FARSE member can decide its price and we can help in making the right decision.

The FARSE member is eligible to join as a paid peer reviewer at Global Journals Incorporation (USA) and can get remuneration of 15% of author fees, taken from the author of a respective paper. After reviewing 5 or more papers you can request to transfer the amount to your bank account.



## MEMBER OF ASSOCIATION OF RESEARCH SOCIETY IN ENGINEERING (MARSE)

The 'MARSE ' title is accorded to a selected professional after the approval of the Editor-in-Chief / Editorial Board Members/Dean.

The “MARSE” is a dignified ornament which is accorded to a person’s name viz. Dr. John E. Hall, Ph.D., MARSE or William Walldroff, M.S., MARSE.



MARSE accrediting is an honor. It authenticates your research activities. After becoming MARSE, you can add 'MARSE' title with your name as you use this recognition as additional suffix to your status. This will definitely enhance and add more value and repute to your name. You may use it on your professional Counseling Materials such as CV, Resume, Visiting Card and Name Plate etc.

*The following benefits can be availed by you only for next three years from the date of certification.*



MARSE designated members are entitled to avail a 25% discount while publishing their research papers (of a single author) in Global Journals Inc., if the same is accepted by our Editorial Board and Peer Reviewers. If you are a main author or co-author of a group of authors, you will get discount of 10%.

As MARSE, you will be given a renowned, secure and free professional email address with 30 GB of space e.g. johnhall@globaljournals.org. This will include Webmail, Spam Assassin, Email Forwarders, Auto-Responders, Email Delivery Route tracing, etc.





We shall provide you intimation regarding launching of e-version of journal of your stream time to time. This may be utilized in your library for the enrichment of knowledge of your students as well as it can also be helpful for the concerned faculty members.

The MARSE member can apply for approval, grading and certification of standards of their educational and Institutional Degrees to Open Association of Research, Society U.S.A.



Once you are designated as MARSE, you may send us a scanned copy of all of your credentials. OARS will verify, grade and certify them. This will be based on your academic records, quality of research papers published by you, and some more criteria.

It is mandatory to read all terms and conditions carefully.



# AUXILIARY MEMBERSHIPS

## Institutional Fellow of Open Association of Research Society (USA)-OARS (USA)

Global Journals Incorporation (USA) is accredited by Open Association of Research Society, U.S.A (OARS) and in turn, affiliates research institutions as “Institutional Fellow of Open Association of Research Society” (IFOARS).



The “FARSC” is a dignified title which is accorded to a person’s name viz. Dr. John E. Hall, Ph.D., FARSC or William Walldroff, M.S., FARSC.

The IFOARS institution is entitled to form a Board comprised of one Chairperson and three to five board members preferably from different streams. The Board will be recognized as “Institutional Board of Open Association of Research Society”-(IBOARS).

*The Institute will be entitled to following benefits:*



The IBOARS can initially review research papers of their institute and recommend them to publish with respective journal of Global Journals. It can also review the papers of other institutions after obtaining our consent. The second review will be done by peer reviewer of Global Journals Incorporation (USA) The Board is at liberty to appoint a peer reviewer with the approval of chairperson after consulting us.

The author fees of such paper may be waived off up to 40%.

The Global Journals Incorporation (USA) at its discretion can also refer double blind peer reviewed paper at their end to the board for the verification and to get recommendation for final stage of acceptance of publication.



The IBOARS can organize symposium/seminar/conference in their country on behalf of Global Journals Incorporation (USA)-OARS (USA). The terms and conditions can be discussed separately.

The Board can also play vital role by exploring and giving valuable suggestions regarding the Standards of “Open Association of Research Society, U.S.A (OARS)” so that proper amendment can take place for the benefit of entire research community. We shall provide details of particular standard only on receipt of request from the Board.



The board members can also join us as Individual Fellow with 40% discount on total fees applicable to Individual Fellow. They will be entitled to avail all the benefits as declared. Please visit Individual Fellow-sub menu of GlobalJournals.org to have more relevant details.



We shall provide you intimation regarding launching of e-version of journal of your stream time to time. This may be utilized in your library for the enrichment of knowledge of your students as well as it can also be helpful for the concerned faculty members.



After nomination of your institution as “Institutional Fellow” and constantly functioning successfully for one year, we can consider giving recognition to your institute to function as Regional/Zonal office on our behalf. The board can also take up the additional allied activities for betterment after our consultation.

**The following entitlements are applicable to individual Fellows:**

Open Association of Research Society, U.S.A (OARS) By-laws states that an individual Fellow may use the designations as applicable, or the corresponding initials. The Credentials of individual Fellow and Associate designations signify that the individual has gained knowledge of the fundamental concepts. One is magnanimous and proficient in an expertise course covering the professional code of conduct, and follows recognized standards of practice.



Open Association of Research Society (US)/ Global Journals Incorporation (USA), as described in Corporate Statements, are educational, research publishing and professional membership organizations. Achieving our individual Fellow or Associate status is based mainly on meeting stated educational research requirements.

Disbursement of 40% Royalty earned through Global Journals : Researcher = 50%, Peer Reviewer = 37.50%, Institution = 12.50% E.g. Out of 40%, the 20% benefit should be passed on to researcher, 15 % benefit towards remuneration should be given to a reviewer and remaining 5% is to be retained by the institution.



We shall provide print version of 12 issues of any three journals [as per your requirement] out of our 38 journals worth \$ 2376 USD.

**Other:**

**The individual Fellow and Associate designations accredited by Open Association of Research Society (US) credentials signify guarantees following achievements:**

- The professional accredited with Fellow honor, is entitled to various benefits viz. name, fame, honor, regular flow of income, secured bright future, social status etc.



- In addition to above, if one is single author, then entitled to 40% discount on publishing research paper and can get 10% discount if one is co-author or main author among group of authors.
- The Fellow can organize symposium/seminar/conference on behalf of Global Journals Incorporation (USA) and he/she can also attend the same organized by other institutes on behalf of Global Journals.
- The Fellow can become member of Editorial Board Member after completing 3yrs.
- The Fellow can earn 60% of sales proceeds from the sale of reference/review books/literature/publishing of research paper.
- Fellow can also join as paid peer reviewer and earn 15% remuneration of author charges and can also get an opportunity to join as member of the Editorial Board of Global Journals Incorporation (USA)
- • This individual has learned the basic methods of applying those concepts and techniques to common challenging situations. This individual has further demonstrated an in-depth understanding of the application of suitable techniques to a particular area of research practice.

**Note :**

//

- In future, if the board feels the necessity to change any board member, the same can be done with the consent of the chairperson along with anyone board member without our approval.
- In case, the chairperson needs to be replaced then consent of 2/3rd board members are required and they are also required to jointly pass the resolution copy of which should be sent to us. In such case, it will be compulsory to obtain our approval before replacement.
- In case of “Difference of Opinion [if any]” among the Board members, our decision will be final and binding to everyone.

//





## PREFERRED AUTHOR GUIDELINES

---

### **We accept the manuscript submissions in any standard (generic) format.**

We typeset manuscripts using advanced typesetting tools like Adobe In Design, CorelDraw, TeXnicCenter, and TeXStudio. We usually recommend authors submit their research using any standard format they are comfortable with, and let Global Journals do the rest.

Alternatively, you can download our basic template from <https://globaljournals.org/Template.zip>

Authors should submit their complete paper/article, including text illustrations, graphics, conclusions, artwork, and tables. Authors who are not able to submit manuscript using the form above can email the manuscript department at [submit@globaljournals.org](mailto:submit@globaljournals.org) or get in touch with [chiefeditor@globaljournals.org](mailto:chiefeditor@globaljournals.org) if they wish to send the abstract before submission.

### BEFORE AND DURING SUBMISSION

Authors must ensure the information provided during the submission of a paper is authentic. Please go through the following checklist before submitting:

1. Authors must go through the complete author guideline and understand and *agree to Global Journals' ethics and code of conduct*, along with author responsibilities.
2. Authors must accept the privacy policy, terms, and conditions of Global Journals.
3. Ensure corresponding author's email address and postal address are accurate and reachable.
4. Manuscript to be submitted must include keywords, an abstract, a paper title, co-author(s) names and details (email address, name, phone number, and institution), figures and illustrations in vector format including appropriate captions, tables, including titles and footnotes, a conclusion, results, acknowledgments and references.
5. Authors should submit paper in a ZIP archive if any supplementary files are required along with the paper.
6. Proper permissions must be acquired for the use of any copyrighted material.
7. Manuscript submitted *must not have been submitted or published elsewhere* and all authors must be aware of the submission.

### **Declaration of Conflicts of Interest**

It is required for authors to declare all financial, institutional, and personal relationships with other individuals and organizations that could influence (bias) their research.

### POLICY ON PLAGIARISM

Plagiarism is not acceptable in Global Journals submissions at all.

Plagiarized content will not be considered for publication. We reserve the right to inform authors' institutions about plagiarism detected either before or after publication. If plagiarism is identified, we will follow COPE guidelines:

Authors are solely responsible for all the plagiarism that is found. The author must not fabricate, falsify or plagiarize existing research data. The following, if copied, will be considered plagiarism:

- Words (language)
- Ideas
- Findings
- Writings
- Diagrams
- Graphs
- Illustrations
- Lectures



- Printed material
- Graphic representations
- Computer programs
- Electronic material
- Any other original work

## AUTHORSHIP POLICIES

Global Journals follows the definition of authorship set up by the Open Association of Research Society, USA. According to its guidelines, authorship criteria must be based on:

1. Substantial contributions to the conception and acquisition of data, analysis, and interpretation of findings.
2. Drafting the paper and revising it critically regarding important academic content.
3. Final approval of the version of the paper to be published.

### Changes in Authorship

The corresponding author should mention the name and complete details of all co-authors during submission and in manuscript. We support addition, rearrangement, manipulation, and deletions in authors list till the early view publication of the journal. We expect that corresponding author will notify all co-authors of submission. We follow COPE guidelines for changes in authorship.

### Copyright

During submission of the manuscript, the author is confirming an exclusive license agreement with Global Journals which gives Global Journals the authority to reproduce, reuse, and republish authors' research. We also believe in flexible copyright terms where copyright may remain with authors/employers/institutions as well. Contact your editor after acceptance to choose your copyright policy. You may follow this form for copyright transfers.

### Appealing Decisions

Unless specified in the notification, the Editorial Board's decision on publication of the paper is final and cannot be appealed before making the major change in the manuscript.

### Acknowledgments

Contributors to the research other than authors credited should be mentioned in Acknowledgments. The source of funding for the research can be included. Suppliers of resources may be mentioned along with their addresses.

### Declaration of funding sources

Global Journals is in partnership with various universities, laboratories, and other institutions worldwide in the research domain. Authors are requested to disclose their source of funding during every stage of their research, such as making analysis, performing laboratory operations, computing data, and using institutional resources, from writing an article to its submission. This will also help authors to get reimbursements by requesting an open access publication letter from Global Journals and submitting to the respective funding source.

## PREPARING YOUR MANUSCRIPT

Authors can submit papers and articles in an acceptable file format: MS Word (doc, docx), LaTeX (.tex, .zip or .rar including all of your files), Adobe PDF (.pdf), rich text format (.rtf), simple text document (.txt), Open Document Text (.odt), and Apple Pages (.pages). Our professional layout editors will format the entire paper according to our official guidelines. This is one of the highlights of publishing with Global Journals—authors should not be concerned about the formatting of their paper. Global Journals accepts articles and manuscripts in every major language, be it Spanish, Chinese, Japanese, Portuguese, Russian, French, German, Dutch, Italian, Greek, or any other national language, but the title, subtitle, and abstract should be in English. This will facilitate indexing and the pre-peer review process.

The following is the official style and template developed for publication of a research paper. Authors are not required to follow this style during the submission of the paper. It is just for reference purposes.



### ***Manuscript Style Instruction (Optional)***

- Microsoft Word Document Setting Instructions.
- Font type of all text should be Swis721 Lt BT.
- Page size: 8.27" x 11", left margin: 0.65, right margin: 0.65, bottom margin: 0.75.
- Paper title should be in one column of font size 24.
- Author name in font size of 11 in one column.
- Abstract: font size 9 with the word "Abstract" in bold italics.
- Main text: font size 10 with two justified columns.
- Two columns with equal column width of 3.38 and spacing of 0.2.
- First character must be three lines drop-capped.
- The paragraph before spacing of 1 pt and after of 0 pt.
- Line spacing of 1 pt.
- Large images must be in one column.
- The names of first main headings (Heading 1) must be in Roman font, capital letters, and font size of 10.
- The names of second main headings (Heading 2) must not include numbers and must be in italics with a font size of 10.

### ***Structure and Format of Manuscript***

The recommended size of an original research paper is under 15,000 words and review papers under 7,000 words. Research articles should be less than 10,000 words. Research papers are usually longer than review papers. Review papers are reports of significant research (typically less than 7,000 words, including tables, figures, and references)

A research paper must include:

- a) A title which should be relevant to the theme of the paper.
- b) A summary, known as an abstract (less than 150 words), containing the major results and conclusions.
- c) Up to 10 keywords that precisely identify the paper's subject, purpose, and focus.
- d) An introduction, giving fundamental background objectives.
- e) Resources and techniques with sufficient complete experimental details (wherever possible by reference) to permit repetition, sources of information must be given, and numerical methods must be specified by reference.
- f) Results which should be presented concisely by well-designed tables and figures.
- g) Suitable statistical data should also be given.
- h) All data must have been gathered with attention to numerical detail in the planning stage.

Design has been recognized to be essential to experiments for a considerable time, and the editor has decided that any paper that appears not to have adequate numerical treatments of the data will be returned unrefereed.

- i) Discussion should cover implications and consequences and not just recapitulate the results; conclusions should also be summarized.
- j) There should be brief acknowledgments.
- k) There ought to be references in the conventional format. Global Journals recommends APA format.

Authors should carefully consider the preparation of papers to ensure that they communicate effectively. Papers are much more likely to be accepted if they are carefully designed and laid out, contain few or no errors, are summarizing, and follow instructions. They will also be published with much fewer delays than those that require much technical and editorial correction.

The Editorial Board reserves the right to make literary corrections and suggestions to improve brevity.

## FORMAT STRUCTURE

***It is necessary that authors take care in submitting a manuscript that is written in simple language and adheres to published guidelines.***

All manuscripts submitted to Global Journals should include:

### **Title**

The title page must carry an informative title that reflects the content, a running title (less than 45 characters together with spaces), names of the authors and co-authors, and the place(s) where the work was carried out.

### **Author details**

The full postal address of any related author(s) must be specified.

### **Abstract**

The abstract is the foundation of the research paper. It should be clear and concise and must contain the objective of the paper and inferences drawn. It is advised to not include big mathematical equations or complicated jargon.

Many researchers searching for information online will use search engines such as Google, Yahoo or others. By optimizing your paper for search engines, you will amplify the chance of someone finding it. In turn, this will make it more likely to be viewed and cited in further works. Global Journals has compiled these guidelines to facilitate you to maximize the web-friendliness of the most public part of your paper.

### **Keywords**

A major lynchpin of research work for the writing of research papers is the keyword search, which one will employ to find both library and internet resources. Up to eleven keywords or very brief phrases have to be given to help data retrieval, mining, and indexing.

One must be persistent and creative in using keywords. An effective keyword search requires a strategy: planning of a list of possible keywords and phrases to try.

Choice of the main keywords is the first tool of writing a research paper. Research paper writing is an art. Keyword search should be as strategic as possible.

One should start brainstorming lists of potential keywords before even beginning searching. Think about the most important concepts related to research work. Ask, "What words would a source have to include to be truly valuable in a research paper?" Then consider synonyms for the important words.

It may take the discovery of only one important paper to steer in the right keyword direction because, in most databases, the keywords under which a research paper is abstracted are listed with the paper.

### **Numerical Methods**

Numerical methods used should be transparent and, where appropriate, supported by references.

### **Abbreviations**

Authors must list all the abbreviations used in the paper at the end of the paper or in a separate table before using them.

### **Formulas and equations**

Authors are advised to submit any mathematical equation using either MathJax, KaTeX, or LaTeX, or in a very high-quality image.

### **Tables, Figures, and Figure Legends**

Tables: Tables should be cautiously designed, uncrowned, and include only essential data. Each must have an Arabic number, e.g., Table 4, a self-explanatory caption, and be on a separate sheet. Authors must submit tables in an editable format and not as images. References to these tables (if any) must be mentioned accurately.



## Figures

Figures are supposed to be submitted as separate files. Always include a citation in the text for each figure using Arabic numbers, e.g., Fig. 4. Artwork must be submitted online in vector electronic form or by emailing it.

## PREPARATION OF ELETRONIC FIGURES FOR PUBLICATION

Although low-quality images are sufficient for review purposes, print publication requires high-quality images to prevent the final product being blurred or fuzzy. Submit (possibly by e-mail) EPS (line art) or TIFF (halftone/ photographs) files only. MS PowerPoint and Word Graphics are unsuitable for printed pictures. Avoid using pixel-oriented software. Scans (TIFF only) should have a resolution of at least 350 dpi (halftone) or 700 to 1100 dpi (line drawings). Please give the data for figures in black and white or submit a Color Work Agreement form. EPS files must be saved with fonts embedded (and with a TIFF preview, if possible).

For scanned images, the scanning resolution at final image size ought to be as follows to ensure good reproduction: line art: >650 dpi; halftones (including gel photographs): >350 dpi; figures containing both halftone and line images: >650 dpi.

Color charges: Authors are advised to pay the full cost for the reproduction of their color artwork. Hence, please note that if there is color artwork in your manuscript when it is accepted for publication, we would require you to complete and return a Color Work Agreement form before your paper can be published. Also, you can email your editor to remove the color fee after acceptance of the paper.

## TIPS FOR WRITING A GOOD QUALITY ENGINEERING RESEARCH PAPER

Techniques for writing a good quality engineering research paper:

**1. Choosing the topic:** In most cases, the topic is selected by the interests of the author, but it can also be suggested by the guides. You can have several topics, and then judge which you are most comfortable with. This may be done by asking several questions of yourself, like "Will I be able to carry out a search in this area? Will I find all necessary resources to accomplish the search? Will I be able to find all information in this field area?" If the answer to this type of question is "yes," then you ought to choose that topic. In most cases, you may have to conduct surveys and visit several places. Also, you might have to do a lot of work to find all the rises and falls of the various data on that subject. Sometimes, detailed information plays a vital role, instead of short information. Evaluators are human: The first thing to remember is that evaluators are also human beings. They are not only meant for rejecting a paper. They are here to evaluate your paper. So present your best aspect.

**2. Think like evaluators:** If you are in confusion or getting demotivated because your paper may not be accepted by the evaluators, then think, and try to evaluate your paper like an evaluator. Try to understand what an evaluator wants in your research paper, and you will automatically have your answer. Make blueprints of paper: The outline is the plan or framework that will help you to arrange your thoughts. It will make your paper logical. But remember that all points of your outline must be related to the topic you have chosen.

**3. Ask your guides:** If you are having any difficulty with your research, then do not hesitate to share your difficulty with your guide (if you have one). They will surely help you out and resolve your doubts. If you can't clarify what exactly you require for your work, then ask your supervisor to help you with an alternative. He or she might also provide you with a list of essential readings.

**4. Use of computer is recommended:** As you are doing research in the field of research engineering then this point is quite obvious. Use right software: Always use good quality software packages. If you are not capable of judging good software, then you can lose the quality of your paper unknowingly. There are various programs available to help you which you can get through the internet.

**5. Use the internet for help:** An excellent start for your paper is using Google. It is a wondrous search engine, where you can have your doubts resolved. You may also read some answers for the frequent question of how to write your research paper or find a model research paper. You can download books from the internet. If you have all the required books, place importance on reading, selecting, and analyzing the specified information. Then sketch out your research paper. Use big pictures: You may use encyclopedias like Wikipedia to get pictures with the best resolution. At Global Journals, you should strictly follow [here](#).



**6. Bookmarks are useful:** When you read any book or magazine, you generally use bookmarks, right? It is a good habit which helps to not lose your continuity. You should always use bookmarks while searching on the internet also, which will make your search easier.

**7. Revise what you wrote:** When you write anything, always read it, summarize it, and then finalize it.

**8. Make every effort:** Make every effort to mention what you are going to write in your paper. That means always have a good start. Try to mention everything in the introduction—what is the need for a particular research paper. Polish your work with good writing skills and always give an evaluator what he wants. Make backups: When you are going to do any important thing like making a research paper, you should always have backup copies of it either on your computer or on paper. This protects you from losing any portion of your important data.

**9. Produce good diagrams of your own:** Always try to include good charts or diagrams in your paper to improve quality. Using several unnecessary diagrams will degrade the quality of your paper by creating a hodgepodge. So always try to include diagrams which were made by you to improve the readability of your paper. Use of direct quotes: When you do research relevant to literature, history, or current affairs, then use of quotes becomes essential, but if the study is relevant to science, use of quotes is not preferable.

**10. Use proper verb tense:** Use proper verb tenses in your paper. Use past tense to present those events that have happened. Use present tense to indicate events that are going on. Use future tense to indicate events that will happen in the future. Use of wrong tenses will confuse the evaluator. Avoid sentences that are incomplete.

**11. Pick a good study spot:** Always try to pick a spot for your research which is quiet. Not every spot is good for studying.

**12. Know what you know:** Always try to know what you know by making objectives, otherwise you will be confused and unable to achieve your target.

**13. Use good grammar:** Always use good grammar and words that will have a positive impact on the evaluator; use of good vocabulary does not mean using tough words which the evaluator has to find in a dictionary. Do not fragment sentences. Eliminate one-word sentences. Do not ever use a big word when a smaller one would suffice.

Verbs have to be in agreement with their subjects. In a research paper, do not start sentences with conjunctions or finish them with prepositions. When writing formally, it is advisable to never split an infinitive because someone will (wrongly) complain. Avoid clichés like a disease. Always shun irritating alliteration. Use language which is simple and straightforward. Put together a neat summary.

**14. Arrangement of information:** Each section of the main body should start with an opening sentence, and there should be a changeover at the end of the section. Give only valid and powerful arguments for your topic. You may also maintain your arguments with records.

**15. Never start at the last minute:** Always allow enough time for research work. Leaving everything to the last minute will degrade your paper and spoil your work.

**16. Multitasking in research is not good:** Doing several things at the same time is a bad habit in the case of research activity. Research is an area where everything has a particular time slot. Divide your research work into parts, and do a particular part in a particular time slot.

**17. Never copy others' work:** Never copy others' work and give it your name because if the evaluator has seen it anywhere, you will be in trouble. Take proper rest and food: No matter how many hours you spend on your research activity, if you are not taking care of your health, then all your efforts will have been in vain. For quality research, take proper rest and food.

**18. Go to seminars:** Attend seminars if the topic is relevant to your research area. Utilize all your resources.

**19. Refresh your mind after intervals:** Try to give your mind a rest by listening to soft music or sleeping in intervals. This will also improve your memory. Acquire colleagues: Always try to acquire colleagues. No matter how sharp you are, if you acquire colleagues, they can give you ideas which will be helpful to your research.

**20. Think technically:** Always think technically. If anything happens, search for its reasons, benefits, and demerits. Think and then print: When you go to print your paper, check that tables are not split, headings are not detached from their descriptions, and page sequence is maintained.





**21. Adding unnecessary information:** Do not add unnecessary information like "I have used MS Excel to draw graphs." Irrelevant and inappropriate material is superfluous. Foreign terminology and phrases are not apropos. One should never take a broad view. Analogy is like feathers on a snake. Use words properly, regardless of how others use them. Remove quotations. Puns are for kids, not grunt readers. Never oversimplify: When adding material to your research paper, never go for oversimplification; this will definitely irritate the evaluator. Be specific. Never use rhythmic redundancies. Contractions shouldn't be used in a research paper. Comparisons are as terrible as clichés. Give up ampersands, abbreviations, and so on. Remove commas that are not necessary. Parenthetical words should be between brackets or commas. Understatement is always the best way to put forward earth-shaking thoughts. Give a detailed literary review.

**22. Report concluded results:** Use concluded results. From raw data, filter the results, and then conclude your studies based on measurements and observations taken. An appropriate number of decimal places should be used. Parenthetical remarks are prohibited here. Proofread carefully at the final stage. At the end, give an outline to your arguments. Spot perspectives of further study of the subject. Justify your conclusion at the bottom sufficiently, which will probably include examples.

**23. Upon conclusion:** Once you have concluded your research, the next most important step is to present your findings. Presentation is extremely important as it is the definite medium through which your research is going to be in print for the rest of the crowd. Care should be taken to categorize your thoughts well and present them in a logical and neat manner. A good quality research paper format is essential because it serves to highlight your research paper and bring to light all necessary aspects of your research.

## INFORMAL GUIDELINES OF RESEARCH PAPER WRITING

### **Key points to remember:**

- Submit all work in its final form.
- Write your paper in the form which is presented in the guidelines using the template.
- Please note the criteria peer reviewers will use for grading the final paper.

### **Final points:**

One purpose of organizing a research paper is to let people interpret your efforts selectively. The journal requires the following sections, submitted in the order listed, with each section starting on a new page:

*The introduction:* This will be compiled from reference matter and reflect the design processes or outline of basis that directed you to make a study. As you carry out the process of study, the method and process section will be constructed like that. The results segment will show related statistics in nearly sequential order and direct reviewers to similar intellectual paths throughout the data that you gathered to carry out your study.

### **The discussion section:**

This will provide understanding of the data and projections as to the implications of the results. The use of good quality references throughout the paper will give the effort trustworthiness by representing an alertness to prior workings.

Writing a research paper is not an easy job, no matter how trouble-free the actual research or concept. Practice, excellent preparation, and controlled record-keeping are the only means to make straightforward progression.

### **General style:**

Specific editorial column necessities for compliance of a manuscript will always take over from directions in these general guidelines.

**To make a paper clear:** Adhere to recommended page limits.

### *Mistakes to avoid:*

- Insertion of a title at the foot of a page with subsequent text on the next page.
- Separating a table, chart, or figure—confine each to a single page.
- Submitting a manuscript with pages out of sequence.
- In every section of your document, use standard writing style, including articles ("a" and "the").
- Keep paying attention to the topic of the paper.



- Use paragraphs to split each significant point (excluding the abstract).
- Align the primary line of each section.
- Present your points in sound order.
- Use present tense to report well-accepted matters.
- Use past tense to describe specific results.
- Do not use familiar wording; don't address the reviewer directly. Don't use slang or superlatives.
- Avoid use of extra pictures—include only those figures essential to presenting results.

#### **Title page:**

Choose a revealing title. It should be short and include the name(s) and address(es) of all authors. It should not have acronyms or abbreviations or exceed two printed lines.

**Abstract:** This summary should be two hundred words or less. It should clearly and briefly explain the key findings reported in the manuscript and must have precise statistics. It should not have acronyms or abbreviations. It should be logical in itself. Do not cite references at this point.

An abstract is a brief, distinct paragraph summary of finished work or work in development. In a minute or less, a reviewer can be taught the foundation behind the study, common approaches to the problem, relevant results, and significant conclusions or new questions.

Write your summary when your paper is completed because how can you write the summary of anything which is not yet written? Wealth of terminology is very essential in abstract. Use comprehensive sentences, and do not sacrifice readability for brevity; you can maintain it succinctly by phrasing sentences so that they provide more than a lone rationale. The author can at this moment go straight to shortening the outcome. Sum up the study with the subsequent elements in any summary. Try to limit the initial two items to no more than one line each.

*Reason for writing the article—theory, overall issue, purpose.*

- Fundamental goal.
- To-the-point depiction of the research.
- Consequences, including definite statistics—if the consequences are quantitative in nature, account for this; results of any numerical analysis should be reported. Significant conclusions or questions that emerge from the research.

#### **Approach:**

- Single section and succinct.
- An outline of the job done is always written in past tense.
- Concentrate on shortening results—limit background information to a verdict or two.
- Exact spelling, clarity of sentences and phrases, and appropriate reporting of quantities (proper units, important statistics) are just as significant in an abstract as they are anywhere else.

#### **Introduction:**

The introduction should "introduce" the manuscript. The reviewer should be presented with sufficient background information to be capable of comprehending and calculating the purpose of your study without having to refer to other works. The basis for the study should be offered. Give the most important references, but avoid making a comprehensive appraisal of the topic. Describe the problem visibly. If the problem is not acknowledged in a logical, reasonable way, the reviewer will give no attention to your results. Speak in common terms about techniques used to explain the problem, if needed, but do not present any particulars about the protocols here.

*The following approach can create a valuable beginning:*

- Explain the value (significance) of the study.
- Defend the model—why did you employ this particular system or method? What is its compensation? Remark upon its appropriateness from an abstract point of view as well as pointing out sensible reasons for using it.
- Present a justification. State your particular theory(-ies) or aim(s), and describe the logic that led you to choose them.
- Briefly explain the study's tentative purpose and how it meets the declared objectives.



**Approach:**

Use past tense except for when referring to recognized facts. After all, the manuscript will be submitted after the entire job is done. Sort out your thoughts; manufacture one key point for every section. If you make the four points listed above, you will need at least four paragraphs. Present surrounding information only when it is necessary to support a situation. The reviewer does not desire to read everything you know about a topic. Shape the theory specifically—do not take a broad view.

As always, give awareness to spelling, simplicity, and correctness of sentences and phrases.

**Procedures (methods and materials):**

This part is supposed to be the easiest to carve if you have good skills. A soundly written procedures segment allows a capable scientist to replicate your results. Present precise information about your supplies. The suppliers and clarity of reagents can be helpful bits of information. Present methods in sequential order, but linked methodologies can be grouped as a segment. Be concise when relating the protocols. Attempt to give the least amount of information that would permit another capable scientist to replicate your outcome, but be cautious that vital information is integrated. The use of subheadings is suggested and ought to be synchronized with the results section.

When a technique is used that has been well-described in another section, mention the specific item describing the way, but draw the basic principle while stating the situation. The purpose is to show all particular resources and broad procedures so that another person may use some or all of the methods in one more study or referee the scientific value of your work. It is not to be a step-by-step report of the whole thing you did, nor is a methods section a set of orders.

**Materials:**

*Materials may be reported in part of a section or else they may be recognized along with your measures.*

**Methods:**

- Report the method and not the particulars of each process that engaged the same methodology.
- Describe the method entirely.
- To be succinct, present methods under headings dedicated to specific dealings or groups of measures.
- Simplify—detail how procedures were completed, not how they were performed on a particular day.
- If well-known procedures were used, account for the procedure by name, possibly with a reference, and that's all.

**Approach:**

It is embarrassing to use vigorous voice when documenting methods without using first person, which would focus the reviewer's interest on the researcher rather than the job. As a result, when writing up the methods, most authors use third person passive voice.

Use standard style in this and every other part of the paper—avoid familiar lists, and use full sentences.

**What to keep away from:**

- Resources and methods are not a set of information.
- Skip all descriptive information and surroundings—save it for the argument.
- Leave out information that is immaterial to a third party.

**Results:**

The principle of a results segment is to present and demonstrate your conclusion. Create this part as entirely objective details of the outcome, and save all understanding for the discussion.

The page length of this segment is set by the sum and types of data to be reported. Use statistics and tables, if suitable, to present consequences most efficiently.

You must clearly differentiate material which would usually be incorporated in a study editorial from any unprocessed data or additional appendix matter that would not be available. In fact, such matters should not be submitted at all except if requested by the instructor.



**Content:**

- Sum up your conclusions in text and demonstrate them, if suitable, with figures and tables.
- In the manuscript, explain each of your consequences, and point the reader to remarks that are most appropriate.
- Present a background, such as by describing the question that was addressed by creation of an exacting study.
- Explain results of control experiments and give remarks that are not accessible in a prescribed figure or table, if appropriate.
- Examine your data, then prepare the analyzed (transformed) data in the form of a figure (graph), table, or manuscript.

**What to stay away from:**

- Do not discuss or infer your outcome, report surrounding information, or try to explain anything.
- Do not include raw data or intermediate calculations in a research manuscript.
- Do not present similar data more than once.
- A manuscript should complement any figures or tables, not duplicate information.
- Never confuse figures with tables—there is a difference.

**Approach:**

As always, use past tense when you submit your results, and put the whole thing in a reasonable order.

Put figures and tables, appropriately numbered, in order at the end of the report.

If you desire, you may place your figures and tables properly within the text of your results section.

**Figures and tables:**

If you put figures and tables at the end of some details, make certain that they are visibly distinguished from any attached appendix materials, such as raw facts. Whatever the position, each table must be titled, numbered one after the other, and include a heading. All figures and tables must be divided from the text.

**Discussion:**

The discussion is expected to be the trickiest segment to write. A lot of papers submitted to the journal are discarded based on problems with the discussion. There is no rule for how long an argument should be.

Position your understanding of the outcome visibly to lead the reviewer through your conclusions, and then finish the paper with a summing up of the implications of the study. The purpose here is to offer an understanding of your results and support all of your conclusions, using facts from your research and generally accepted information, if suitable. The implication of results should be fully described.

Infer your data in the conversation in suitable depth. This means that when you clarify an observable fact, you must explain mechanisms that may account for the observation. If your results vary from your prospect, make clear why that may have happened. If your results agree, then explain the theory that the proof supported. It is never suitable to just state that the data approved the prospect, and let it drop at that. Make a decision as to whether each premise is supported or discarded or if you cannot make a conclusion with assurance. Do not just dismiss a study or part of a study as "uncertain."

Research papers are not acknowledged if the work is imperfect. Draw what conclusions you can based upon the results that you have, and take care of the study as a finished work.

- You may propose future guidelines, such as how an experiment might be personalized to accomplish a new idea.
- Give details of all of your remarks as much as possible, focusing on mechanisms.
- Make a decision as to whether the tentative design sufficiently addressed the theory and whether or not it was correctly restricted. Try to present substitute explanations if they are sensible alternatives.
- One piece of research will not counter an overall question, so maintain the large picture in mind. Where do you go next? The best studies unlock new avenues of study. What questions remain?
- Recommendations for detailed papers will offer supplementary suggestions.



**Approach:**

When you refer to information, differentiate data generated by your own studies from other available information. Present work done by specific persons (including you) in past tense.

Describe generally acknowledged facts and main beliefs in present tense.

## THE ADMINISTRATION RULES

Administration Rules to Be Strictly Followed before Submitting Your Research Paper to Global Journals Inc.

*Please read the following rules and regulations carefully before submitting your research paper to Global Journals Inc. to avoid rejection.*

*Segment draft and final research paper:* You have to strictly follow the template of a research paper, failing which your paper may get rejected. You are expected to write each part of the paper wholly on your own. The peer reviewers need to identify your own perspective of the concepts in your own terms. Please do not extract straight from any other source, and do not rephrase someone else's analysis. Do not allow anyone else to proofread your manuscript.

*Written material:* You may discuss this with your guides and key sources. Do not copy anyone else's paper, even if this is only imitation, otherwise it will be rejected on the grounds of plagiarism, which is illegal. Various methods to avoid plagiarism are strictly applied by us to every paper, and, if found guilty, you may be blacklisted, which could affect your career adversely. To guard yourself and others from possible illegal use, please do not permit anyone to use or even read your paper and file.



CRITERION FOR GRADING A RESEARCH PAPER (COMPILATION)  
BY GLOBAL JOURNALS

Please note that following table is only a Grading of "Paper Compilation" and not on "Performed/Stated Research" whose grading solely depends on Individual Assigned Peer Reviewer and Editorial Board Member. These can be available only on request and after decision of Paper. This report will be the property of Global Journals.

Topics	Grades		
	A-B	C-D	E-F
<i>Abstract</i>	Clear and concise with appropriate content, Correct format. 200 words or below	Unclear summary and no specific data, Incorrect form  Above 200 words	No specific data with ambiguous information  Above 250 words
<i>Introduction</i>	Containing all background details with clear goal and appropriate details, flow specification, no grammar and spelling mistake, well organized sentence and paragraph, reference cited	Unclear and confusing data, appropriate format, grammar and spelling errors with unorganized matter	Out of place depth and content, hazy format
<i>Methods and Procedures</i>	Clear and to the point with well arranged paragraph, precision and accuracy of facts and figures, well organized subheads	Difficult to comprehend with embarrassed text, too much explanation but completed	Incorrect and unorganized structure with hazy meaning
<i>Result</i>	Well organized, Clear and specific, Correct units with precision, correct data, well structuring of paragraph, no grammar and spelling mistake	Complete and embarrassed text, difficult to comprehend	Irregular format with wrong facts and figures
<i>Discussion</i>	Well organized, meaningful specification, sound conclusion, logical and concise explanation, highly structured paragraph reference cited	Wordy, unclear conclusion, spurious	Conclusion is not cited, unorganized, difficult to comprehend
<i>References</i>	Complete and correct format, well organized	Beside the point, Incomplete	Wrong format and structuring





# INDEX

---

---

## **B**

Borehole · 13, 18

---

## **F**

Fusion · 12

---

## **I**

Ignited · 12  
Irreplaceable · 24

---

## **K**

Karlsruhe · 18

---

## **L**

Lubricant · 9

---

## **P**

Pneumatic · 7, 11

---

## **R**

Rehabilitation · 3, 4, 24, 27

---

## **S**

Scaffolding · 7, 21

---

## **Y**

Yielded · 11

---

## **T**

Tonnage · 20, 21

---

## **V**

Viaducts · 9



save our planet



# Global Journal of Researches in Engineering

Visit us on the Web at [www.GlobalJournals.org](http://www.GlobalJournals.org) | [www.EngineeringResearch.org](http://www.EngineeringResearch.org)  
or email us at [helpdesk@globaljournals.org](mailto:helpdesk@globaljournals.org)

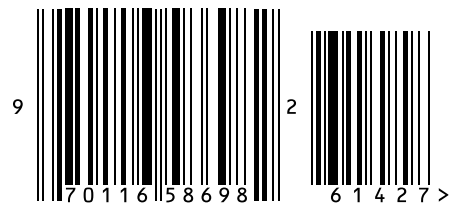

ISSN 9755861

© Global Journals