

GLOBAL JOURNAL

OF RESEARCHES IN ENGINEERING: J

General Engineering

Bioremediation of Oil-Spilled

Automatic Fire Fighting System

} Highlights {

Optimization and Improvement

Underwater Objects Technology

Discovering Thoughts, Inventing Future

VOLUME 19 ISSUE 5 VERSION 1.0



GLOBAL JOURNAL OF RESEARCHES IN ENGINEERING: J
GENERAL ENGINEERING



GLOBAL JOURNAL OF RESEARCHES IN ENGINEERING: J
GENERAL ENGINEERING

VOLUME 19 ISSUE 5 (VER. 1.0)

OPEN ASSOCIATION OF RESEARCH SOCIETY

© Global Journal of
Researches in Engineering.
2019.

All rights reserved.

This is a special issue published in version 1.0
of "Global Journal of Researches in
Engineering." By Global Journals Inc.

All articles are open access articles distributed
under "Global Journal of Researches in
Engineering"

Reading License, which permits restricted use.
Entire contents are copyright by of "Global
Journal of Researches in Engineering" unless
otherwise noted on specific articles.

No part of this publication may be reproduced
or transmitted in any form or by any means,
electronic or mechanical, including
photocopy, recording, or any information
storage and retrieval system, without written
permission.

The opinions and statements made in this
book are those of the authors concerned.
Ultraculture has not verified and neither
confirms nor denies any of the foregoing and
no warranty or fitness is implied.

Engage with the contents herein at your own
risk.

The use of this journal, and the terms and
conditions for our providing information, is
governed by our Disclaimer, Terms and
Conditions and Privacy Policy given on our
website [http://globaljournals.us/terms-and-condition/
menu-1463/](http://globaljournals.us/terms-and-condition/menu-1463/).

By referring / using / reading / any type of
association / referencing this journal, this
signifies and you acknowledge that you have
read them and that you accept and will be
bound by the terms thereof.

All information, journals, this journal,
activities undertaken, materials, services and
our website, terms and conditions, privacy
policy, and this journal is subject to change
anytime without any prior notice.

Incorporation No.: 0423089
License No.: 42125/022010/1186
Registration No.: 430374
Import-Export Code: 1109007027
Employer Identification Number (EIN):
USA Tax ID: 98-0673427

Global Journals Inc.

(A Delaware USA Incorporation with "Good Standing"; Reg. Number: 0423089)

Sponsors: Open Association of Research Society

Open Scientific Standards

Publisher's Headquarters office

Global Journals® Headquarters
945th Concord Streets,
Framingham Massachusetts Pin: 01701,
United States of America

USA Toll Free: +001-888-839-7392

USA Toll Free Fax: +001-888-839-7392

Offset Typesetting

Global Journals Incorporated
2nd, Lansdowne, Lansdowne Rd., Croydon-Surrey,
Pin: CR9 2ER, United Kingdom

Packaging & Continental Dispatching

Global Journals Pvt Ltd
E-3130 Sudama Nagar, Near Gopur Square,
Indore, M.P., Pin:452009, India

Find a correspondence nodal officer near you

To find nodal officer of your country, please
email us at local@globaljournals.org

eContacts

Press Inquiries: press@globaljournals.org
Investor Inquiries: investors@globaljournals.org
Technical Support: technology@globaljournals.org
Media & Releases: media@globaljournals.org

Pricing (Excluding Air Parcel Charges):

Yearly Subscription (Personal & Institutional)
250 USD (B/W) & 350 USD (Color)

EDITORIAL BOARD

GLOBAL JOURNAL OF RESEARCH IN ENGINEERING

Dr. Ren-Jye Dzeng

Professor Civil Engineering, National Chiao-Tung University, Taiwan Dean of General Affairs, Ph.D., Civil & Environmental Engineering, University of Michigan United States

Dr. Iman Hajirasouliha

Ph.D. in Structural Engineering, Associate Professor, Department of Civil and Structural Engineering, University of Sheffield, United Kingdom

Dr. Ye Tian

Ph.D. Electrical Engineering The Pennsylvania State University 121 Electrical, Engineering East University Park, PA 16802, United States

Dr. Eric M. Lui

Ph.D., Structural Engineering, Department of Civil & Environmental Engineering, Syracuse University United States

Dr. Zi Chen

Ph.D. Department of Mechanical & Aerospace Engineering, Princeton University, US Assistant Professor, Thayer School of Engineering, Dartmouth College, Hanover, United States

Dr. T.S. Jang

Ph.D. Naval Architecture and Ocean Engineering, Seoul National University, Korea Director, Arctic Engineering Research Center, The Korea Ship and Offshore Research Institute, Pusan National University, South Korea

Dr. Ephraim Suhir

Ph.D., Dept. of Mechanics and Mathematics, Moscow University Moscow, Russia Bell Laboratories Physical Sciences and Engineering Research Division United States

Dr. Pangil Choi

Ph.D. Department of Civil, Environmental, and Construction Engineering, Texas Tech University, United States

Dr. Xianbo Zhao

Ph.D. Department of Building, National University of Singapore, Singapore, Senior Lecturer, Central Queensland University, Australia

Dr. Zhou Yufeng

Ph.D. Mechanical Engineering & Materials Science, Duke University, US Assistant Professor College of Engineering, Nanyang Technological University, Singapore

Dr. Pallav Purohit

Ph.D. Energy Policy and Planning, Indian Institute of Technology (IIT), Delhi Research Scientist, International Institute for Applied Systems Analysis (IIASA), Austria

Dr. Balasubramani R

Ph.D., (IT) in Faculty of Engg. & Tech. Professor & Head, Dept. of ISE at NMAM Institute of Technology

Dr. Sofoklis S. Makridis

B.Sc(Hons), M.Eng, Ph.D. Professor Department of Mechanical Engineering University of Western Macedonia, Greece

Dr. Steffen Lehmann

Faculty of Creative and Cultural Industries Ph.D., AA Dip University of Portsmouth United Kingdom

Dr. Wenfang Xie

Ph.D., Department of Electrical Engineering, Hong Kong Polytechnic University, Department of Automatic Control, Beijing University of Aeronautics and Astronautics China

Dr. Hai-Wen Li

Ph.D., Materials Engineering, Kyushu University, Fukuoka, Guest Professor at Aarhus University, Japan

Dr. Saeed Chehreh Chelgani

Ph.D. in Mineral Processing University of Western Ontario, Adjunct professor, Mining engineering and Mineral processing, University of Michigan United States

Belen Riveiro

Ph.D., School of Industrial Engineering, University of Vigo Spain

Dr. Adel Al Jumaily

Ph.D. Electrical Engineering (AI), Faculty of Engineering and IT, University of Technology, Sydney

Dr. Maciej Gućma

Assistant Professor, Maritime University of Szczecin Szczecin, Ph.D.. Eng. Master Mariner, Poland

Dr. M. Meguellati

Department of Electronics, University of Batna, Batna 05000, Algeria

Dr. Haijian Shi

Ph.D. Civil Engineering Structural Engineering Oakland, CA, United States

Dr. Chao Wang

Ph.D. in Computational Mechanics Rosharon, TX, United States

Dr. Joaquim Carneiro

Ph.D. in Mechanical Engineering, Faculty of Engineering, University of Porto (FEUP), University of Minho, Department of Physics Portugal

Dr. Wei-Hsin Chen

Ph.D., National Cheng Kung University, Department of Aeronautics, and Astronautics, Taiwan

Dr. Bin Chen

B.Sc., M.Sc., Ph.D., Xian Jiaotong University, China. State Key Laboratory of Multiphase Flow in Power Engineering Xi'an Jiaotong University, China

Dr. Charles-Darwin Annan

Ph.D., Professor Civil and Water Engineering University Laval, Canada

Dr. Jalal Kafashan

Mechanical Engineering Division of Mechatronics KU Leuven, Belgium

Dr. Alex W. Dawotola

Hydraulic Engineering Section, Delft University of Technology, Stevinweg, Delft, Netherlands

Dr. Shun-Chung Lee

Department of Resources Engineering, National Cheng Kung University, Taiwan

Dr. Gordana Colovic

B.Sc Textile Technology, M.Sc. Technical Science Ph.D. in Industrial Management. The College of Textile? Design, Technology and Management, Belgrade, Serbia

Dr. Giacomo Risitano

Ph.D., Industrial Engineering at University of Perugia (Italy) "Automotive Design" at Engineering Department of Messina University (Messina) Italy

Dr. Maurizio Palesi

Ph.D. in Computer Engineering, University of Catania, Faculty of Engineering and Architecture Italy

Dr. Salvatore Brischetto

Ph.D. in Aerospace Engineering, Polytechnic University of Turin and in Mechanics, Paris West University Nanterre La Defense Department of Mechanical and Aerospace Engineering, Polytechnic University of Turin, Italy

Dr. Wesam S. Alaloul

B.Sc., M.Sc., Ph.D. in Civil and Environmental Engineering, University Technology Petronas, Malaysia

Dr. Ananda Kumar Palaniappan

B.Sc., MBA, MED, Ph.D. in Civil and Environmental Engineering, Ph.D. University of Malaya, Malaysia, University of Malaya, Malaysia

Dr. Hugo Silva

Associate Professor, University of Minho, Department of Civil Engineering, Ph.D., Civil Engineering, University of Minho Portugal

Dr. Fausto Gallucci

Associate Professor, Chemical Process Intensification (SPI), Faculty of Chemical Engineering and Chemistry Assistant Editor, International J. Hydrogen Energy, Netherlands

Dr. Philip T Moore

Ph.D., Graduate Master Supervisor School of Information Science and engineering Lanzhou University China

Dr. Cesar M. A. Vasques

Ph.D., Mechanical Engineering, Department of Mechanical Engineering, School of Engineering, Polytechnic of Porto Porto, Portugal

Dr. Jun Wang

Ph.D. in Architecture, University of Hong Kong, China Urban Studies City University of Hong Kong, China

Dr. Stefano Invernizzi

Ph.D. in Structural Engineering Technical University of Turin, Department of Structural, Geotechnical and Building Engineering, Italy

Dr. Togay Ozbakkaloglu

B.Sc. in Civil Engineering, Ph.D. in Structural Engineering, University of Ottawa, Canada Senior Lecturer University of Adelaide, Australia

Dr. Zhen Yuan

B.E., Ph.D. in Mechanical Engineering University of Sciences and Technology of China, China Professor, Faculty of Health Sciences, University of Macau, China

Dr. Jui-Sheng Chou

Ph.D. University of Texas at Austin, U.S.A. Department of Civil and Construction Engineering National Taiwan University of Science and Technology (Taiwan Tech)

Dr. Houfa Shen

Ph.D. Manufacturing Engineering, Mechanical Engineering, Structural Engineering, Department of Mechanical Engineering, Tsinghua University, China

Prof. (LU), (UoS) Dr. Miklas Scholz

Cand Ing, BEng (equiv), PgC, MSc, Ph.D., CWEM, CEnv, CSci, CEng, FHEA, FIEMA, FCIWEM, FICE, Fellow of IWA, VINNOVA Fellow, Marie Curie Senior, Fellow, Chair in Civil Engineering (UoS) Wetland Systems, Sustainable Drainage, and Water Quality

Dr. Yudong Zhang

B.S., M.S., Ph.D. Signal and Information Processing, Southeast University Professor School of Information Science and Technology at Nanjing Normal University, China

Dr. Minghua He

Department of Civil Engineering Tsinghua University Beijing, 100084, China

Dr. Philip G. Moscoso

Technology and Operations Management IESE Business School, University of Navarra Ph.D. in Industrial Engineering and Management, ETH Zurich M.Sc. in Chemical Engineering, ETH Zurich, Spain

Dr. Stefano Mariani

Associate Professor, Structural Mechanics, Department of Civil and Environmental Engineering, Ph.D., in Structural Engineering Polytechnic University of Milan Italy

Dr. Francesco Tornabene

Ph.D. in Structural Mechanics, University of Bologna Professor Department of Civil, Chemical, Environmental and Materials Engineering University of Bologna, Italy

Dr. Ciprian Lapusan

Ph. D in Mechanical Engineering Technical University of Cluj-Napoca Cluj-Napoca (Romania)

Dr. Kitipong Jaorjuek

B. Eng, M. Eng, D. Eng (Energy Technology, Asian Institute of Technology). Kasetsart University Kamphaeng Saen (KPS) Campus Energy Research Laboratory of Mechanical Engineering

Dr. Burcin Becerik-Gerber

University of Southern California Ph.D. in Civil Engineering Ddes, from Harvard University M.S. from University of California, Berkeley M.S. from Istanbul, Technical University

Hiroshi Sekimoto

Professor Emeritus Tokyo Institute of Technology Japan Ph.D., University of California Berkeley

Dr. Shaoping Xiao

BS, MS Ph.D. Mechanical Engineering, Northwestern University The University of Iowa, Department of Mechanical and Industrial Engineering Center for Computer-Aided Design

Dr. A. Stegou-Sagia

Ph.D., Mechanical Engineering, Environmental Engineering School of Mechanical Engineering, National Technical University of Athens, Greece

Diego Gonzalez-Aguilera

Ph.D. Dep. Cartographic and Land Engineering, University of Salamanca, Avilla, Spain

Diego Gonzalez-Aguilera

Ph.D. Dep. Cartographic and Land Engineering, University of Salamanca, Avilla, Spain

Dr. Paolo Veronesi

Ph.D., Materials Engineering, Institute of Electronics,
Italy President of the master Degree in Materials
Engineering Dept. of Engineering, Italy

Dr. Omid Gohardani

Ph.D. Senior Aerospace/Mechanical/ Aeronautical,
Engineering professional M.Sc. Mechanical Engineering,
M.Sc. Aeronautical Engineering B.Sc. Vehicle
Engineering Orange County, California, US

Dr. Maria Daniela

Ph.D in Aerospace Science and Technologies Second
University of Naples, Research Fellow University of Naples
Federico II, Italy

Dr. Fentahun Moges Kasie

Department of mechanical & Industrial Engineering,
Institute, of technology Hawassa University Hawassa,
Ethiopia

CONTENTS OF THE ISSUE

- i. Copyright Notice
 - ii. Editorial Board Members
 - iii. Chief Author and Dean
 - iv. Contents of the Issue
-
1. Cleaning of Underwater Objects Technology. *1-9*
 2. Proportional Optimization of Cow Dung and Cow Bone Char for Bioremediation of Crude Oil Polluted Soil. *11-21*
 3. Design, Construction and Performance Test of an Automatic Fire Fighting System. *23-30*
 4. Use of the Split Hopkinson Pressure Bar on Performance Evaluation of Polymer Composites for Ballistic Protection Purposes. *31-39*
-
- v. Fellows
 - vi. Auxiliary Memberships
 - vii. Preferred Author Guidelines
 - viii. Index



GLOBAL JOURNAL OF RESEARCHES IN ENGINEERING: J
GENERAL ENGINEERING
Volume 19 Issue 5 Version 1.0 Year 2019
Type: Double Blind Peer Reviewed International Research Journal
Publisher: Global Journals
Online ISSN: 2249-4596 & Print ISSN: 0975-5861

Cleaning of Underwater Objects Technology

By Doktor Rodionov Viktor

Introduction- The uniquely designed and patented *Cavimax Technology And Equipment* is developed to clean underwater surfaces:

- Sea-craft, ships and freshwater vessels of different glass (tankers, dry cargo ships, yachts, cutters) ;
- Stationary hydro-technical structures (piers, moles, moorages);
- Sea platforms for various purposes (oil, gas extraction);
- Pipelines and other stationary submarine objects.

Underwater cleaning *CAVIMAX TECHNOLOGY* is based on the cavitation effect and is used for qualitative and high-speed destruction and removing of marine growth of any thickness (seaweed, shells, corals)', rust and peeling paint without damaging the hull and a protective coating. The surface can be cleaned Passive voice to bare metal with the help of the operating mode selection of the cavitating stream.

GJRE-J Classification: FOR Code: 291899



Strictly as per the compliance and regulations of:



Cleaning of Underwater Objects Technology

Doktor Rodionov Viktor

I. INTRODUCTION

The uniquely designed and patented *Cavimax Technology And Equipment* is developed to clean underwater surfaces:

- Sea-craft, ships and freshwater vessels of different class (tankers, dry cargo ships, yachts, cutters) ;
- Stationary hydro-technical structures (piers, moles, moorages);
- Sea platforms for various purposes (oil, gas extraction);
- Pipelines and other stationary submarine objects.

Underwater cleaning *CAVIMAX TECHNOLOGY* is based on the cavitation effect and is used for qualitative and high-speed destruction and removing of marine growth of any thickness (seaweed, shells, corals), rust and peeling paint without damaging the hull and a protective coating. The surface can be cleaned Passive voice to bare metal with the help of the operating mode selection of the cavitating stream.

The *CAVIMAX EQUIPMENT* uses outboard sea or river water creating a speed cavitation max with microscopic Unusual word pair steam Possibly confused word of bubbles under 150- 250 Bar with a capacity of 200 l/min (standard pumping plants). Upon contact with the surface being cleaned Passive voice, these bubbles implode. The result of the microscopic bubbles imploding is the destruction of marine growth, rust and, its removal from the work area. During this process, the working pressure reaches up to 10,000 Bar at the cleaned area.

The newest *CAVIMAX-technology* uses the *SPECIAL CAVIMAX CLEANING SYSTEMS*:

- Hand-held diving climax pistols for cleaning curved and hard-to-get surfaces with a cleaning rate up to 250-350 m²/hour (equipped with or the jet nozzle for compensating recoil and power level control);
- Semi-automatic self-propelled climax heads of various types for cleaning flat surfaces for different thicknesses of marine growth and a cleaning rate up to 1200- 1500 m²/hour (equipped with adjustable climax automatic propulsion, or the hydrodynamic suction system to clean objects and remove waste from the work area, speed adjustment, and power level control);
- Remote-controlled programmable climax cleaning devices with improved productivity (pilot designs);
- Unique Repetitive word: devices for post-cleaning

polishing of the underwater hull (for curved and flat surfaces);

- Underwater telemetry and video control of the process;
- Remote above-water control of operating devices is available.

The complete equipment package - self-sufficient, modular, mobile - is formed depending on production requirements and user's needs.

EFFECTIVENESS AND INNOVATION of underwater hull cleaning climax equipment:

- Highly efficient and qualitative cleaning (up to 2500 m²/hour) of vessels without docking;
- Rapid cleaning (up to 1000 m²/hour) of curved and hard-to-get surfaces (propellers, rudders, Kingston, supports of hydro-technical structures, pipelines);
- Safety for divers;
- No damage to paint and varnish coatings of surfaces cleaned;
- No need for periodic replacement of tools and consumables during operation;
- Uninterrupted round-the-clock running;
- Cleans any surfaces (metal, aluminum, plastic, wood, concrete, etc.);
- High maintainability and reliability during the long-term;
- Choice of level, speed and cleaning modes (the hull can Repetitive word: cleaned Passive voice to bare metal) ;
- Application of standard above-water pumping utilities (150-200 l/min, 150-250 bar);
- Remote above-water control (including programmable control).

The newest *UNDERWATER CLEANING CAVIMAX TECHNOLOGY AND EQUIPMENT* drastically enhances labor productivity and quality. Cavimax technology makes cleaning services highly cost-effective in today's market.

1. Of the underwater accretion elimination technologies using the mechanic brushes (like "Sea Brush") and the Possibly miswritten world instrument series *CAVIMAX*.

The proposed newest Possibly miswritten world technology developed and patented Viktor Rodionov (Russia) [3,4] exceeds the currently used technology, based on the implementation of hydraulic disc mechanical brushes, in many characteristics. Depending on the required productivity, devices with one, two, and three- disc brushes may be used Passive

voice. Out of the production of the PHOSMARINE company, being most wide-spread in the sphere of underwater cleansing, the Overused word "Sea Brush" mechanism with one disc brush weighs about 30 kg and has the productivity of 200-300m²/h while the Overused word mechanism with three-disc brushes "Brush Cart" weighs 170 kg and has the productivity of 1800 m²/h.

The Possibly miswritten word instrument of likewise productivity weighs 3 kg, correspondingly, whereas "Sea Brush" weighs 30 kg.

Divers, who cleanse the surfaces of the ships from accretion underwater, perform hard physical work, which requires oxygen consumption of 2.5 – 3.0 liters/minute, the heart rate is 140-160 b/m. Such activities may be performed Passive voice in daylight only.

On the other hand, due to the low weight and safety of the Possibly miswritten word instrument, divers

may perform their work with less physical effort at any time of the day.

It will take just one run of the instrument to cleanse the surface efficiently, unlike the brush devices, which require several Repetitive word for the same purpose.

One of the Overused word drawbacks of the brush devices is that they fail to function and shut down because of the water-plants rolled over the brush mechanism. Possibly miswritten word instruments Overused word cut all sorts of water-plants.

In Table 1 below you can see the comparative productivity indexes of the two cleansing methods for the tanker with the capacity of 50 000 tons and the under-water area of 10 000 m² (the comparison is between the one-brush mechanism "Sea Brush" with the productivity of 300 m²/h and the one cavitation instrument).

Table 1: Comparative data for the cleansing methods

INDEXES OF CLEANSING	METHODS OF CLEANSING	
	"Sea Brush"	device Supercavitation
Rated productivity, m ² /h	300	250
Actual productivity, m ² /h	100	250
Tanker cleansing time, h	100	40

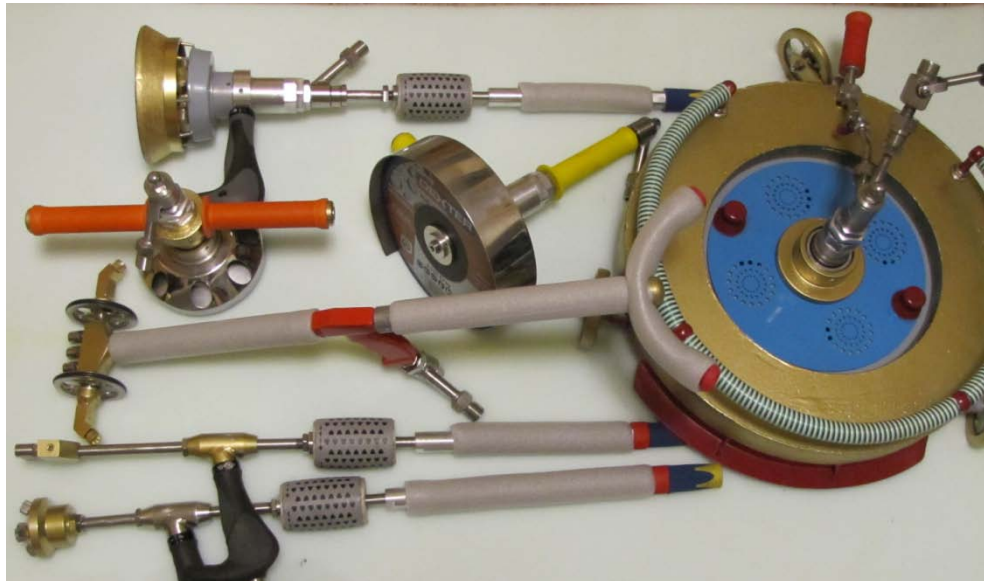

Possibly miswritten word instrument CaviMax.

The cavitation driver – "cavitator" is designed in such a way, that it is not damaged during work, as the supercavitation cavern is the working organ and consists of many steam-gas bubbles, which are formed Passive voice outside the cavitation cut.

The brushes require periodical Unusual word pair replacement due to wear ability. The cost of the brush depends on the construction and is in USD, as is shown in Table 2.

Table 2: The cost of the “Sea Brush” brushes, USD:

Nylon	45	for soft accretion
Steel	52	for soft accretion
Steel enhanced	95	for hard accretion
Steel stainless	130	for hard accretion
Special	770	for very hard accretion

The abilities and limitations in the application of the old and new technology for the cleansing of various surfaces underwater are given Passive voice in Table 3:

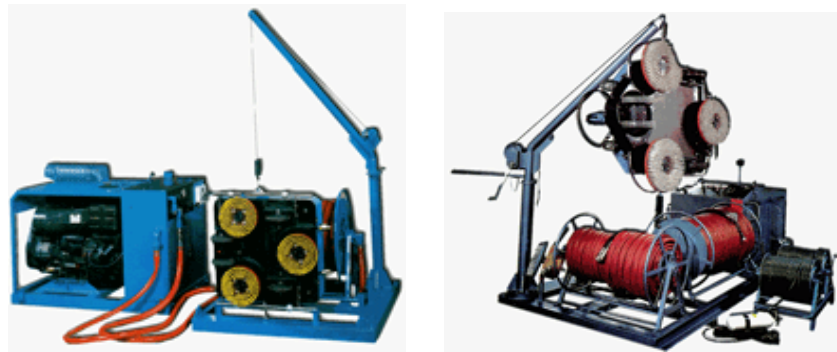

Brush kart

Table 3: Comparative capacity and limitations of the given technologies

Work, abilities, effects	Mechanical “Sea Brush” technologies	Possibly miswritten word device
Cleansing the ship frame to the “white metal”	Impossible	Possible, time of cleansing extended
Cleansing of the king stone grates	Limited	Simultaneous cleansing of all sides
Cleansing of the vint and helm group	Limited	Without loss of productivity
Cleansing of the underwater parts of the sea-platforms and installations	Impossible	Cleansing of all types
Cleansing yachts and boats	Limited	Efficient, the frame surface is not damaged
Cleansing small-size objects (devices) and objects with complicated surface	Impossible	Without loss of productivity
Number of runs for the instrument to perform the cleansing required	Several (depending on the type and rate of accretion)	One
Automation of the cleansing process	Very complicated technically	Realized by PTA installation
Cleansing pipes, internal surfaces of the overland industrial surfaces	Impossible	Possible
Damage of the protective covers	Inevitable	Absent
Environment pollution	Inevitable (toxic elements of ship paint, hydrogear oil)	Absent
Waste of materials and instrument wearability	Present (depending on the type and rate of accretion)	Absent

The comparative properties and productivity of various instruments are given Passive voice in Table 4.

Table 4: Comparative productivity data for various instruments

Category of accretion	Surfaces processed	Old technology m ² /h		New technology m ² /h	
		Scrubber		Sea Brush” head	Hydro pistol
I.	Side, bottom	25	800	1000	200
II.	Side, bottom	25	200	1000	200
III.	Side, bottom	10	100	800	150

	Vint, helm	2	25	-	150
	Kingstone grating	1	-	-	150
IV.	Side, bottom	4	-	600	100
	Vint, helm	0.5	-	-	100
	Kingstone grating	0.3	-	-	100

Table 5: Comparative data on the quality of the jobs performed

Cost of the job 10-15 \$/m ² "Sea Brush"	Cost of the job 1-5 \$/m ² Possibly miswritten word instrument
Damages costly protective paint-and-varnish, anticorrosion and antiaccretion coverings (on the weld seams) due to the contact of the instrument and the surface being cleansed.	Due to the selection of the cavitation flow parameters the accretion cleansing takes place without damaging the protective covering (In some cases cleansing may reach metal).
Requires periodical replacement of the mechanical cleansing elements (costly brushes and scrubbers), which makes the cleansing process slower and costlier.	Does not require replacement of the working elements (quant nozzles), cleansing may be performed in non-stop duration regimen.
Non-productive for thick accretion and some types of accretion (like major balanus and long water-plants).	Universal for accretion of any type and thickness.
Application in hard-to-reach spots is limited (vint and helm group, kingstone valves, grates, boxes etc.).	The instrument set allows efficient cleansing of all surfaces and hard-to-reach spots.
The use of hydrogears may cause leakage of oils and result in the environment contamination.	The technology is environment-friendly, as the overboard water is the single working material.



Possibly miswritten word instrument CaviMax.

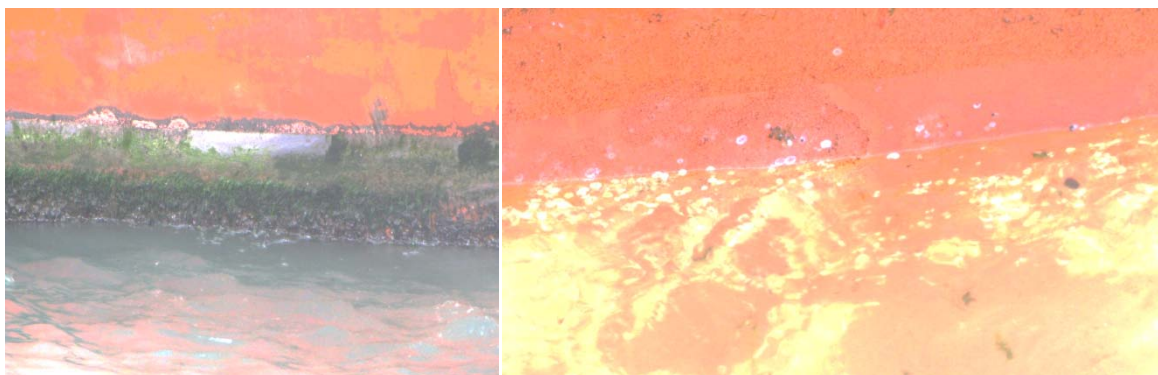

Efficient, the frame surface is not damaged.

2. Research and Development Enterprise BUSINESS PROPOSAL

Our company has been operating in the service market for four years already. We design, test, and manufacture plants that are used to clean parts of submerged centrifugal pumps. Our equipment is unparalleled in Russia [1, 2] and the entire world. (The company has an industrial patent "Parts Cleaning Method and the Device Used for Such Cleaning"; the engineering documents and test certificates compliant with the All-Union Standards are also available).

The unit is designed based on the newest environmentally friendly technology unparalleled in the world with a special Overused word emphasis on today's efficiency and quality requirements.

The technology used in the proposed unit is hugely advantageous if compared to the more commonly known one that is often applied at repair facilities in Russia and in other countries of the world. The disadvantages of the conventional technology Possibly confused word include the following:

First of all, a commonly known technology Repetitive word involves corrosive and erosive wear of the parts' surface and its undesirable deformation. The parts cleaned in this way are, as a result, quickly discarded. Secondly, the amount of power consumed increases immensely when the parts are cleaned Passive voice. And thirdly, the cleaning efficiency with the technology is rather low.

The proposed Unusual word pair technology eliminates all of the listed drawbacks because the working substance here is water and supercavitation steam-and-gas air bubbles. The cleaning efficiency offered by this technology lies within the range of 50-60 thousand parts per month, provided that the plant is operated Passive voice in two shifts. The plant is a universal semiautomatic device that helps clean pump irrespective of their configuration. The cleaning is performed to 100% at both the inner and outer surface of the Repetitive word with no further cleaning required. The flow diagram of the plant is shown Passive voice in Figure 1.



Устройство чистки	Cleaning device
Блок очистки воды с первым ГЦ	Water treatment unit with the first cyclone
Емкость оборотной воды со вторым ГЦ	Recycled water reservoir with the second cyclone
Насос подпитки	Delivery pump
Установка насосная УНГ-1 75/40	Pumping plant UNG-1 75/40
мм	Mm
Слив твердых частиц грязи	Dump of solid impurities
Приемная емкость для масляной воды	Oily water receiving tank
кВт	kW
В	V
Слив воды в канализацию	Water dump into sewage
Слив масляного пятна из кармана емкости	Oil patch dump from the tank's pool
Подача воды из системы водоснабжения	Water feed from the water supply system

Труба	Pipe
Перелив воды	Water overflow
Масляная пленка	Oil film
Вода высокого давления	High-pressure water
Возврат излишков воды от насоса	Return of extra water from the pump

Parts are cleaned using the developed and patented environmentally friendly technology with the help of supercavitation flows that originate from the system of patented Repetitive word cavitation agents.

The Plant is unique in the way its *environmental friendliness* is achieved Passive voice. The whole principle is based on the *recycled water* that acts as a

working cleaning agent, which, after it is used Passive voice, passes through the multi-stage filtration system specially designed for this plant, is then freed from solid impurities, oily additives and paraffin that are collected Passive voice in Overused word tanks, and finally recycled.



Figure 2: General Plant View.



Figure 3: Water Treatment System.



Figure 4: Control Boar.

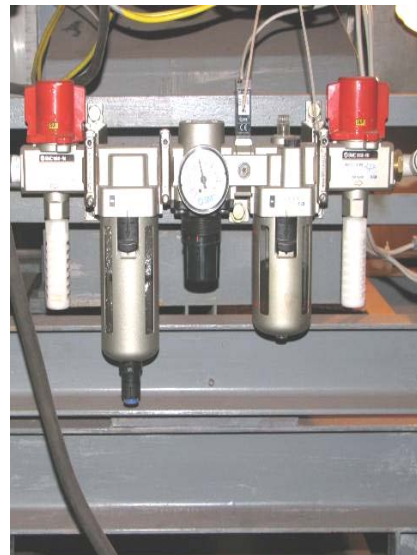

Figure 5: Control Unit.



Figure 6: High-Lift Pump.



Figure 7: Cavitation Agents Unit.



Figure 8: Control over Operation of the Plant's Systems.



Figure 9: Loading of Contaminated Parts for Cleaning and Unloading the Cleaned Parts.



Figure 10: Recycled Water in a Tank after the Parts Have Been Cleaned



Figure 11: Recycled Water in a Tank after Cleaning in the Filtration System

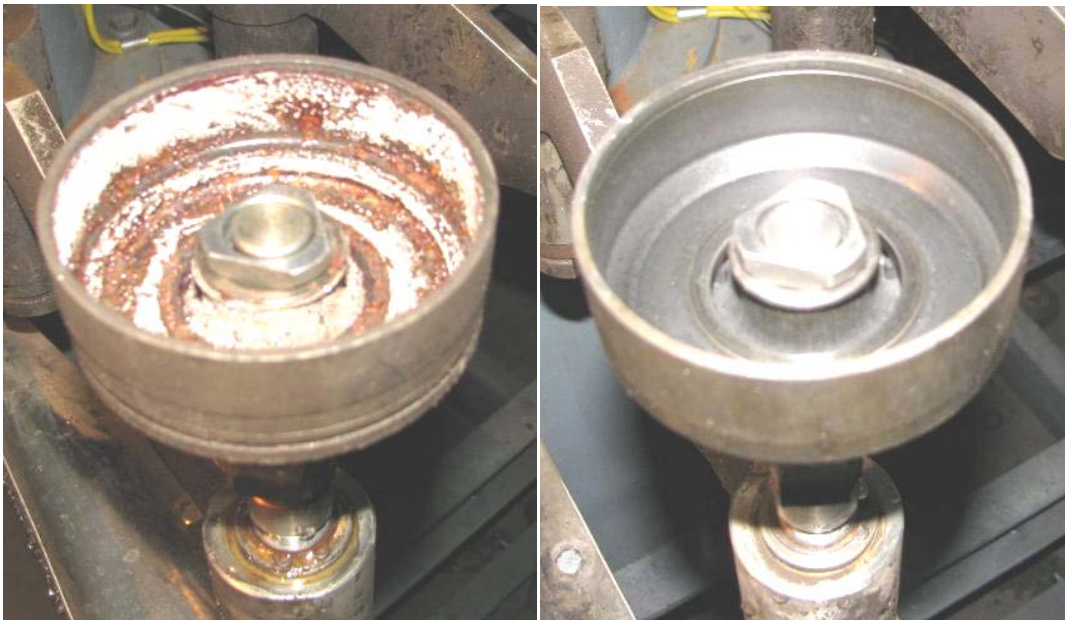

Figure 12: Solid Impurities Collection Tank



Figure 13: Pump Parts in the Plant Before and After Cleaning

LITERATURE

1. A. S.1829431. USSR, MKI. C23G1/00. Cleaning method of steel products /V. P. Rodionov,
2. Patent No.1614241, Russia MKI, In 0F /00, In 08 B 03/12. Hydrocavitation Generator Rodionov V.P.
3. Patent for invention No. 2376193 RU, Hydrodynamic cleaning of surfaces of objects under water and device for its implementation/Rodionov V. P.
4. Patent for Invention No. 2568467 RU, Kavitor Rodionova V. P./Rodionov V.P.



This page is intentionally left blank



GLOBAL JOURNAL OF RESEARCHES IN ENGINEERING: J
GENERAL ENGINEERING
Volume 19 Issue 5 Version 1.0 Year 2019
Type: Double Blind Peer Reviewed International Research Journal
Publisher: Global Journals
Online ISSN: 2249-4596 & Print ISSN: 0975-5861

Proportional Optimization of Cow Dung and Cow Bone Char for Bioremediation of Crude Oil Polluted Soil

By Baniviga, Tombari Barimme, Momoh, O.L, Yusuf & Ibiba Taiwo Horsfall

University of Port-Harcourt Choba

Abstract- In this research, attempts were made to study the effects of cow dung and cow bone char mixture for bioremediation of crude oil-polluted soil. This process of remediation was conducted ex-situ using an optimization technique termed three-level design with two factors - 3^2 design factorial. The first-order kinetics was also employed in studying the kinetics of degradation with the observed correlation of determination (R^2) between (0.726 - 0.969). The optimization technique shows also that the optimal mix range between 20 – 38% for cow dung and 35 -50% for bone char. In terms of mass, this translates to an optimal mix of 30-57g of cow dung and 52.5 – 75g of bone char for every 2kg of soil having a 4% crude oil contamination relative to the total mass of the mixture.

Keywords: cow dung; cow bone char, optimization; bioremediation; crude oil polluted soil.

GJRE-J Classification: FOR Code: 091599, 090799



Strictly as per the compliance and regulations of:



© 2019. Baniviga, Tombari Barimme, Momoh, O.L, Yusuf & Ibiba Taiwo Horsfall. This is a research/review paper, distributed under the terms of the Creative Commons Attribution-Noncommercial 3.0 Unported License (<http://creativecommons.org/licenses/by-nc/3.0/>), permitting all non commercial use, distribution, and reproduction in any medium, provided the original work is properly cited.

Proportional Optimization of Cow Dung and Cow Bone Char for Bioremediation of Crude Oil Polluted Soil

Baniviga, Tombari Barimme^α, Momoh, O.L, Yusuf^σ & Ibiba Taiwo Horsfall^ρ

Abstract- In this research, attempts were made to study the effects of cow dung and cow bone char mixture for bioremediation of crude oil-polluted soil. This process of remediation was conducted ex-situ using an optimization technique termed three-level design with two factors - 3² design factorial. The first-order kinetics was also employed in studying the kinetics of degradation with the observed correlation of determination (R^2) between (0.726 - 0.969). The optimization technique shows also that the optimal mix range between 20 – 38% for cow dung and 35 -50% for bone char. In terms of mass, this translates to an optimal mix of 30-57g of cow dung and 52.5 – 75g of bone char for every 2kg of soil having a 4% crude oil contamination relative to the total mass of the mixture.

Keywords: cow dung; cow bone char, optimization; bioremediation; crude oil polluted soil.

I. INTRODUCTION

Bioremediation is a treatment process that uses microorganisms (yeast, fungi, or bacteria) to degrade or break down hazardous substances into less toxic or nontoxic substances. (Walter et al, 1997) also defined soil bioremediation as the process in which most of the organic pollutants are decomposed by soil microorganisms and converted to harmless end products such as carbon dioxide (CO₂), methane (CH₄) and water (H₂O). Soil microorganisms play a major role in soil bioremediation as biogeochemical agents to transform complex organic compounds into their constituent elements or into simple inorganic compounds. This process is termed mineralization. The microorganisms are adsorbed to the soil particles by the mechanism of ionic exchange. Generally, soil particles have a negative charge, and soil and bacteria can be held together by an ionic bond involving polyvalent cations (Killham, 1994). The question of the best method that should be used in oil-polluted lands depends on the biological, chemical and physical properties of both contaminants and soil. A variety of techniques had been successfully used for the cleanup of soil and groundwater contaminated with petroleum hydrocarbons, they include pump and treat of groundwater, excavation of shallow contaminated soils,

Author α σ: Department of Civil & Environmental Engineering, University of Port-Harcourt Choba, P.M.B 5323 Rivers State, Nigeria.

e-mail: yusuf.momoh@uniport.edu.ng

Author ρ: Department of Agricultural and Bioresources Engineering, Michael Okpara University of Agriculture, Abia State, Nigeria.

and vapor extraction, etc. Efforts to remediate the negative impact of hydrocarbon pollution on the soil have resulted in several devices such as Remediation by Enhanced Natural Attenuation (RENA) which is a Land farming technique, bio-stimulation and bio-augmentation of soil biota with commercially available micro flora. RENA is a soil treatment technique commonly used, it is a full-scale bioremediation technology in which contaminated soils, sediments, and sludges are periodically tilled or turned over into the soil to aerate the waste. Soil conditions are often controlled to increase the degradation rate of the contaminant (Odu, 1978, Gradi, 1985; EPA, 1994). RENA has limitations which include the inability to properly degrade crude oil that had spilled deeply down the soil strata.

II. MATERIALS AND METHODS

a) Sample collection

A polluted soil sample was collected using a shovel at a sample depth of 0-15cm and from three different points. The three soil samples were mixed and transported to Plant Anatomy and Physiology Research Laboratory of the University of Port-Harcourt for bioremediation. The cow dung was collected from the cowshed in the faculty of Agriculture farm site, the University of Port Harcourt and the cow bone was collected at Mgbuoba from a cow meat seller. The cow bone was taken to the University of Port Harcourt where it was crushed and burnt in a furnace. The cow dung was sun-dried for five days to drive off moisture. The soil sample was taken ex-situ from Bodo city, Gokana local government Area of Rivers State.

b) Ex-situ bioremediation procedure

The soil in the environment of the study has a previous history of crude oil contamination but in negligible concentration. 4% of crude oil (100ml) relative to the total mass of the mixture was added to each of the soil samples. The cow dung and bone char was sun-dried for the duration of 2 weeks and thereafter grounded using a mortar, pestle and a manual grinding machine. Thereafter they were sieved using a 2mm standard mesh sieve and were measured with an electronic weighing balance. The following are the design pattern for the ex-situ bioremediation procedure (1) Each sample design consists of 4% crude oil

contamination and 2000g of soil (2) The amendments (nutrients) differ according to the proportional optimization rates. The amendments were added to the sample designs except for the control (3) the individual

cells were moistened and mixed with a stirrer these stirring were conducted on an interval of four days for effective aeration.

Table 1: The design pattern for cow dung and cow bone char used as amendments in each sample

Control	2000g of soil + 100 ml of crude oil + 0g of cow dung + 0g cow bone char
S1	2000g of soil + 100 ml of crude oil + 37.5g of cow dung+ 0g cow bone char
S2	2000g of soil + 100 ml of crude oil + 75g of cow dung + 0g cow bone char
S3	2000g of soil + 100 ml of crude oil + 0g of cow dung+ 37.5g cow bone char
S4	2000g of soil+ 100 ml of crude oil+ 37.5g of cow dung + 37.5g cow bone char
S5	2000g of soil+ 100 ml of crude oil + 75g of cow dung+ 37.5g cow bone char
S6	2000g of soil+ 100 ml of crude oil + 0g of cow dung+ 75g cow bone char
S7	2000g of soil+ 100 ml of crude oil + 37.5g of cow dung+ 75g cow bone char
S8	2000g of soil+ 100 ml of crude oil + 75g of cow dung+ 75g cow bone char

c) Optimization using the design of the experiment

The three-level design is written as a 3^k factorial design. It means that k factors are considered and each at 3 levels. These are referred to as low, intermediate and high levels. These levels are numerically expressed

as 0, 1, and 2. This is the simplest three-level design. It has two factors, each at three levels. The 9 treatment combinations for this type of design can be shown as follows:

Table 2: Optimization rates for the bio-stimulants for bioremediation of crude oil-polluted soil

Observation	Cow dung [%]	Bone char [%]	Levels
1	0	0	Low
2	25	0	
3	50	0	
4	0	25	Intermediate
5	25	25	
6	50	25	
7	0	50	High
8	25	50	
9	50	50	

The three-level designs were proposed to model possible curvature in the response function and to handle the case of nominal factors at 3 levels. The third level for a continuous factor facilitates the investigation of a quadratic relationship between the response and each of the factors.

d) Data analysis

Mathematical modeling was used to analyze the degradation data gotten from the experiment by applying the first-order kinetic model. Also, calculations on the bio-stimulation efficiency and percentage of degradation were conducted.

i. *Mathematical model*

$$\frac{\delta C}{\delta t} = -k_1 C \tag{1}$$

C = concentration of degraded compound at time t,
and k_1 = first-order rate constant

$$\frac{\delta C}{\delta t} = \frac{-0.6933}{t_{1/2}} C \tag{2}$$

$$\ln C_t = -k_1 t + \ln C_o \tag{3}$$

$$t_{1/2} = \frac{0.6933}{k_1} = \frac{\ln 2}{k_1} \tag{4}$$

Where $t_{1/2}$ is the half-life

However, Eq. 3 can also be written as follows,

$$C_t = C_o \exp(-k_1 t) \tag{5}$$

However, the fractional efficiency of bio-degradation can be expressed as,

$$\frac{C_o - C_t}{C_o} = F.E \tag{6}$$

Which can be written as,

$$C_t = C_o (1 - F.E) \tag{7}$$

Thus, substituting Eq. 7 into Eq 5 one obtains,

$$t = -\frac{1}{k_1} \ln(1 - F.E) \tag{8}$$

which can be re-written as:

$$\ln\left(\frac{1}{1 - F.E}\right) = k_1 t \tag{9}$$

The percentage degradation (%) was calculated using the formula:

$$\% \text{ Degradation} = \frac{\text{THC}_o - \text{THC}_i}{\text{THC}_o} \tag{10}$$

where, THC_o = Initial THC concentration and THC_i = Residual THC concentration

ii. *Bio-stimulation efficiency*

The effectiveness of any remediation is controlled by some factors which are biotic and a biotic. It is certain that no remediation exercise can attain complete remediation, but rather the mitigation level

could be high to encourage the thriving of life. The efficiency of bio-stimulation (B.E) gives insight into the treatability options offered by the various proportional optimization rates of the bio-stimulants.

$$B.E = \frac{\% \text{THC}_T - \% \text{THC}_U}{\% \text{THC}_T} \tag{11}$$

where $\% \text{THC}_T$ = percentage removal of crude oil in the bio-stimulated or amended soil, and $\% \text{THC}_U$ = The percentage removal of crude oil in the non-bio-stimulated soil.

soil was observed for a period of 6 weeks. The results were tabulated and illustrated in graphical patterns which shows the remediation process been carried out. These graphical representations give various insights into the optimization process.

III. RESULTS AND DISCUSSION

The analysis of the proportional optimization of amendments for bio-remediating the crude oil polluted

The amendments used are cow dung and bone char. The following is the proportional optimization of the amendments.

Table 3: A table showing the optimization rates and mass of amendments of the samples

Sample	Optimization rate	Mass of biomass
1	0% Cow Dung 0% Bone Char	Cow Dung = 0g; Bone Char = 0g
2	0% Cow Dung 25% Bone Char	Cow Dung = 37.5g; Bone Char = 0g
3	0% Cow Dung 50% Bone Char	Cow Dung = 75.0g; Bone Char = 0g
4	25% Cow Dung 0% Bone Char	Cow Dung = 0g; Bone Char = 37.5g
5	25% Cow Dung 25% Bone Char	Cow Dung = 37.5g; Bone Char = 37.5g
6	25% Cow Dung 50% Bone Char	Cow Dung = 75.0g; Bone Char = 37.5g
7	50% Cow Dung 0% Bone Char	Cow Dung = 0g; Bone Char = 75.0g
8	50% Cow Dung 25% Bone Char	Cow Dung = 37.5g; Bone Char = 75.0g
9	50% Cow Dung 50% Bone Char	Cow Dung = 75.0g; Bone Char = 75.0g

a) *Physiochemical analysis of cow dung and bone char* matter %, Nitrogen %, and Phosphorus contents as shown below:
 The physicochemical analysis was gotten from the amendments stating the carbon %, ash content %, volatile

Table 4: Result showing the Physiochemical Analysis of Cow dung and Bone Char

Sample Identity	% Carbon	% Ash content	Volatile Matter	Phosphorus (mg/kg)	% Nitrogen	C/P ratio	C/N ratio
Cow Dung	2.91	79.4	20.6	1.304	0.045	2.231595	64.66667
Bone Char	2.4	60.7	39.3	1.712	0.007	1.401869	342.8571

Table 5: Analysis of THC

Sample Identity	Week 1 THC (Mg/Kg)	Week 2 THC (Mg/Kg)	Week 3 THC (Mg/Kg)	Week 4 THC (Mg/Kg)	Week 5 THC (Mg/Kg)	Week 6 THC (Mg/Kg)
Control 0%CD 0% BC	7500	5850	5750	4450	4000	3400
0%CD 25% BC	7350	4500	3750	3300	2850	2250
0%CD 50% BC	4500	3000	2850	2700	2250	1800
25% CD 0% BC	7200	3600	3300	3000	2700	1650
25%CD 25% BC	4500	3900	3150	2400	2100	1200
25%CD 50% BC	4500	4350	3000	2550	2250	1350
50%CD 0% BC	4650	3300	2700	2250	1800	1200
50%CD 25% BC	6000	3750	2850	2325	1875	1650
50%CD 50% BC	7500	3300	2700	2400	1950	1650

CD= Cow Dung
 BC= Bone Char

b) *Statistical analysis of THC*

The biodegradation of THC in the soil of 4% crude oil contamination was analyzed for the various optimization rates using the statistical t-test by the following conditional statements below: If $P > 0.05$ we should accept the null hypothesis (H_0); of no significant effect on remediation process and reject the alternative hypothesis (H_i); of a significant effect on remediation.

If $P < 0.05$ we reject the null hypothesis (H_0); of no significant effect on the remediation process and we accept the alternative hypothesis (H_i); of a significant effect on the remediation process. From the data gathered, the table shows the various P-value and remarks of the sample.

Table 7: Summary of t-test table for THC degradation

Samples	Rate	Mass	P-Value	Remark
1	Control	CD=0g; BC=0g	-	-
2	0%CD 25% BC	CD=37.5g;BC=0g	4.97 E-03	Significant Difference

3	0%CD 50% BC	CD=75.0g; BC=0g	3.84E-04	Significant Difference
4	25% CD 0% BC	CD=0g; BC=37.5g	3.99E-03	Significant Difference
5	25%CD 25% BC	CD=37.5g; BC=37.5g	4.90E-05	Significant Difference
6	25%CD 50% BC	CD=75.0g; BC=37.5g	2.87E-04	Significant Difference
7	50%CD 0% BC	CD=0g; BC=75.0g	1.51E-05	Significant Difference
8	50%CD 25% BC	CD=37.5g; BC=75.0g	1.20E-04	Significant Difference
9	50%CD 50% BC	CD=75.0g; BC=75.0g	6.46E-03	Significant Difference

CD = Cow dung; BC = Bone Char

Further analysis of the various proportional optimization rates for bioremediation was also ascertained using the student's t-test. From the student's t-test results shown, a significant level ($P < 0.05$) was observed for treatment using the various optimization rates of amendments in Samples 2, 3, 4, 5, 6, 7, 8, 9 as compared with control (Sample 1). Thus, there was a significant difference in all the samples. So, we accept the alternative hypothesis (H_1); which indicates a significant reduction in crude oil

contamination for the various optimization rates of amendments in the samples.

c) *Percentage of Degradation*

The percentage degradation for the various sample blocks is shown in the bar chart below. From the chart, it can be deduced that sample 9 has the greatest degradation of Total hydrocarbon Content (THC). Thus, in all samples the percentage of degradation was above 50%, showing effective bioremediation.

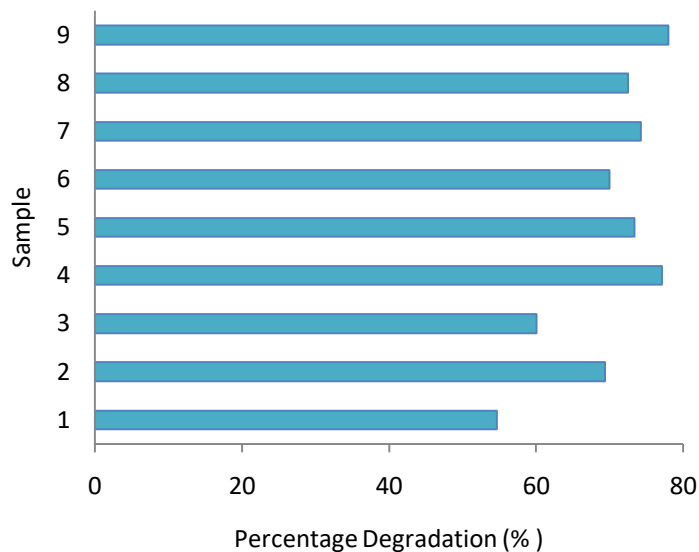

Figure 1: Bar Chart Showing the Percentage Degradation of the Nine (9) Samples

$$\% \text{degradation} = 75.30540 + 0.34274 \times \text{CD} + 6.77319 \times \text{BC} - 2.74977 \times \text{CD}^2 - 5.34756 \times \text{BC}^2 - 0.38172 \times \text{CD} \times \text{BC}$$

where BC = Bone char rate [%]; CD = Cow dung rate [%]

d) *Optimal mix of cow dung and bone char using response surface methodology (RSM)*

Response surface methodology (RSM) is a collection of statistical and mathematical techniques for building an empirical model. The objective is to optimize a response (output variable) which is influenced by several independent variables (input variables i.e. cow dung and bone char rates).

Using the response surface methodology (RSM), the optimal THC degradation Efficiency is

between 76.50 – 80.00%. The optimal mix of the cow dung is between 20 – 38% and the bone char is 35 - 50%.

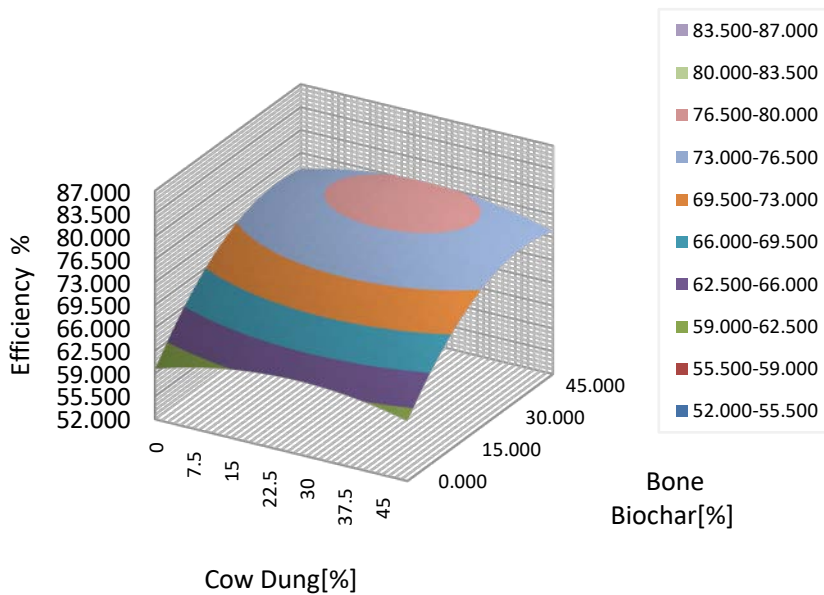

Figure 2: Contour plot (3D view) showing the THC degradation efficiency of the Bio-Stimulants in the amended soil

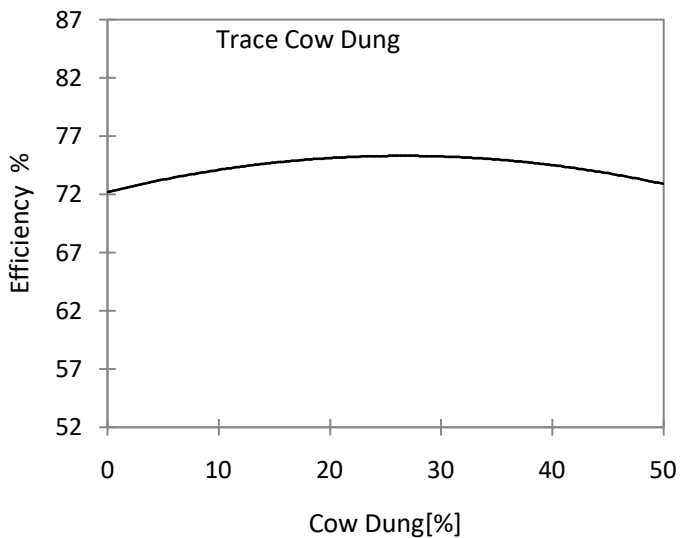

Figure 3: A plot of Efficiency at various optimization rates of Cow Dung

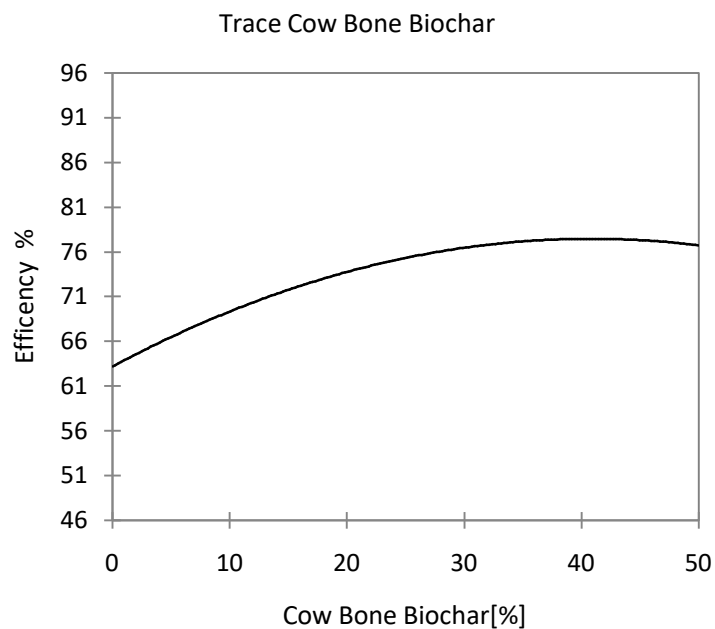

Figure 4: A plot of Efficiency at various optimization rates of Bio char

Table 8: Experimental design table for various samples observation

Sort Order	Run Order	Repetition	Cow Dung	Cow Bone Biochar	% Degradation
1	1	1	0	0	54.67
2	2	1	25	0	69.39
3	3	1	50	0	60
4	4	1	0	25	77.08
5	5	1	25	25	73.33
6	6	1	50	25	70
7	7	1	0	50	74.19
8	8	1	25	50	72.5
9	9	1	50	50	78



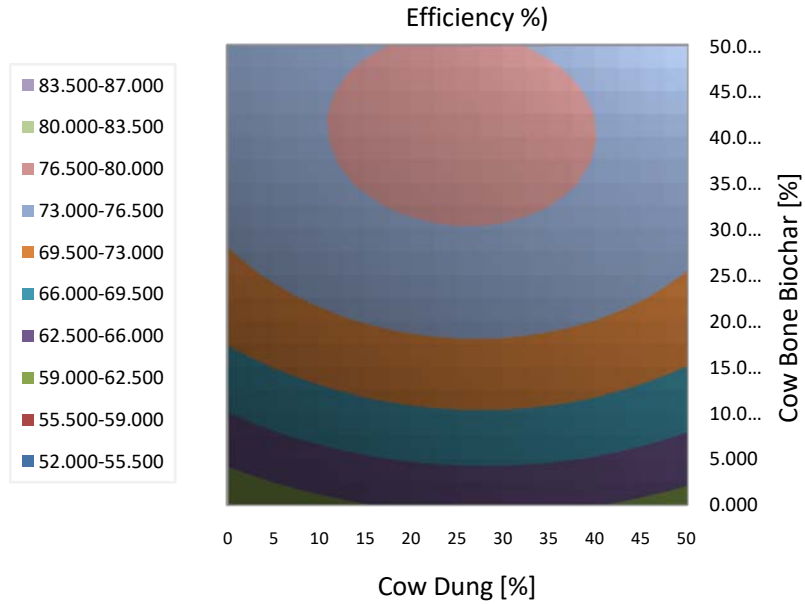
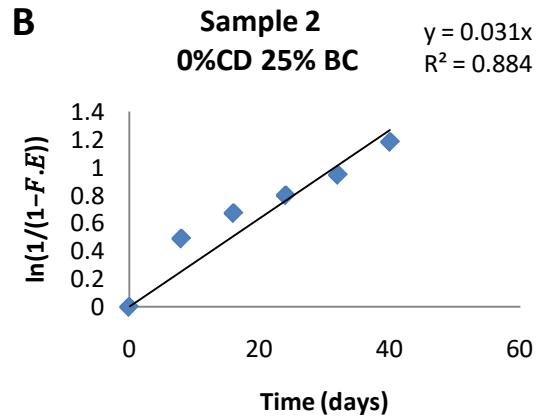
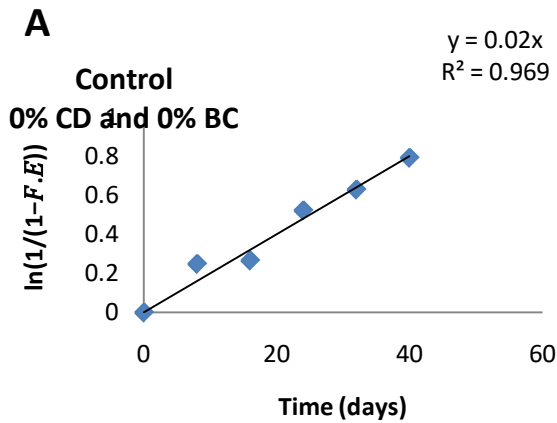

Figure 5: A Contour plot showing the Efficiency from the various optimization rates of the Bio-Stimulants.

e) Kinetics of total hydrocarbon (THC) degradation

The kinetics of THC degradation was studied using first-order kinetics, which proposes that the rate of change of substrate is directly proportional to the

concentration of the substrate. High K value implies high degradation rate. The fractional efficiency was plotted against time for each of the samples.



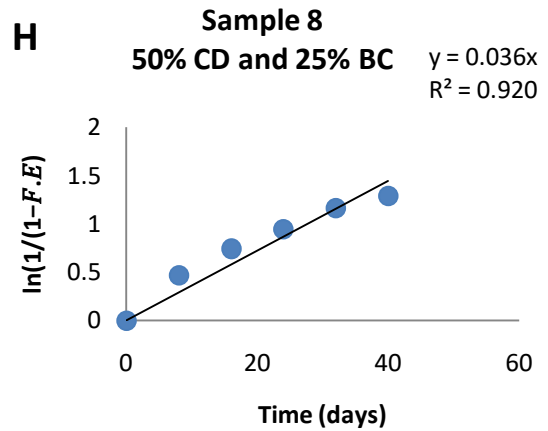
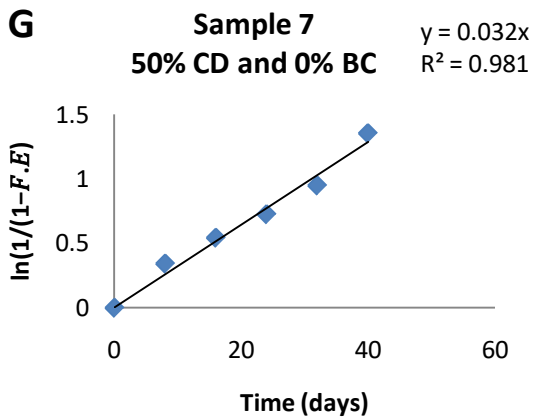
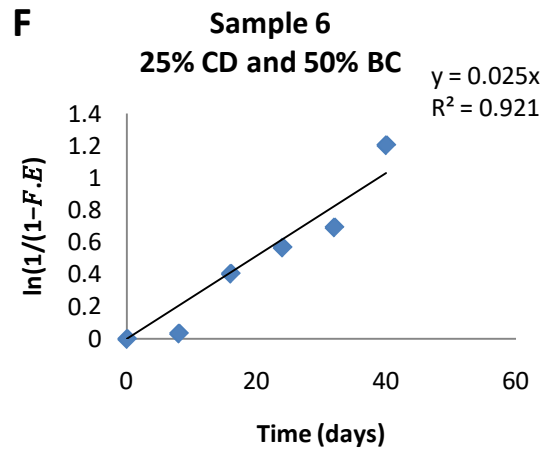
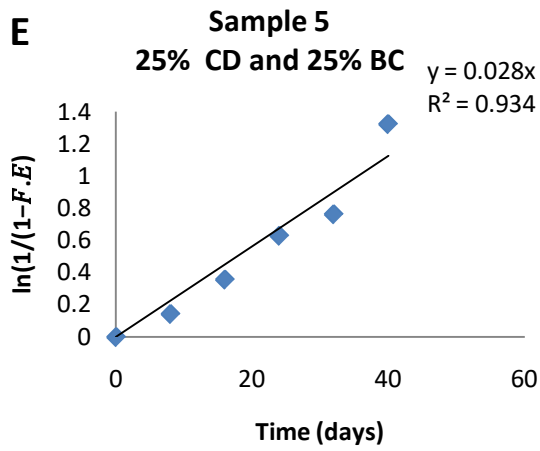
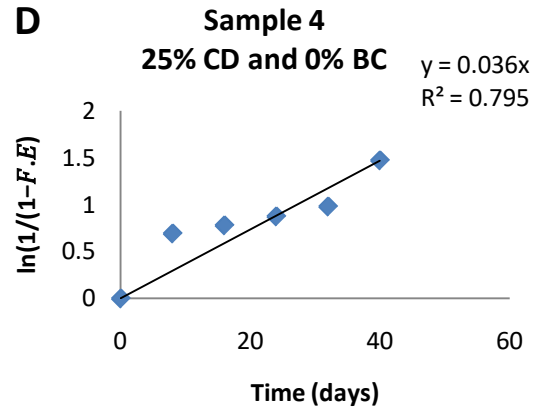
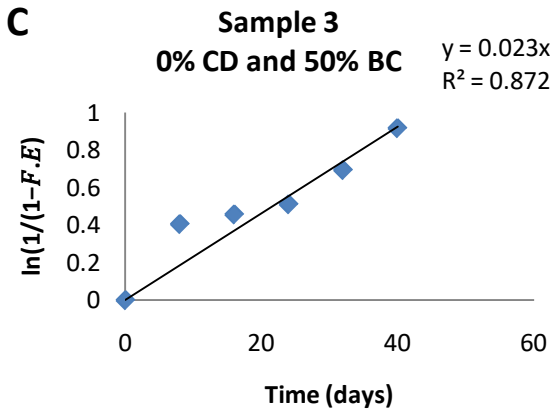

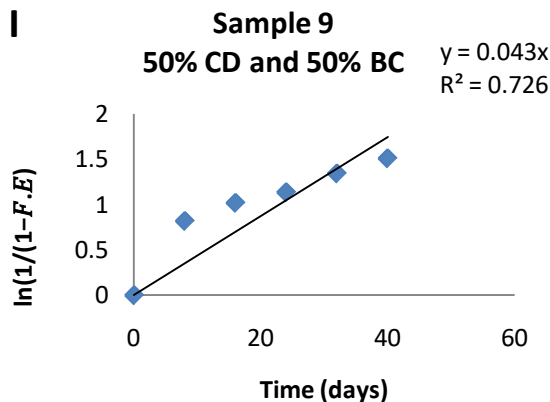

Figure 6: (A) First Order Kinetic pattern of THC reduction for Control (B) Sample 2 (C) Sample 3 (D) Sample 4 (E) Sample 5 (F) Sample 6 (G) Sample 7 (H) Sample 8 (I) Sample 9

From the above graphs in figure 6, it was observed that the coefficient of determination (R^2) indicates a positive correlation for the reduction in Total Hydrocarbon Content (THC) with respect to time with a biodegradation rate constant of 0.02Day^{-1} , 0.031Day^{-1} , 0.023Day^{-1} , 0.036Day^{-1} , 0.028Day^{-1} , 0.025Day^{-1} , 0.032Day^{-1} , 0.036Day^{-1} and 0.043Day^{-1} for the Samples 1-9. The biodegradation rate constant differs for each of the samples, it can be noted that the higher the rate constant the smaller the half-life in the sample. Sample 9 has the highest biodegradation rate constant of 0.043Day^{-1} and a half-life of 16 days followed by sample 8 with a rate constant of 0.036Day^{-1} and a half-life of 19 days, Followed by sample 4 with a rate

constant of 0.036Day^{-1} and a half-life of 19 days, followed by sample 7 with a rate constant of 0.032Day^{-1} and a half-life of 22 days, followed by sample 2 with a rate constant of 0.031Day^{-1} and a half-life of 22 days, followed by sample 5 with a rate constant of 0.028Day^{-1} and a half-life of 25 days, followed by sample 6 with a rate constant of 0.025Day^{-1} and a half-life of 28 days, followed by sample 3 with a rate constant of 0.023Day^{-1} and a half-life of 30 days, followed by control with a rate constant of 0.02Day^{-1} and a half life of 35 days. The remediation rate in descending order for hydrocarbon degradation is given as: Sample 9 > sample 8 > sample 4 > sample 7 > sample 2 > sample 5 > sample 6 > sample 3 > control.

Table 9: First order decay equation, biodegradation rate constant, half-life

Samples	Rate	Mass	Kinetics Equation	K (day^{-1})	Half-Life $t_{1/2}$ (days)	R^2	% D	B.E (%)
1	Control	CD=0g; BC=0g	$y = 0.02x$	0.02	35	0.969	54.67	
2	0%CD 25%CBC	CD=37.5g; BC=0g	$y = 0.031x$	0.031	22	0.884	69.39	21.21
3	0%CD 50%CBC	CD=75.0g; BC=0g	$y = 0.023x$	0.023	30	0.872	60	8.89
4	25% CD 0%CBC	CD=0g; BC=37.5g	$y = 0.036x$	0.036	19	0.795	77.08	29.08
5	25%CD 25%CBC	CD=37.5g; BC=37.5g	$y = 0.028x$	0.028	25	0.934	73.33	25.45
6	25%CD 50%CBC	CD=75.0g; BC=37.5g	$y = 0.025x$	0.025	28	0.921	70	21.90
7	50%CD 0%CBC	CD=0g; BC=75.0g	$y = 0.032x$	0.032	22	0.981	74.19	26.32
8	50%CD 25%CBC	CD=37.5g; BC=75.0g	$y = 0.036x$	0.036	19	0.92	72.5	24.60
9	50%CD 50%CBC	CD=75.0g; BC=75.0g	$y = 0.043x$	0.043	16	0.726	78	29.91

CD = Cow dung; BC = Bone Char; % D = Percentage degradation; B.E = Bio-stimulation efficiency; R^2 = Correlation coefficient.

IV. CONCLUSION

The percentage degradation for the various sample blocks shows that sample 9 has the greatest degradation of Total hydrocarbon Content (THC). Also, in all samples the percentage of degradation was above 50%, showing effective bioremediation. Using the response surface methodology (RSM), the optimal THC degradation Efficiency is between 76.50 – 80.00%. The optimal mix proportion for cow dung is between 20 – 38% and for bone char, it is between 35 -50%. In terms of mass, the proportional optimal mix for the cow dung is between 30 – 57g and bone char is 52.5 – 75g for every 2kg of soil with a 4% crude oil contamination relative to the total mass of the mixture.

REFERENCES RÉFÉRENCES REFERENCIAS

1. Agarry S. E., Kigho M. O., Bamidele O. S. (2005) Kinetic modeling and half-life study of adsorptive bioremediation of soil artificially contaminated with bonny light crude oil, *Journal of Ecological Engineering* Volume 16, Issue 3, pp 1–13
2. Alexander M (1994). "Biodegradation and Bioremediation" .Publishers Academic Press, Inc. California, USA, pp. xi.
3. Al-Sulaimani, Y., Al-Wahaibi, S. and Al-Bahry et al. (2010). "Experimental investigation of bio surfactants produced by Bacillus species and their potential for MEOR in an Omani oil field," *Proceedings of the SPE EOR Conference at Oil and Gas West Asia 2010 (OGWA '10)*, pp. 378-386,
4. Annunciado, T., Syden stricker T. and Amico, S. (2005). Experimental investigation of various vegetable fibers as sorbent materials for oil spills. *Marine Pollution Bulletin*, 50: pp 1340-1346.
5. Davis, D. and Guidry R., (1996). Oil spills and the state responsibilities, *Basin Research Institute Bulletin*, 6: pp 60-68.
6. Eckenfelder, W. and Norris R., (1993). Applicability of Biological Process for Treatment of Soils. In: *Emerging Technologies in Hazardous Waste Management*, Tedder, D. W. and F. G. Pohland (Eds.). American Chemical Society, Washington, D. C., pp: 138-158.
7. Elektorowicz M (1994) Bioremediation of petroleum-contaminated clayey soil with pretreatment. *Environ Technol*15: 373-380.
8. Environmental Protection Agency (EPA), 1994. Land farming. How to evaluate alternative cleanup technologies for underground storage tank sites: A Guide for Corrective Action Plan Review
9. Gradi, P.C (1985) Biodegradation. Its Management and Microbiology Basis. *Biotechnology and Bioengineering* 27: pp 660-674.
10. Killham, K. (1994). *Soil Ecology*. Cambridge University Press. The U. K.
11. Kumar, A. Bisht, B., Joshi, V. and Dhewa, T. (2011). Review of Bioremediation of Polluted Environment: A management tool. *International Journal of Environmental Sciences* Vol. 1.
12. Leahy, J., Colwell, R. (1990) Microbial Degradation of hydrocarbons in the environment. *Microbial Reviews*, 53(3), pp305-315.
13. Leung M, Bioremediation: techniques for cleaning up a mess, *Journal of Biotechnology*, vol. 2, pp. 18-22, 2004.
14. Odu, C. (1978); the effects of nutrients application and aeration on oil degradation in soil. *Environmental Pollution* 15: pp 235-240
15. Ofoegbu R, Momoh Y, Nwaogazie I. (2014) Bioremediation of Crude Oil Contaminated Soil Using Organic and Inorganic Fertilizers. *J Pet Environ Biotechnol* 6: pp 198.



This page is intentionally left blank



GLOBAL JOURNAL OF RESEARCHES IN ENGINEERING: J
GENERAL ENGINEERING
Volume 19 Issue 5 Version 1.0 Year 2019
Type: Double Blind Peer Reviewed International Research Journal
Publisher: Global Journals
Online ISSN: 2249-4596 & Print ISSN: 0975-5861

Design, Construction and Performance Test of an Automatic Fire Fighting System

By Bashar, Khayrul, Islam Nazmul & Abdullah Al Saeed

Northern University Bangladesh

Abstract- Securing the modern lifestyle and embedding with the amenity and composure requires intelligent safety systems, that will be cognizant enough to sense and act on the anomaly of ambiance. Fire, undoubtedly, holds the most life-threatening risk when dispersing in an uncontrolled manner. This work represents the design and test of an intelligent fire control system for securing building or home, also fire control linkage system design, at the same time, it describes the following: the idea of the system designing, the system components, selecting equipment, the linkage of sensor and water extinguishing. This system uses different types of sensors and micro controlling devices that use the reservoir tank, pump, and piping system to deliver water and alarm systems to alert people. The result was taken at different temperatures, smoke levels, and flame existence levels. This will inspire the designing of intelligent systems with little investments and humanoid firefighters capable of extinguishing large fires.

Keywords: firefighting system, temperature sensor, flame sensor, smoke sensor, micro controlling, pump, pipeline, sprinkler, high temperature, smoke density, reservoir tank, alarm system.

GJRE-J Classification: FOR Code: 091599



Strictly as per the compliance and regulations of:



© 2019. Bashar, Khayrul, Islam Nazmul & Abdullah Al Saeed. This is a research/review paper, distributed under the terms of the Creative Commons Attribution-Noncommercial 3.0 Unported License (<http://creativecommons.org/licenses/by-nc/3.0/>), permitting all non commercial use, distribution, and reproduction in any medium, provided the original work is properly cited.

Design, Construction and Performance Test of an Automatic Fire Fighting System

Bashar, Khayrul^α Nazmul Islam^σ & Abdullah Al Saeed^ρ

Abstract- Securing the modern lifestyle and embedding with the amenity and composure requires intelligent safety systems, that will be cognizant enough to sense and act on the anomaly of ambiance. Fire, undoubtedly, holds the most life-threatening risk when dispersing in an uncontrolled manner. This work represents the design and test of an intelligent fire control system for securing building or home, also fire control linkage system design, at the same time, it describes the following: the idea of the system designing, the system components, selecting equipment, the linkage of sensor and water extinguishing. This system uses different types of sensors and micro controlling devices that use the reservoir tank, pump, and piping system to deliver water and alarm systems to alert people. The result was taken at different temperatures, smoke levels, and flame existence levels. This will inspire the designing of intelligent systems with little investments and humanoid firefighters capable of extinguishing large fires.

Keywords: firefighting system, temperature sensor, flame sensor, smoke sensor, micro controlling, pump, pipeline, sprinkler, high temperature, smoke density, reservoir tank, alarm system.

I. INTRODUCTION

The responsibility of preserving and protecting an institution's collections, buildings occupants and operations requires certain attention to minimize adverse impact due to climate, pollution, theft, insects, and fire. Because of the speed of the destroying forces of fire, it is one of the most serious threats. Automatic fire control systems extinguish fires without human intervention. Some examples of automatic systems include fire sprinkler system and gaseous fire suppression. When fires are extinguished in the early stages, loss of life is minimal since 93% of all fire-related deaths occur once the fire has progressed beyond the early stages. [1] With this information, the role and interaction of these supplemental fire safety systems in the protection process can then be better realized.

The heat from oxidation raises the temperature of surrounding materials, which increases the rate of oxidation and begins a chemical chain reaction of heat release and burning. A fire can progress from the smoldering phase immediately or slowly, depending upon the fuel, nearby combustibles, and the availability of oxygen in the surrounding air. [2]

In the modern era, fire departments constitute a comparatively recent development. Their personnel are

either volunteer (no salaried) or career (salaried). There is a different type of firefighter like volunteer firefighters are found mainly in smaller communities, career firefighters in cities. The modern department with salaried personnel and standardized equipment became an integral part of municipal administration only late in the 19th century. [3]

This model presents an overview of fire detection, alarm and sprinkler systems including system types, components, and operations. The smoke sensor is highly sensitive and gas flammable and has the ability to quick-fire detection. It has a long life and low cost and compatible with the Arduino Uno board based on ATMEGE328 microcontroller. Smoke alarm attached with a detector can warn people when they are sleeping or busy or in a different part of the house but when they are not at home automatic controlling systems will control the fire.

II. LITERATURE REVIEW

Different methods exist to provide estimates of smoke detector response based on optical density, gas velocity thresholds, and temperature rise. The objective of those types of the study was to assess the uncertainty associated with these estimation methods. Experimental data were used to evaluate recommended alarm thresholds and to quantify the associated error. [4] According to the survey, 96-97% of US households have at least one smoke alarm, yet in 2007-2011, smoke alarms were present in only three-quarters (73%) of all reported home fires and operated in half (52%) of all reported home fires. ("Homes" include one- and two-family homes, apartments, and manufactured housing.) More than one-third (37%) of all home fire deaths resulted from fires in homes with no smoke alarms, while almost one-quarter (23%) resulted from fires in homes in which smoke alarms were present but did not operate. These lists are based on data from the U.S. Fire Administration's (USFA's) National Fire Incident Reporting System (NFIRS) and the National Fire Protection Association's (NFPA's). [6] New advanced fire suppression systems in recent years. Some of the newly developed fire controlling systems include halocarbon and inert gaseous agents, compressed air foam systems, and aerosol, water mist systems and gas generators. This paper describes the newly developed fire controlling systems and provides pragmatic information on the fire suppression performance of each

Author α σ ρ : Lecturer, Northern University Bangladesh, Ashkona, Uttara, Dhaka-1230, Bangladesh. e-mail: nazmulbutex38@gmail.com

system as well as the limitations or concerns related to using the new suppression systems. [7] The automatic fire alarm system provides real-time surveillance, monitoring, and automatic alarm. The early alarm sends when the fire occurs and helps to reduce the fire damage. Nowadays, wireless sensor network has become the most important technology in environmental monitoring and home or factory automation in recent years. An automatic fire alarm system based on wireless sensor networks is developed, which is designed for high-rise buildings are discussed in this paper. [8] A method of monitoring the condition of the battery of a smoke or heat alarm so as to provide a warning of an impending low battery condition, the said condition being that of a battery which has depleted to an energy level at and below which it is recommended that the battery be replaced to maintain the full 'functionality of the alarm device. [9] An apparatus for and method of detecting fires comprising detecting (With one or more detectors) levels of carbon monoxide, carbon dioxide, and smoke in an ambient environment, computing (using a processor) overtime rates of increase of each of the levels' and generating an alarm if one or more of the rates of increase exceeds predetermined threshold rates of increase. [10] An upright fire protection sprinkler having an input orifice at an input end of the sprinkler for receiving fluid and an output orifice at an output end of the sprinkler for outputting fluid. The sprinkler has a connection portion at the input end of the sprinkler and a body extending between the connection portion and the output end. A pair of frame arms extends from the output end and meets at a hub positioned in axial alignment with the output orifice. A detector is positioned on the hub and is configured to direct fluid output from the output orifice substantially in a direction back toward the output end. [11] Analyze the safety of the process. Multistate of the fire protection system is mainly expressed in the unit versatility and impact of external interference signals. Moreover, in a fire system, water supply system, power supply system, and an automatic alarm system achieve operation of the system

through triggering and flowing of water signal and current signal. [12]

X. Liao et al. [13] have provided an automatic fire extinguishing strategy with real-time monitoring, exploration and programmed fire alarm. The paper proposed an algorithm that sends an early alarm when the fire occurs. This system consists of a smoke detector and a temperature sensor whose outputs are connected to the control. The paper demonstrated their results by showing temperature and area in table format. The cost was calculated in Bangladesh Taka (BDT) currency.

A. ŁEBKOWSKI [14] has proposed a system which comprises a smoke detector and a temperature sensor and outputs are controlled by a controller. The density of smoke takes into account and thus the probability of false alarms can be avoided. It consists of ATMEGA328, Ultrasonic sensor, Gas sensor, IR module, Motor, Water pump, Servo motor, Power supply. Flame and gas intensity were detected by the IR Sensor and gas sensor respectively and the signal was given to the ATMEGA328. If the flame is detected, the robot starts moving towards the flame. It is done by a motor. After detecting the location of the flame, the robot comes close to the location and the pump is turned ON till the flame is extinguished. A. Ahmed et al. [15] have developed a system with main purpose of controlling fires by using a sprinkler system. The system consists of smoke and temperature sensor which send a signal to the microcontroller. If temperature and smoke cross the safety level, a buzzer will be buzzing and spraying water by using pump via the sprinkler system. The paper showed prototype design for a home also. Justin Aaron Geiman et al. [4] has provided a self-control smart sprinkler system. Multiple sensors have controlled through microcontroller unit. A flame sensor detects the intensity of the flame. The paper proposed solenoid valve has been opened when flame intensity crossed the danger level and water passes through an open sprinkler. Some mathematical calculation has shown for pressure intensity of water.

III. SYSTEM MODEL

a) Block Diagram

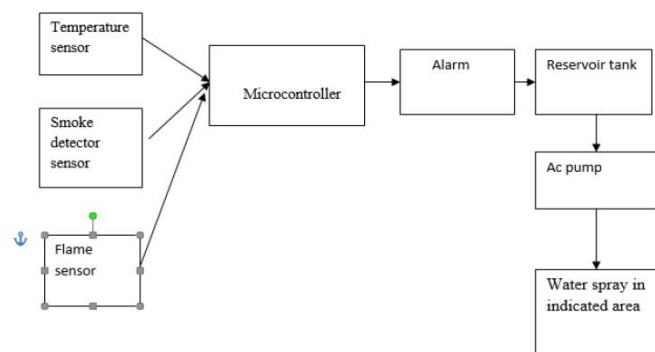

Figure 1: Block diagram for automatic fire controlling system

Fig. 1 shows the block diagram of three sensors such as a temperature sensor, a smoke sensor and a flame sensor which are connected with the microcontroller system. When the system will be on the buzzer is automatically buzzing and water will be spraying in the indicated area by using ac pump.

b) Schematic

microcontroller system. When the system will be on the buzzer is automatically buzzing and water will be spraying in the indicated area by using ac pump.

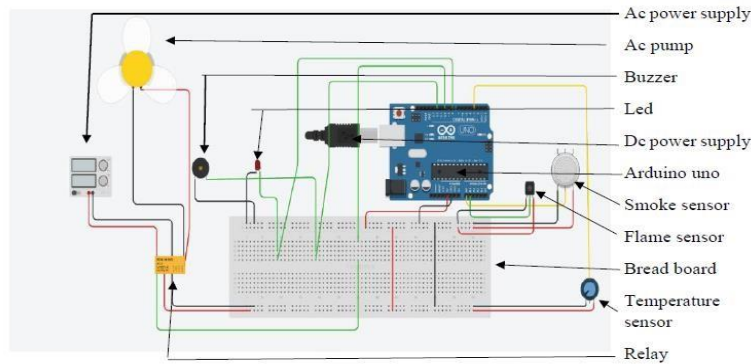

Figure 2: Circuit Diagram

In this circuit diagram (Fig. 2) Arduino Uno was used as a micro-controller platform. The smoke sensor MQ2 was attached with pin A0, the flame sensor was connected pin A1, the temperature sensor was attached at digital pin 3. Buzzer and LED was attached 12 and 8 pins respectively. The relay was attached by a pin 10. Dc and Ac power supply was provided for the total electrical system and ac pump respectively.

c) Construction

From Fig. 3 it can be shown that Reservoir tank dimension is:

- Length = 0.43m
- Width = 0.20 m
- Height = 0.15 m

So that, its volume is $(0.43 \times 0.20 \times 0.15) = 0.0135$ 3. It contains 13-liter water.

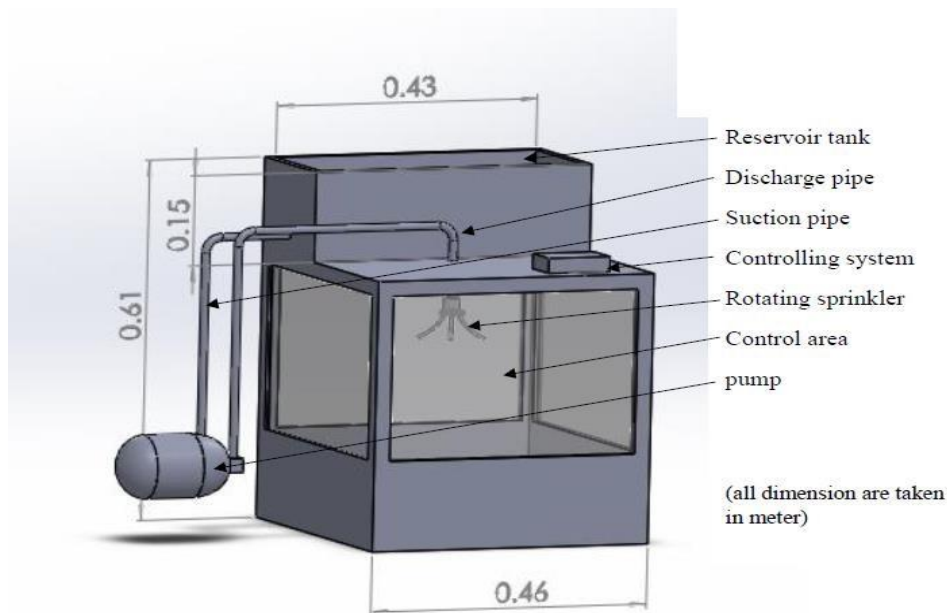

Figure 3: Isometric view of designed automatic fire controlling system



Figure 4: Actual Model

Fig. 4 shows the real view of the project after construction.

d) Micro controller programming

Microcontroller programming for Arduino uno was done by using software Arduino 1.8.1. Software programming are given below.

```
#include <dht.h>
#define DHT11_PIN 3
// lowest and highest sensor readings:
const int sensorMin = 0; // sensor minimum
const int sensorMax = 1024; // sensor maximum
int pump = 10;
int buzzer = 12;
int led = 8;
dht DHT;
const int gasPin = A0;
void setup ()
{
  pinMode (pump, OUTPUT);
  pinMode (buzzer, OUTPUT);
  pinMode (led, OUTPUT);
  Serial.begin (9600);
  Serial.println ("Fire safety: Bashar, Nazmul");
}
void loop ()
{
  // read the sensor on analog A0:
  int flameReading = analogRead (A1);
  int gasReading = analogRead (gasPin);
  int temp = DHT.temperature;
  int chk = DHT.read11(DHT11_PIN);
```

```
int range = map (flameReading, sensorMin, sensorMax,
0, 3);
//range value:
switch (range)
{
case 0: //A fire is closer than 1.5ft
Serial.println ("**Close Fire **");
break;
case 2: // No fire detected.
Serial.println ("No Fire");
break;
}
if (temp > 42 || range == 0 || gasReading > 300)
{
Serial.println (" I am ON");
digitalWrite (pump, HIGH);
digitalWrite (buzzer, HIGH);
digitalWrite (led, HIGH);
}
else
{
digitalWrite (pump, LOW);
digitalWrite (buzzer, LOW);
digitalWrite (led, LOW);
}
Serial.print ("Gas reading: ");
Serial.println (gasReading);
// Serial.print (" Humidity ");
// Serial.println (DHT.humidity, 1);
Serial.print ("Temperature ");
Serial.println (DHT.Temperature);
delay (1500);
//delay (1000);
}
```

In above, the Arduino Code has been shown that was used for this project. The codes were perfectly operated by the user and the output has been given in the result section.

IV. LOWCHART OF THE WHOLE PROCESS

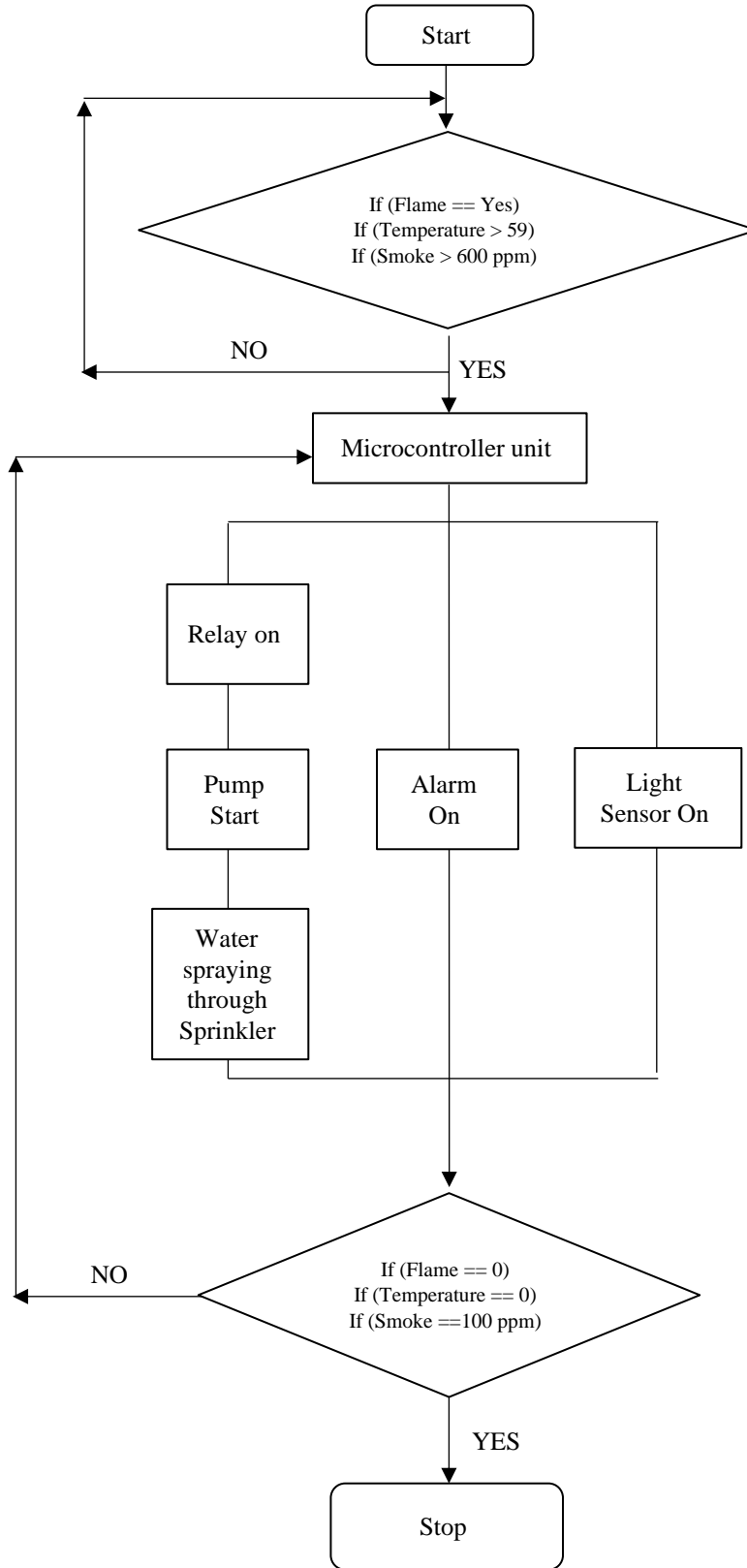

Figure 5: Flowchart



V. RESULTS AND DISCUSSION

a) Result

The performance of a fire fighting system greatly depends on the sensing capability of the smoke, temperature and flame sensor. When microcontroller gets signal alarm will operate otherwise it will wait for 1s. Microcontroller produced a satisfactory result which was shown in Table I, Table II and Table III.

Temperature Sensor Verification has been shown in table 1. In this method, it is designed to verify different temperature and if the temperature is more than our desire level then the pump will automatically on and the buzzer will be buzzing for different temperature such as 30, 40, 50 and 60 degree was considering individually. The different data table is given below in Table I.

Smoke Sensor Verification can be found by observing table 2. It is designed to verify different temperature and if the flame is more than our desire level then the pump will automatically on and the buzzer will make a sound for different temperature. Such as 300,400,500 and 600 ppm were considered individually. The data are given below in Table II. Flame Sensor Verification is shown in Table III. For verifying different temperature and if the flame is more than the desired level, the pump will automatically on and the buzzer will also make the sound for different temperature. If flame occurs within 0-1. 5 feet than it will "close fire" .If flame occurs in the range of 1. 5-3 feet, it will "distance fire" and rest there will no fire.

Table 1: Verification Test Data for Temperature using Temperature Sensor

Experiment no.	Temperature (degree)	Verified	Command Sent	Feedback
1.	0-59 degree	Yes	Not to start buzzer and pump, Green light on.	Responded
2.	60 or 60 plus degree	No	Start buzzer and pump, red light on till temperature below 30 degree.	Responded

Table 2: Verification Test Data for Smoke using Smoke Sensor

Experiment no.	Smoke (ppm)	Verified	Command Sent	Feedback
1.	0-559 ppm	Yes	Not to start buzzer and pump, Green light on.	Responded
2.	600 or 600 plus ppm	No	Start buzzer and pump, red light on till smoke level below 300 ppm.	Responded

Table 3: Verification Test Data for Flame using Sensor

Experiment no.	Flame distance (inch)	Command received	Verified	Command Sent	Feedback
1.	2-18 inch	Close fire	No	Start buzzer and pump, red light on.	Responded
2.	19-34 inch	Distance fire	Yes	Start buzzer, pump is off, yellow light on.	Responded
3.	34-infinity inch	No fire	Yes	Not to start buzzer and pump, Green light on.	Responded

b) Discussions

The total cost of project has been shown in Table IV.

Table 4: Estimated Cost

No.	Component Name	Number of equipment	Cost (BDT)
1.	Temperature sensor	2+2+2=6	200
	Smoke sensor		
	Flame sensor		
2.	Microcontroller (arduino uno)	1	500
3.	Pump (12.5 hp)	1	1200
4.	Relay	1	30
5.	led	3	4.5
6.	Ic regulator	1	12
7.	Resistance	5	5
8.	Capacitor	2	3
9.	Diode	1	1.5
10.	Bread board	1	100
11.	Sprinkler	1	200
12.	buzzer	2	40
13.	Pipe	3ft	50
total			2346 taka

From the above project the following results were found:

Temperature Sensor

1. Everything went good in performance test.
2. Different temperature was coded and it worked perfectly, sometimes made small error for high temperature.

Smoke Sensor

1. Everything went good in performance test.
2. Some disturbance was observed for power supply.

Flame Sensor

1. Everything went good in performance test.
2. Small error was observed for poor component

Some other component such as relay and ac pump, rotating sprinkler worked perfectly. There was a small leakage problem because pipe line was not perfectly constructed.

FUTURE PROSPECTS

Fire Eliminator Robot - A mobile robot with features like: -

1. Thermocouple detection system.
2. Water reservoir tank.
3. Fire extinguisher system.

Automatic SONIC FIRE EXTINGUISHERS SYSTEM

1. Using sound wave to control fire by automat
2. Design of a Fire Alarm App:
3. Contains "How to Prevent Fire" manual.
4. Uses GPS to send emergency message about fire.

1. Remotely controlled aerial camera
2. Detecting fire
3. Automatically taking an action

VI. CONCLUSION

Automatic fire controlling system has become a great issue in this modern era. Every section of apartment building, bank, office, restaurant, market, parking place, police station, hospital, industry each and every portion of building its necessary to control the fire. Every scope of daily life now wants a promising and smooth fire-fighting system for a building. It would be one step ahead advantage if we can control fire automatically.

Temperature sensor, smoke sensor, and the flame sensor will detect fire automatically and spraying water in controlling the area immediately so that fire cannot explode quickly and we control fire easily.

REFERENCES RÉFÉRENCES REFERENCIAS

1. 2018. [Online]. Available: <https://www.nedcc.org/free-resources/preservation/leaflets/3.emergencymanagement/3.2an-introduction-to-fire-detection-alarm-and-automatic-firesprinklers>. [Accessed: 14- Jun- 2018].
2. "iaff266.com - iaff266 Resources and Information.", iaff266.com, 2018. [Online]. Available: <http://iaff266.com/flashover>. [Accessed: 18- May- 2018].
3. 2016. [Online]. Available: <https://www.emergencydispatch.org/articles/historyoffirefighting.html>. [Accessed: 06- Apr- 2018].

4. Justin Aaron Geiman, "EVALUATION OF SMOKE DETECTOR RESPONSE ESTIMATION METHODS". University of Maryland, Master of Science 2003.
5. "Bangladesh Fire service", Fireservice.gov.bd, 2018. [Online]. Available: <http://www.fireservice.gov.bd/>. [Accessed: 02- Mar- 2018].
6. Marty Ahrens, "Smoke Alarms in U. S. Home Fires". National Fire Protection Association Fire Analysis and Research Division, March 2014.
7. M. A. Delichatsios, B. Z. Dlugogorski and E. M. Kennedy, "RECENT DEVELOPMENT IN FIRE SUPPRESSION SYSTEMS" .Proceedings, 5th AOSFST, Newcastle, Australia, 2001.
8. Lei Zhang, and Gaofeng Wang, "Design and Implementation of Automatic Fire Alarm System based on Wireless Sensor Networks". Proceedings of the 2009 International Symposium on Information Processing (ISIP'09).
9. Ilbert Alain Lindsay Garrick; Marie Cammeray Court, "FIRE DETECTOR SILENCEABLE LOW BATTERY PRE-ALARM". United States Patent, Patent Number: 6,081,197, Jun. 27, 2000.
10. Shin-Juh Chen, Santa Fe, "FIRE ALARM ALGORITHM USING SMOKE AND GAS SENSORS ". United States Patent, Patent No.: US 7,142,105 B2, Nov. 28, 2006.
11. Thomas L. Multer, Westm1nster, (Us), George Greer, SC (Us), "AUTOMATIC FIRE PROTECTION SPRINKLER WITH EXTENDED BODY". United States Patent, Patent No.: US 8,162,069 B2, Date of Patent: April. 24 2012.
12. Ling-ling XU, Chun-xiao LI, Hui-bin DU, "Building Fire Protection System Reliability Analysis Based on GO Method". Department of Management, Hebei Institute of Architecture and Civil Engineering, Zhangjiakou 075000, China.
13. X. Liao, H. Shan, Z. Quan and L. Peng, "The Design and Implementation of Automatic Fire Extinguishing and Explosion Suppression System's Testing Equipment", Applied Mechanics and Materials, vol. 543-547, pp. 1192-1196, 2014.
14. ŁEBKOWSKI, "Electric Vehicle Fire Extinguishing System", PRZEGLĄD ELEKTROTECHNICZNY, vol. 1, no. 1, pp. 331-334, 2017.
15. Ahmed, A. Mansor and A. Albagul, "Design and Fabrication of an Automatic Sprinkler Fire Fighting System", Design and Modeling of Mechanical Systems - II, pp. 41-49, 2015.



GLOBAL JOURNAL OF RESEARCHES IN ENGINEERING: J
GENERAL ENGINEERING
Volume 19 Issue 5 Version 1.0 Year 2019
Type: Double Blind Peer Reviewed International Research Journal
Publisher: Global Journals
Online ISSN: 2249-4596 & Print ISSN: 0975-5861

Use of the Split Hopkinson Pressure Bar on Performance Evaluation of Polymer Composites for Ballistic Protection Purposes

By Rafael Rodrigues Dias, Iaci Miranda Pereira & Bluma Guenther Soares

Northern University Bangladesh

Abstract- This article presents a review of the split Hopkinson pressure bar uses on evaluation of polymer composites ballistic material's dynamic mechanical properties. A small introduction concerning the equipment is given, followed by a summarization of the most recent published studies relating to dynamic compressive tests used to study dynamic properties of ballistic polymeric composites such as Young's modulus, maximum stress, strain at maximum stress, tenacity and maximum strain, as well as the sensitivity of these properties to changes in the applied strain rate.

Keywords: hopkinson bar, high strain rate, ballistic composites, failure mechanisms.

GJRE-J Classification: FOR Code: 091599



Strictly as per the compliance and regulations of:



© 2019. Rafael Rodrigues Dias, Iaci Miranda Pereira & Bluma Guenther Soares. This is a research/review paper, distributed under the terms of the Creative Commons Attribution-Noncommercial 3.0 Unported License (<http://creativecommons.org/licenses/by-nc/3.0/>), permitting all non commercial use, distribution, and reproduction in any medium, provided the original work is properly cited.

Use of the Split Hopkinson Pressure Bar on Performance Evaluation of Polymer Composites for Ballistic Protection Purposes

Rafael Rodrigues Dias ^α, Iaci Miranda Pereira ^ο & Bluma Guenther Soares ^ρ

Abstract- This article presents a review of the split Hopkinson pressure bar uses on evaluation of polymer composites ballistic material's dynamic mechanical properties. A small introduction concerning the equipment is given, followed by a summarization of the most recent published studies relating to dynamic compressive tests used to study dynamic properties of ballistic polymeric composites such as Young's modulus, maximum stress, strain at maximum stress, tenacity and maximum strain, as well as the sensitivity of these properties to changes in the applied strain rate.

Keywords: hopkinson bar, high strain rate, ballistic composites, failure mechanisms.

I. INTRODUCTION

Researches on materials applicable to individual ballistic shielding (ballistic helmet and vest), ballistic vehicles and facilities have the great challenge of increasing the resistance to impact and reducing the product weight, being, therefore, an area of great domain of the polymeric composites¹. The evaluations of the performance of these materials for ballistic armor purposes do not follow the usual standards of characterization of composites, since they are subjected to high strain rates, close to 10^4 s^{-1} , when they are hit by ammunition of small guns (revolver and pistol), as well as fragments of grenades. The drilling power of such weapons is one of the main threats to individual shielding apparatuses (ballistic helmet and vest) and vehicles⁴. Thus, the mechanical assay to be chosen in order to study the dynamic behavior of a polymeric composite for ballistic protection purposes must be capable of imposing near-to-ballistic impact deformation rates^{10, 1}.

From this perspective, the dynamic compression test in a split Hopkinson pressure bar has been considered one of the best and most indicated methods for a more detailed evaluation of the dynamic response of polymeric composites for ballistic protection, since it is robust and has a great capacity to

achieve uniaxial compression strengths in steady regime of strain rates¹¹.

The objective of the present work is to emphasize the importance of the use of the Hopkinson Bar in the evaluation of polymeric composites for ballistic applications. Initially, a brief review of the technical aspects associated with the use of the Hopkinson Bar in dynamic compression tests is presented. Subsequently, the paper presents a review of some recent scientific articles which used this equipment to study dynamic properties of ballistic polymeric composites such as Young's modulus (E), maximum stress (σ_{\max}), strain at maximum stress (ϵ_{σ}), tenacity (J) and maximum strain (ϵ_{\max}), as well as the sensitivity of these properties to changes in the applied strain rate ($\frac{d\epsilon}{dt}$).

II. SPLIT HOPKINSON PRESSURE BAR

The Split Hopkinson Pressure Bar, or simply Hopkinson Bar, is a mechanical characterization equipment used for dynamic compression tests aiming to investigate the response of a material when subjected to high strain rates ($10^2 - 10^4 \text{ s}^{-1}$)¹¹⁻¹³. The equipment was named after the work of Bertram Hopkinson in 1914, who used a cylindrical bar to experimentally estimate the pressure reached by explosive detonations and ammunition shots¹⁴. The structure currently in use, however, was conceived by Kolsky in 1949¹⁵, with some variations, mainly in the propulsion system and in the electronic signal receiving apparatus. In a broad way, it is composed of a gas chamber, an impact or, an incident bar and a transmitter bar. Figure 1 shows a schematic drawing of the equipment, with the names of its main components. In a basic description of its operation, the striker reaches the end of the incident bar driven forward by a large volume of gas suddenly released within the propulsion system.

Author α: Rafael R Dias is with Brazilian Army Technological Center. e-mail: rodrigues.dias@eb.mil.br

Author ο: Iaci Miranda Pereira is with Brazilian Army Technological Center. e-mail: iacipere@gmail.com

Author ρ: Bluma Guenther Soares is with Federal University of Rio de Janeiro. e-mail: bluma@metalmat.ufrj.br

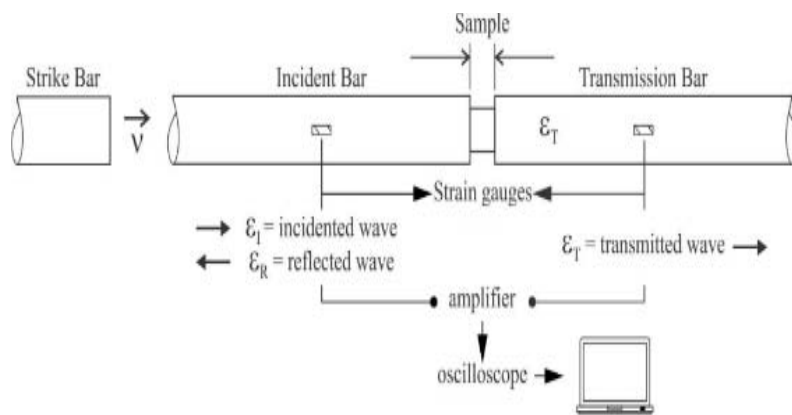

Figure 1: Isometric view of the Hopkinson Bar, with the nomenclature of the main components¹⁶.

As a consequence of the impact of the striker on the incident bar, a compressive stress wave begins its propagation. This wave, upon reaching the interface between the incident bar and the sample, has part of it reflected (voltage pulse) and the remainder is transmitted through the sample as a compression wave¹⁷. Strain-gauges are installed at half the length of each of the two bars of the equipment, capturing the vibration coming from the propagation of mechanical waves. An oscilloscope receives the signals captured, passing them on to an amplification system, which generates charts of Voltage (mV) vs. Time (ms).

incident, reflected and transmitted pulse. These values, in turn, are used in a mathematical model to calculate the tension (σ), strain (ϵ) and strain rate ($\frac{d\epsilon}{dx}$) values which act in the sample; all as a function of time.

The formulations are presented in (1) to (3):
12,13,15,18,19

$$\sigma(t) = \frac{E_b A_b}{A_a} (\epsilon_i + \epsilon_r + \epsilon_t) \quad (1)$$

$$\epsilon = \frac{-2C_b}{L_a} \int_0^t (\epsilon_i + \epsilon_r + \epsilon_t) \quad (2)$$

$$\frac{d\epsilon}{dt} = \frac{-2C_b}{L_a} (\epsilon_i + \epsilon_r + \epsilon_t) \quad (3)$$

where C_b is the speed of propagation of mechanical waves in the bar, A_b and A_a are the cross-sectional areas of the bar and sample, and E_b is the modulus of elasticity of the bar material. These equations are known as the three-wave model.

These three equations, however, were developed considering some boundary conditions which must be verified so that the values adequately represent the properties of the material. The conditions are the following^{11,13,17,20,21}:

1. The incident, transmitter and the striker bars must have the same diameter and be of the same material, being it homogeneous and isotropic. The incident and transmitter bars must have the same length. During the impacts, they must remain in the elastic regime.
2. The propagation of mechanical waves in the incident and transmitter bars is considered one-dimensional. The one-dimensional wave propagation model in bars was developed considering a semi-infinite solid medium. Since this is not in practice possible, the equipment must have sufficiently long incident and transmitter bars to ensure the predominantly one-dimensional propagation of waves. This is achieved by ensuring that the length/diameter ratio of the bars is at least equal to 20.

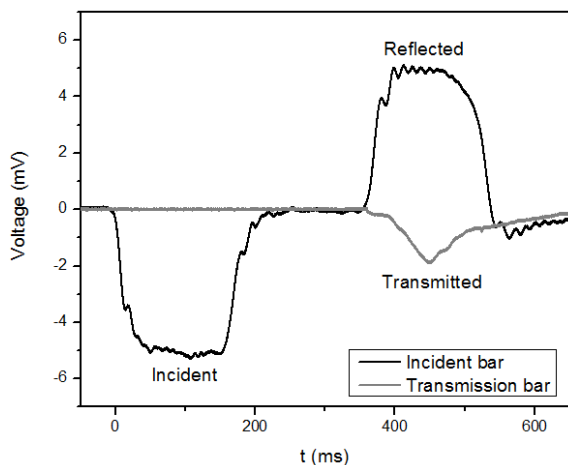

Figure 2: Typical Voltage (mV) vs. Time (ms) chart, in which the incident, reflected and transmitted pulses are identified

Figure2 shows a characteristic example of incident, reflected, and transmitted pulses. The incident and reflected pulses (in blue) are captured by the strain-gauge installed in the incident bar; while the pulse transmitted (in red) by the one installed in the transmitter bar.

The voltage values as a function of time obtained by the strain-gauges are converted into elastic strain values of the bars. We have, then, $\epsilon_i(t)$, $\epsilon_r(t)$ and $\epsilon_t(t)$ as the elastic strains generated, respectively, by the

3. The incident bar/sample and sample/transmitter bar interfaces shall be perfectly flat, with full contact between the sample and the bars.
4. The materials of the sample and bars must have close mechanical impedance. This, in turn, is the product between density and the speed of propagation of the material,(4):

$$Z = \rho C \quad (4)$$

1. The material of the sample cannot be compressible, i.e., the density of the material must not vary with the impact.
2. The test shall take place at stress equilibrium, that is, the stress applied at the incident bar/sample interface shall be convergent with the one generated at the sample/transmitter bar interface.
3. The strain rate to which each sample is subjected must be constant, that is, it cannot vary with the strain of the sample.
4. The sample must have a geometry that minimizes the interfacial friction and inertia effects, since these phenomena generate propagation of bi and/or three-dimensional waves.

Following the conditions outlined above, the mathematical model commonly used presents coherent and reliable results, but there is a natural and acceptable lag between the result obtained by pure application of the theoretical model of one-dimensional wave propagation and the practical result of a dynamic compression test. In the first case, the result would be a pulse of rectangular shape and without oscillations, while the pulse of a test has a trapezoidal profile and oscillations in its plateau (Figure 2). This is due to the propagation of mechanical waves in cylindrical bars being three-dimensional in nature, which implicates the existence of multiple wave frequencies^{19,22,23}.

III. APPLICATION OF HOPKINSON BAR AT ARMOR MATERIALS

In polymeric composites to be used in ballistic protection, the main fibers used as reinforcements are: glass, aramid and ultra-high molecular weight polyethylene (UHMWPE)^{2,3}.

Glass fibers are usually employed in structural polymer composites, whose applications in defense systems are in transportation and constructions susceptible to ballistic impacts and/or wave propagations from explosions, such as bunkers, aircrafts and military vehicles^{1,4,5}. Aramid fibers were developed in 1965 and are routinely used in individual ballistic shielding apparatuses (helmets and ballistic vests), and can also be used in collective shielding apparatuses (military vehicles, utilitarian vehicles and facilities), with DuPont (Kevlar[®]) and Teijin (Twaron[®]) as

its main producers⁶⁻⁸. Ultra high molecular weight polyethylene (UHMWPE) fibers, in turn, were developed in the late 1980s and began to excel in the area of individual ballistic vests during the 1990s⁹. Currently, the prepregs of UHMWPE fibers already dominate individual shielding markets that once were dominated by the aramid fibers, given that they also have high modulus of elasticity and tenacity, but a considerably lower density^{3,5}. Its most known producers are DSM (Dyneema[®]) and Honeywell (SpectraShield[®]).

Table 1 compiles the articles addressed in this work, listing the authors of the articles, the composites studied, the processing used and the strain rates imposed to the material.

Govender et al.³⁷ tested, in a Hopkinson Bar, glass fiber/vinyl ester resin composites, comparing the results of σ_{max} with those of the quasi-static compression test, identifying an increase of 10%. Failure analysis of the samples under optical microscopy indicated delamination, fracture of fibers and fracture plane at 45° in relation to the longitudinal axis.

Tasdemirci et al.³⁸ impacted samples of glass fiber/PS composites, evaluating E and σ_{max} to compare the dynamic and quasi-static behaviors, in longitudinal, transverse and across thickness directions. In all of these, the properties cited increased significantly under dynamic assay.

Zainnudin et al.³⁹ exposed glass fiber/epoxy (pure and nanostructured) composites to interspersed UV radiation/condensation treatments with different durations. The dynamic properties, E and σ_{max} , decreased as the UV/condensation treatment time increased. Compared with equivalent treatment conditions, the nanostructured matrix samples had superior properties than pure matrix composites, under all conditions, which was attributed to better interfacial adhesion, and therefore less delamination in comparison with the other compositions.

Kim et al.⁴⁰ produced glass fiber/polyester (pure and CNT) and glass fiber/polyurethane (pure and CNT) composites. Dynamic compression tests were used to compare the impact absorption capacity of each composite, with and without the treated fiber layers, and found that the greatest ϵ_{max} and J were obtained by the glass fiber/polyurethane/CNT composite.

Arbaoui et al.⁴¹ studied the compressive properties in the plane (fiber-weft direction), E, σ_{max} and ϵ_{σ} , of glass fiber woven fabric/vinyl ester resin composites, of bi- or three- dimensional woven fabrics. The 3D woven fabric composites showed superior properties at all rates employed, especially for σ_{max} , in which the 2D woven fabric showed a decline in the highest rates employed.

Tarfaoui et al.⁴² processed glass fiber/epoxy composites, presenting in a dynamic test a reasonable

sensitivity to the increase of $\frac{d\varepsilon}{dt}$, when displaying greater ε_{\max} and J whilst receiving greater impact pressures. Using high-speed infrared camera, the authors verified that the impact energy was dissipated through matrix rupture, delamination and fiber breakage; mechanisms which became more present as $\frac{d\varepsilon}{dt}$ increased.

Researchers Woo and Kim⁴³ processed aramid/phenolic resin prepregs, which presented, in tests of dynamic compression, sensitivity to small variations of $\frac{d\varepsilon}{dt}$, with linear growth of σ_{\max} (233%) and J (211%). The variable ε_{σ} of the composite, on the other hand, presented a slight reduction (16%) with the increase of $\frac{d\varepsilon}{dt}$. SEM images and acoustic emission signals indicated matrix rupture, delamination, fiber tearing and rupture as the main failure mechanisms. The researchers concluded that with the increase of the impact energy, the samples presented fragile fractures in greater volume and faster, reducing its strain capacity, justifying the reduction of ε_{σ} . In the subsequent work by the same authors⁴⁴, a hybrid woven fabric composed of carbon fibers (weft) and para-aramid (warp) was used, with the same resin and same fiber/matrix ratio as Woo and Kim⁴³. The properties showed sensitivity to variations of $\frac{d\varepsilon}{dt}$, but more discreet.

The σ_{\max} , however, were 1.6x higher than those obtained in the previous study⁴³. In addition to all failure mechanisms present in the aramid fiber composite, there was a fragile fracture of the carbon fibers, which contributed to increase the impact resistance of the material, expressed in the increase of σ_{\max} .

Chouhan et al.⁴⁶ worked with aramid/PP-co-AM (10%) composites, testing samples with different amounts of fabric layers (16, 24 and 30) and therefore different e/d ratios, in order to study the quality of the results obtained in each geometry, observing the best dynamic properties in the 24-layer composite. Kapoor et al.⁴⁵, in turn, tested, at 6 different strain rates, the composite that presented the best conditions in Chouhan et al.⁴⁶, developed equations for the dynamic properties as a function of $\frac{d\varepsilon}{dt}$ and compared the results with those of Woo and Kim⁴³. The composite presented second-order growth of J and linear growth of ε_{σ} , therefore greater than the aramid/phenolic resin tested in⁴³. The higher impact absorption capacity of the material was associated with the ductility of the thermoplastic matrix and the higher fiber/matrix adhesion ensured by the presence of maleic anhydride.

Bandaru et al.⁴⁷ manufactured aramid/PP and aramid/basalt/PP composites, testing all of them on a Hopkinson Bar. The composite of hybrid woven fabric obtained superior results of E and σ_{\max} due to higher fiber/matrix adhesion of the basalt/PP composite. The fragility of the basalt, however, made the hybrid

composites present a decrease in ε_{σ} with the increase of $\frac{d\varepsilon}{dt}$, whereas the homogeneous aramid/PP composite showed growth in this value in the same situation, corroborating the results obtained with two-dimensional fabrics^{45,46}.

Qian et al.⁴⁸ tested samples of aramid/PA₆ composite plates, with different fiber/matrix ratios, analyzing the response of each material to the increase in the impact energy, as well as the influence of the variation in the thickness/diameter ratio on the dynamic properties of the material. They concluded that, regardless of the composition, all of them presented sensitivity to $\frac{d\varepsilon}{dt}$ and compositions with higher fiber volume presented higher E and σ_{\max} ; and smaller ε_{\max} .

Table 1: Compilation of the studied authors, their materials, processes employed and observations on the tests

References	Composites studied	Processing	Strain Rates (s ⁻¹)	Observations
Govender et al. ³⁷	Plain glass fiber fabric E/vinyl ester (Derakane® 8084)	RTM	~ 520	Use of a conical striker to reduce the variation of the strain rate between tests.
Tasdemirciet al. ³⁸	Quadri-axial glass fiber Fabric E [0/45/90/-45]/polyester (Crystic® 702PAX)	VARTM	~ 900	The tests were recorded by a high-speed camera in order to study the strain mechanisms and to compare them with those presented in the finite element program developed by the authors.
Zainuddin et al. ³⁹	Unidirectional non-woven glass fiber E (FiberGlast) / epoxy (S-15®) / montmorillonite nanofiller (Nanomer® I. 28E)	RTM	382 440 510	The composites were submitted to treatments that interspersed 4h of UV radiation and 4h of condensation, with different durations (5, 10 and 15 days).
Kim et al. ⁴⁰	Plain glass fiber fabric / PS / CNT Plain Fiberglass Fabric / PU / CNT	Autoclaving	700	Composites with 13 layers of pure glass fiber fabric and composites with 3 of the 13 layers of fabrics reinforced by vertically aligned carbon nanotubes (VACNT) were processed.
Arbaoui et al. ⁴¹	Bi-dimensional and three-dimensional glass fiber fabrics E (EADS composites) / vinyl ester (DION® 9102)	Vacuum resin infusion	224-882	The three-dimensional composites employed are composed of 6% in volumes of polystyrene fibers oriented in the Z direction.
Tarfaii et al. ⁴²	Unidirectional non-woven glass fiber E/Epoxy (EPOLAM®)	Vacuum resin infusion	285 - 1430	Use of thermocouples and high-speed infrared cameras to monitor the temperature change of the samples during the test.
Woo and Kim ⁴³	758 HPP® (acronym of Helmet Phenolic Prepreg, from DuPont)	Hot Compression	1182 1322 1460	Use of the acoustic emission technique to evaluate the failure mechanisms of the composite during the dynamic compression test.
Woo and Kim ⁴⁴	Twill carbon fibers woven T-300® and aramid K49® (DuPont) / phenol-formaldehyde	Hot Compression	1007 1485 1927	Tests on the Hopkinson Bar were used to determine the best thickness/diameter ratio for the composite tested.
Kapoor et al. ⁴⁵	Plain aramid fiber fabric K29® (Dupont) / polypropylene-maleic	Vacuum-assisted hot compression	2101 - 9965	Maleic anhydride was used as a compatibilizer in the polypropylene matrix to increase the fiber/matrix adhesion.
Chouhan et al. ⁴⁶	co-anhydride (PP-co-AM)	Hot	1370-4264	Use of three-dimensional hybrid fabrics of para-aramid/basalt in the ballistic plate processing.
Bandaru et al. ⁴⁷	Kevlar® plain aramid fiber fabric/ Basalt fiber/ Polypropylene	Vacuum-assisted hot compression	3633-5235	Processing of composites with different
Qian et al. ⁴⁸	Plain aramid fiber fabric	Hot	456	

	K29®/polyamide (PA ₆)	Compression	782 1153	fiber/matrix ratios, investigating the influence of this parameter on the dynamic results.
Cao et al. ⁴⁹	Kevlar plain aramid fiber woven® / Non-Newtonian Fluid	Hand Layup	4318 6438 8702	The feasibility of a non-Newtonian fluid as a composite matrix to be subject to high strain rates was verified.
He et al. ⁵⁰	Plain aramid fabric K129®/Non-Newtonian Fluid/Stiffening Gel	Hand Layup	4318	Use of a stiffening gel to accommodate the non-Newtonian fluid, as a way of better distributing it through the fibers.
Pagnocelli et al. ¹⁶	Plain aramid fiber fabric K29® / Vinyl ester (Derakane® 411-350)	MTR	2000	Samples were drawn from five different areas of 300 mm x 300 mm ballistic plates using the dynamic assay to verify the homogeneity of plate impact response.
Rabbi et al. ⁵¹	Kevlar® plain aramid fiber fabric/epoxy Kevlar® auxetic woven/epoxy	Vacuum infusion	1200-3300	Processing of composites with auxetic aramid woven and nanocomposite epoxy resin / Nylon short fibers.
Shaker et al. ⁵²	Dyneema H62® / LDPE Dyneema H5T® / LDPE Twaron CT 736® (Teijin)/LDPE ArtecRussian® /LDPE K49®/LDPE	Autoclaving	1000-8000	Woven and non-woven aramid and/or UHMWPE were used in the composites co-processing.
Shi et al. ⁵³	UD75® prepreg (ZhongtaiInc)	Hot Compression	430 840 1200	Processing of the composites by turning the adjacent blades at specific angles, in order to obtain different directions of fibers.
Parker and Ramesh ⁵⁴	Dyneema HB80® prepreg (DSM)	Hot Compression	3500	Study of different processing pressures and their effect on the dynamic response of the material.
Zhu et al. ⁵⁵	UHMWPE/Polyurethane	Hot Compression	1000-3000	Hygrothermal treatment performance, at different execution times, and comparison with the resistance to impact of the untreated composite.
Asija et al. ⁵⁶	GoldShield® (Honeywell) treated in non-Newtonian fluid	Hot Compression	3000-10000	Prepregs were subjected to treatment in non-Newtonian fluid prior to processing.
Asija et al. ⁵⁷	GoldShield® (Honeywell)/polymer foam film soaked with non-Newtonian fluid	Hot Compression	3000-10000	Use of a foam film soaked with a non-Newtonian fluid, arranged between the prepregs to disperse the liquid through the composite.
Fin et al.	Tensylon® (DuPont) Plain aramid fiber woven K29®/Ethylene Vinyl Acetate (EVA)	Autoclaving	~2050	UHMWPE non-woven co-processing and para-aramid/EVA woven in three different ratios (25/75, 50/50 and 75/25, respectively), comparing the results of dynamic impacts with the respective homogeneous composites.

Cao et al.⁴⁹ studied mechanical and energy absorption properties of aramid/non-Newtonian fluid by subjecting composites of different fiber/matrix ratios to the same impact energy. Higher percentages of non-Newtonian fluid ensured an increase of E and J, which was attributed to the ability of the matrix to, once it adhered to the fibers, hinder the interlaminar shear and delamination of the composite. Noting this result, He et al.⁵⁰ modified the research material using as a matrix a stiffening gel soaked with a non-Newtonian fluid. In comparison to ⁴⁹, the values of E did not present significant variations and there was a 10% decrease in J.

Pagnocelli et al.¹⁶ used the dynamic compression test on samples taken from 5 different regions of aramid/vinyl-ester ballistic plates in order to verify if the distribution of the matrix through the fabrics occurred homogeneously during processing. The authors used σ_{\max} and J in this comparison, verifying that the peripheral regions obtained statistically equal properties, while the central region obtained mechanical property values 20% lower, an event associated to the fact that this region accumulated a larger volume of resin, making it fragile.

Rabbi et al.⁵¹ used the tests in a Hopkinson Bar to compare two aramid/epoxy composites: one flat and one auxetic woven fabric. In both cases, the epoxy resin was impregnated with short Nylon fibers®, to study the dynamic responses of composites with or without short fibers in the matrix. The authors observed that all composites showed an increase in the values of ϵ_{\max} and σ_{\max} as a function of $\frac{d\epsilon}{dt}$, and this sensitivity was higher for plane aramid/pure epoxy resin fabric composites. For the composite of auxetic fabric, however, the nanostructured resin was more efficient than the pure one. This was due to the greater spacing in the auxetic fabric, with the short fibers being able to penetrate through the fabric and remain oriented along the direction of impact, increasing the strength of the composite.

Shaker et al.⁵² tested homogeneous and hybrid composites of several aramid and UHMWPE fibers, all processed with LDPE matrix. The stress-strain and J behaviors were studied by the researchers, who verified that, in all $\frac{d\epsilon}{dt}$, the unidirectional/LDPE homogeneous composite CT736® showed the highest σ_{\max} values, while the hybrid composite CT736® fabric + Artec® fabric/LDPE presented the best results of J.

Shi et al.⁵³ investigated the energy absorption variation of UHMWPE/LDPE composites by modifying the fiber angulation by rotating the prepreg lamina in relation to the adjacent one. The researchers observed a significant increase in J in multi-oriented fiber composites.

Parker and Ramesh⁵⁴ used the Hopkinson Bar in UHMWPE/polyurethane composites, Dyneema HB80®, processed via compression at different pressures, 1 ksi and 5 ksi. The composite submitted to processing at higher pressure presented higher stiffness, E, and also larger J.

Zhu et al.⁵⁵ subjected to dynamic compression tests samples of UHMWPE/polyurethane which underwent hydrothermal treatment. The σ_{\max} of samples treated for 12 days increased with $\frac{d\epsilon}{dt}$; the opposite occurred with samples that underwent 24 days of treatment. Effects of matrix plastifying dominated the dynamic compression properties for the first 12 days, while the degradation of the fiber/matrix interface and the expansion of the internal gaps played more important roles in samples that underwent 24-hour treatment.

Asija et al.⁵⁶ tested ballistic prepreg Golden Shield® composites, treated for 4 hours in non-Newtonian fluid, comparing it with the untreated composite. Both had sensitivity to $\frac{d\epsilon}{dt}$; and the treated composite presented steep growth of σ_{\max} and J, while the pure composite presented softer growths. The silica nanoparticles present in the fluid, when lodging between the fibers require greater efforts for the occurrence of failure mechanisms such as interlaminar and interfiber shear. The same group⁵⁷, in a subsequent work, used a PP-co-AM polymeric foam film to absorb the non-Newtonian fluid, with further co-processing with GoldShield® ballistic prepreps. The results in the dynamic compression test of these composites were much lower than in the previous work, since there was no efficient interaction of the non-Newtonian fluid with the UHMWPE fibers, only with the PP-co-AM foam film.

Fin et al. co-processed Tensylon® and aramid/EVA prepreps in 3 different compositions, in addition to their respective homogeneous composites. Subject to dynamic compression tests, all at the same rate, the composites showed linear growth of σ_{\max} and J as a function of the increase of the percentage of Tensylon® layers; and the homogeneous composite of this material presented, therefore, the most expressive results.

IV. CONCLUSION

It can be understood from this review that the dynamic compression test in split Hopkinson pressure bar is an efficient method for evaluating the efficiency of ballistic polymeric composites, although there is still limited literature on the subject. Whether comparing it to the quasi-static regime or using several dynamic tests, the authors investigated the effect of an increase in the strain rate ($\frac{d\epsilon}{dt}$) in compression properties. The ballistic composites are sensitive to this parameter, presenting

an increase in Maximum Stress (σ_{max}) and Tenacity (J). The comparison between articles indicates that composites with thermoplastic matrices tend to have growing properties related to strain (ϵ_{σ} and ϵ_{max}), while the thermo rigid composites have decreasing properties as higher rates are applied. The authors also sought to observe and understand the several failure mechanisms during impact, and matrix rupture, delamination and fiber rupture were highlighted.

REFERENCES RÉFÉRENCES REFERENCIAS

- Bhatnagar, A. *Lightweight ballistic composites*. (CRC, 2006).
- Chawla, K. K. *Composite Materials: Science and Engineering*. (Springer, 2012).
- Pegoretti, A., Traina, M. & Vlasblom, M. in *Handbook of Properties of Textiles and Technical Fibres* (ed. Bunsell, A. R.) 638–991 (The Textile Institute Book Series., 2018).
- Crouch, I. in *The Science of Armour Materials*. (ed. Crouch, I.) 1–54 (Elsevier Ltd., 2017).
- Hazell, P. J. *Armour: Materials, Theory and Design*. (CRC Press., 2016).
- Hamouda, A. M. S., Sohaimi, R. M., Zaidi, A. M. A. & Abdullah, S. in *Advance in military textiles and personnel equipments*. (ed. Sparks, E.) 103–138 (Woodhead Publishing, 2012).
- Rebouillat, S. in *Advanced Fibrous Composite Materials for Ballistic Protection*. (ed. Chen, X.) (Woodhead Publishing., 2016).
- Jackson, T. & Samanta, S. Characterization of Kevlar Fiber and Its Composites : A Review. *Mater. Today Proc.* 2, 1381–1387 (2015).
- Crouch, I. G., Sandlin, J. & Thomas, S. in *The Science of Armour Materials*. (ed. Crouch, I.) 203–268 (Elsevier Ltd., 2017). doi:10.1016/B978-0-08-100704-4.00005-0
- Vaidya, U. K. in *Impact Engineering of Composite Structures*. (ed. Abrate, S.) 97–192 (Springer Wien., 2011).
- Gray III, G. T. (Rusty). in *ASM Handbook Vol. 8 - Mechanical Testing and Evaluation*. (eds. Kuhn, H. & Medlin, D.) 1027–1046 (ASTM International., 2000).
- Meyers, M. *Dynamic Behavior of Material*. (John Wiley and Sons, Inc., 1994).
- Chen, W. W. & Song, B. *Split Hopkinson (Kolsky) Bar: Design, Testing and Applications*. (Springer, 2011).
- Hopkinson, B. A Method of Measuring the Pressure Produced the Detonation Explosives or by the Impact of Bullets. *Philos. Trans. R. Soc. AA* 213, 437–456 (1914).
- Kolsky, H. An investigation of the mechanical properties of materials at very high rates of loading. *Proc. Phys. Soc. London, Sect. B62*, 676–700 (1949).
- Pagnoncelli, M. *et al.* Mechanical and ballistic analysis of aramid/vinyl ester composites. *J. Compos. Mater.* 0, 1–11 (2017).
- Field, J. E., Walley, S. M., Proud, W. G., Goldrein, H. T. & Siviour, C. R. Review of experimental techniques for high rate strain and shock studies. *Int. J. Impact Eng.* 30, 725–775 (2004).
- Davies, E. D. H. & Huntet, S. C. The dynamic compression testing of solids by the method of the split Hopkinson pressure bar. *J. Mech. Phys. Solids* 11, 155–179 (1963).
- Follansbee, P. S. & Frantz, C. Wave Propagation in the Split Hopkinson Pressure Bar. *J. Eng. Mater. Technol.* 105, 61–66 (1983).
- Gama, B. A., Lopatnikov, S. L. & Gillespie Jr., J. W. Hopkinson Bar Experimental Technique : A Critical Review. *Appl. Mech. Rev.* 57, 223–250 (2004).
- Wu, X. & Gorham, D. Stress Equilibrium in the Split Hopkinson Pressure Bar Test. *J. Phys.* IV, C3-91-C3-96 (1997).
- Gorham, D. A. A numerical method for the correction of dispersion in pressure bar signals. *J. Phys.* IV. 477–479 (1983).
- Ren, L., Larson, M., Gama, B. A. & Gillespie, J. W. *Wave Dispersion in Cylindrical Tubes : Applications to Hopkinson Pressure Bar Experimental Techniques*. (2004).
- Hosur, M. V, Alexander, J., Vaidya, U. K. & Jeelani, S. High strain rate compression response of carbon / epoxy laminate composites. *Compos. Struct.* 52, 405–417 (2001).
- Naik, N. K. & Kavala, V. R. High strain rate behavior of woven fabric composites under compressive loading. *Mater. Sci. Eng.* 474, 301–311 (2009).
- Dias, R. R., Sousa, S. D., Patrício, P. S. O. & Pereira, I. M. Influence of thickness/diameter ratio on strain hardening behavior of high molecular weight polyethylene after dynamical compressive tests using Hopkinson pressure bar. in *30th International Symposium on Ballistics*. 2629–2640 (Destech Publication., 2017). doi:10.12783/ballistics2017/17047
- Brown, E. N. *et al.* Influence of Molecular Conformation on the Constitutive Response of Polyethylene : A Comparison of HDPE, UHMWPE and PEX. *Exp. Mech.* 47, 381–393 (2007).
- Naik, N. K., Pandya, K. S., Ponthnis, J. R. & Gelu, T. A. Revisiting Kolsky bar data evaluation method. *Compos. Struct.* 111, 446–452 (2014).
- Pan, Y., Chen, W. & Song, B. Upper Limit of Constant Strain Rates in a Split Hopkinson Pressure Bar Experiment with Elastic Specimens. *Exp. Mech.* 34, 440–446 (2005).
- Naik, N. K., Ch, V. & Kavala, V. R. Hybrid composites under high strain rate compressive loading. *Mater. Sci. Eng.* 47, 87–99 (2009).

31. Gorham, D. AN EFFECT OF SPECIMEN SIZE IN THE HIGH STRAIN RATE COMPRESSION TEST. *J. Phys. IV*, C3-411-C3-418 (1991).
32. Zhong, W. Z. *et al.* Influence of interfacial friction and specimen configuration in Split Hopkinson Pressure Bar system. *Tribol. Int.* 90, 1–14 (2015).
33. Iwamoto, T. & Yokoyama, T. Effects of radial inertia and end friction in specimen geometry in split Hopkinson pressure bar tests: A computational study. *Mech. Mater.* 51, 97–109 (2012).
34. Arjun, S. & Sen, O. Effect of Specimen Size in the Kolsky Bar. *Procedia Eng.* 10, 2663–2671 (2011).
35. Lindholm, U. S. Some experiments with the split Hopkinson pressure bar. *J. Mech. Phys. Solids* 12, 317–335 (1964).
36. Samanta, S. K. DYNAMIC strain OF ALUMINIUM AND COPPER AT ELEVATED TEMPERATURES. *J. Mech. Phys. Solids* 19, 117–135 (1971).
37. Govender, R. A., Louca, L. A., Pullen, A., Fallah, A. S. & Nurick, G. N. Determining the through-thickness properties of thick glass fiber reinforced polymers at high strain rates. *J. Compos. Mater.* 46, 1219–1228 (2012).
38. Tasdemirci, A. *et al.* Experimental and Numerical Investigation of High Strain Rate Glass/Polyester Composite. *Procedia Eng.* 10, 3068–3073 (2011).
39. Zainuddin, S., Hosur, M. V., Barua, R. & Kumar, A. Effects of ultraviolet radiation and condensation on static and dynamic compression behavior of neat and nanoclay infused epoxy/glass composites. *J. Compos. Mater.* 45, 1901–1918 (2011).
40. Kim, K. *et al.* Dynamic Mechanical Analysis and High Strain-Rate Energy Absorption Characteristics of Vertically Aligned Carbon Nanotube Reinforced Woven Fiber-Glass Composites. *J. Nanomater.* 7 pages (2015). doi:10.1155/2015/480549
41. Arbaoui, J., Tarfaoui, M., Bouery, C., El, A. & Alaoui, M. Comparative study of mechanical properties and damage kinetics of two- and three-dimensional woven composites under high-strain rate dynamic compressive loading. *Int. J. Damage Mech.* 25, 878–899 (2016).
42. Tarfaoui, M., Moumen, A. El & Yahia, H. Ben. Damage detection versus heat dissipation in E-glass / Epoxy laminated composites under dynamic compression at high strain rate. *Compos. Struct.* 186, 50–61 (2018).
43. Woo, S. & Kim, T. High-strain-rate impact in Kevlar-woven composites and fracture analysis using acoustic emission. *Compos. Part B* 60, 125–136 (2014).
44. Woo, S. & Kim, T. High strain-rate failure in carbon/Kevlar hybrid woven composites via a novel SHPB-AE coupled test. *Compos. Part B* 97, 317–328 (2016).
45. Kapoor, R., Pangenji, L., Kumar, A. & Ahmad, S. High strain rate compression response of woven Kevlar reinforced polypropylene composites. *Compos. Part B* 89, 374–382 (2016).
46. Chouhan, H., Asija, N., Amare, S. & Bhatnagar, N. Effect of Specimen Thickness on High Strain Rate Properties of Kevlar/Polypropylene Composite. *Procedia Eng.* 173, 694–701 (2017).
47. Bandaru, A. *et al.* Characterization of 3D angle-interlock thermoplastic composites under high strain rate compression loadings. *Polym. Test.* 62, 355–365 (2017).
48. Qian, X., Wang, H., Zhang, D. & Wen, G. High strain rate out-of-plane compression properties of aramid fabric reinforced polyamide composite. *Polym. Test.* 53, 314–322 (2016).
49. Cao, S. *et al.* High strain-rate dynamic mechanical properties of Kevlar fabrics impregnated with shear thickening fluid. *Compos. Part A* 100, 161–169 (2017).
50. He, Q. *et al.* Impact resistance of shear thickening fluid/Kevlar composite treated with shear-stiffening gel. *Compos. Part A* 106, 82–90 (2017).
51. Rabbi, F., Chalivendra, V. & Kim, Y. Dynamic constitutive response of novel auxetic Kevlar/epoxy composites. *Compos. Struct.* 195, 1–13 (2018).
52. Shaker, K., Jabbar, A., Karahan, M., Karahan, N. & Nawab, Y. Study of dynamic compressive behaviour of aramid and ultrahigh molecular weight polyethylene composites using Split Hopkinson Pressure Bar. *J. Compos. Mater.* 51, 81–94 (2017).
53. Shi, B., Sun, Y., Chen, L. & Li, J. Energy Absorption of Ultra-High Molecular Weight Polyethylene Fiber-reinforced Laminates at High Strain Rates. *Appl. Mech. Mater.* 35, 1532–1535 (2010).
54. Parker, J. & Ramesh, K. T. Effect of Microstructure on the Transverse Compressive Strength of UHMWPE Composites at High Strain-rates. 1 (2016).
55. Zhu, L., Li, Y., Zhu, X. & Zhu, Z. Compressive mechanics and failure mechanism for UHMWPE fiber reinforced composite laminated under hygrothermal environment. in *International Conference of Composite Materials*. 20–25 (2017).
56. Asija, N., Chouhan, H., Gebremeskel, S. A., Singh, R. K. & Bhatnagar, N. High strain rate behavior of STF-treated UHMWPE composites. *Int. J. Impact Eng.* 110, 359–364 (2017).
57. Asija, N., Chouhan, H., Gebremeskel, S. A. & Bhatnagar, N. Impact response of Shear Thickening Fluid (STF) treated ultra high molecular weight poly ethylene composites – study of the effect of STF treatment method. *Thin Walled Struct.* 126, 16–25 (2018).

GLOBAL JOURNALS GUIDELINES HANDBOOK 2019

WWW.GLOBALJOURNALS.ORG

FELLOWS

FELLOW OF ASSOCIATION OF RESEARCH SOCIETY IN ENGINEERING (FARSE)

Global Journals Incorporate (USA) is accredited by Open Association of Research Society (OARS), U.S.A and in turn, awards “FARSE ” title to individuals. The 'FARSE' title is accorded to a selected professional after the approval of the Editor-in-Chief /Editorial Board Members/Dean.



- The “FARSE” is a dignified title which is accorded to a person’s name viz. Dr. John E. Hall, Ph.D., FARSE or William Walldroff, M.S., FARSE.

FARSE accrediting is an honor. It authenticates your research activities. After recognition as FARSE, you can add 'FARSE' title with your name as you use this recognition as additional suffix to your status. This will definitely enhance and add more value and repute to your name. You may use it on your professional Counseling Materials such as CV, Resume, and Visiting Card etc.

The following benefits can be availed by you only for next three years from the date of certification:



FARSE designated members are entitled to avail a 40% discount while publishing their research papers (of a single author) with Global Journals Incorporation (USA), if the same is accepted by Editorial Board/Peer Reviewers. If you are a main author or co-author in case of multiple authors, you will be entitled to avail discount of 10%.

Once FARSE title is accorded, the Fellow is authorized to organize a symposium/seminar/conference on behalf of Global Journal Incorporation (USA).The Fellow can also participate in conference/seminar/symposium organized by another institution as representative of Global Journal. In both the cases, it is mandatory for him to discuss with us and obtain our consent.



You may join as member of the Editorial Board of Global Journals Incorporation (USA) after successful completion of three years as Fellow and as Peer Reviewer. In addition, it is also desirable that you should organize seminar/symposium/conference at least once.

We shall provide you intimation regarding launching of e-version of journal of your stream time to time.This may be utilized in your library for the enrichment of knowledge of your students as well as it can also be helpful for the concerned faculty members.





The FARSE can go through standards of OARS. You can also play vital role if you have any suggestions so that proper amendment can take place to improve the same for the benefit of entire research community.

As FARSE, you will be given a renowned, secure and free professional email address with 100 GB of space e.g. johnhall@globaljournals.org. This will include Webmail, Spam Assassin, Email Forwarders, Auto-Responders, Email Delivery Route tracing, etc.

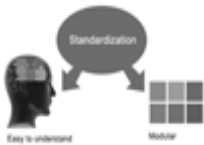

The FARSE will be eligible for a free application of standardization of their researches. Standardization of research will be subject to acceptability within stipulated norms as the next step after publishing in a journal. We shall depute a team of specialized research professionals who will render their services for elevating your researches to next higher level, which is worldwide open standardization.

The FARSE member can apply for grading and certification of standards of their educational and Institutional Degrees to Open Association of Research, Society U.S.A. Once you are designated as FARSE, you may send us a scanned copy of all of your credentials. OARS will verify, grade and certify them. This will be based on your academic records, quality of research papers published by you, and some more criteria. After certification of all your credentials by OARS, they will be published on your Fellow Profile link on website <https://associationofresearch.org> which will be helpful to upgrade the dignity.



The FARSE members can avail the benefits of free research podcasting in Global Research Radio with their research documents. After publishing the work, (including published elsewhere worldwide with proper authorization) you can upload your research paper with your recorded voice or you can utilize chargeable services of our professional RJs to record your paper in their voice on request.

The FARSE member also entitled to get the benefits of free research podcasting of their research documents through video clips. We can also streamline your conference videos and display your slides/ online slides and online research video clips at reasonable charges, on request.





The FARSE is eligible to earn from sales proceeds of his/her researches/reference/review Books or literature, while publishing with Global Journals. The FARSE can decide whether he/she would like to publish his/her research in a closed manner. In this case, whenever readers purchase that individual research paper for reading, maximum 60% of its profit earned as royalty by Global Journals, will

be credited to his/her bank account. The entire entitled amount will be credited to his/her bank account exceeding limit of minimum fixed balance. There is no minimum time limit for collection. The FARSE member can decide its price and we can help in making the right decision.

The FARSE member is eligible to join as a paid peer reviewer at Global Journals Incorporation (USA) and can get remuneration of 15% of author fees, taken from the author of a respective paper. After reviewing 5 or more papers you can request to transfer the amount to your bank account.



MEMBER OF ASSOCIATION OF RESEARCH SOCIETY IN ENGINEERING (MARSE)

The 'MARSE ' title is accorded to a selected professional after the approval of the Editor-in-Chief / Editorial Board Members/Dean.

The “MARSE” is a dignified ornament which is accorded to a person’s name viz. Dr. John E. Hall, Ph.D., MARSE or William Walldroff, M.S., MARSE.



MARSE accrediting is an honor. It authenticates your research activities. After becoming MARSE, you can add 'MARSE' title with your name as you use this recognition as additional suffix to your status. This will definitely enhance and add more value and repute to your name. You may use it on your professional Counseling Materials such as CV, Resume, Visiting Card and Name Plate etc.

The following benefits can be availed by you only for next three years from the date of certification.



MARSE designated members are entitled to avail a 25% discount while publishing their research papers (of a single author) in Global Journals Inc., if the same is accepted by our Editorial Board and Peer Reviewers. If you are a main author or co-author of a group of authors, you will get discount of 10%.

As MARSE, you will be given a renowned, secure and free professional email address with 30 GB of space e.g. johnhall@globaljournals.org. This will include Webmail, Spam Assassin, Email Forwarders, Auto-Responders, Email Delivery Route tracing, etc.





We shall provide you intimation regarding launching of e-version of journal of your stream time to time. This may be utilized in your library for the enrichment of knowledge of your students as well as it can also be helpful for the concerned faculty members.

The MARSE member can apply for approval, grading and certification of standards of their educational and Institutional Degrees to Open Association of Research, Society U.S.A.



Once you are designated as MARSE, you may send us a scanned copy of all of your credentials. OARS will verify, grade and certify them. This will be based on your academic records, quality of research papers published by you, and some more criteria.

It is mandatory to read all terms and conditions carefully.



AUXILIARY MEMBERSHIPS

Institutional Fellow of Open Association of Research Society (USA)-OARS (USA)

Global Journals Incorporation (USA) is accredited by Open Association of Research Society, U.S.A (OARS) and in turn, affiliates research institutions as “Institutional Fellow of Open Association of Research Society” (IFOARS).

The “FARSC” is a dignified title which is accorded to a person’s name viz. Dr. John E. Hall, Ph.D., FARSC or William Walldroff, M.S., FARSC.



The IFOARS institution is entitled to form a Board comprised of one Chairperson and three to five board members preferably from different streams. The Board will be recognized as “Institutional Board of Open Association of Research Society”-(IBOARS).

The Institute will be entitled to following benefits:



The IBOARS can initially review research papers of their institute and recommend them to publish with respective journal of Global Journals. It can also review the papers of other institutions after obtaining our consent. The second review will be done by peer reviewer of Global Journals Incorporation (USA) The Board is at liberty to appoint a peer reviewer with the approval of chairperson after consulting us.

The author fees of such paper may be waived off up to 40%.

The Global Journals Incorporation (USA) at its discretion can also refer double blind peer reviewed paper at their end to the board for the verification and to get recommendation for final stage of acceptance of publication.



The IBOARS can organize symposium/seminar/conference in their country on behalf of Global Journals Incorporation (USA)-OARS (USA). The terms and conditions can be discussed separately.

The Board can also play vital role by exploring and giving valuable suggestions regarding the Standards of “Open Association of Research Society, U.S.A (OARS)” so that proper amendment can take place for the benefit of entire research community. We shall provide details of particular standard only on receipt of request from the Board.



Journals Research
inducing researches

The board members can also join us as Individual Fellow with 40% discount on total fees applicable to Individual Fellow. They will be entitled to avail all the benefits as declared. Please visit Individual Fellow-sub menu of GlobalJournals.org to have more relevant details.



We shall provide you intimation regarding launching of e-version of journal of your stream time to time. This may be utilized in your library for the enrichment of knowledge of your students as well as it can also be helpful for the concerned faculty members.

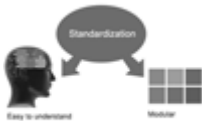

After nomination of your institution as “Institutional Fellow” and constantly functioning successfully for one year, we can consider giving recognition to your institute to function as Regional/Zonal office on our behalf. The board can also take up the additional allied activities for betterment after our consultation.

The following entitlements are applicable to individual Fellows:

Open Association of Research Society, U.S.A (OARS) By-laws states that an individual Fellow may use the designations as applicable, or the corresponding initials. The Credentials of individual Fellow and Associate designations signify that the individual has gained knowledge of the fundamental concepts. One is magnanimous and proficient in an expertise course covering the professional code of conduct, and follows recognized standards of practice.



Open Association of Research Society (US)/ Global Journals Incorporation (USA), as described in Corporate Statements, are educational, research publishing and professional membership organizations. Achieving our individual Fellow or Associate status is based mainly on meeting stated educational research requirements.

Disbursement of 40% Royalty earned through Global Journals : Researcher = 50%, Peer Reviewer = 37.50%, Institution = 12.50% E.g. Out of 40%, the 20% benefit should be passed on to researcher, 15 % benefit towards remuneration should be given to a reviewer and remaining 5% is to be retained by the institution.



We shall provide print version of 12 issues of any three journals [as per your requirement] out of our 38 journals worth \$ 2376 USD.

Other:

The individual Fellow and Associate designations accredited by Open Association of Research Society (US) credentials signify guarantees following achievements:

- The professional accredited with Fellow honor, is entitled to various benefits viz. name, fame, honor, regular flow of income, secured bright future, social status etc.



- In addition to above, if one is single author, then entitled to 40% discount on publishing research paper and can get 10% discount if one is co-author or main author among group of authors.
- The Fellow can organize symposium/seminar/conference on behalf of Global Journals Incorporation (USA) and he/she can also attend the same organized by other institutes on behalf of Global Journals.
- The Fellow can become member of Editorial Board Member after completing 3yrs.
- The Fellow can earn 60% of sales proceeds from the sale of reference/review books/literature/publishing of research paper.
- Fellow can also join as paid peer reviewer and earn 15% remuneration of author charges and can also get an opportunity to join as member of the Editorial Board of Global Journals Incorporation (USA)
- • This individual has learned the basic methods of applying those concepts and techniques to common challenging situations. This individual has further demonstrated an in-depth understanding of the application of suitable techniques to a particular area of research practice.

Note :

//

- In future, if the board feels the necessity to change any board member, the same can be done with the consent of the chairperson along with anyone board member without our approval.
- In case, the chairperson needs to be replaced then consent of 2/3rd board members are required and they are also required to jointly pass the resolution copy of which should be sent to us. In such case, it will be compulsory to obtain our approval before replacement.
- In case of “Difference of Opinion [if any]” among the Board members, our decision will be final and binding to everyone.

//



PREFERRED AUTHOR GUIDELINES

We accept the manuscript submissions in any standard (generic) format.

We typeset manuscripts using advanced typesetting tools like Adobe In Design, CorelDraw, TeXnicCenter, and TeXStudio. We usually recommend authors submit their research using any standard format they are comfortable with, and let Global Journals do the rest.

Alternatively, you can download our basic template from <https://globaljournals.org/Template.zip>

Authors should submit their complete paper/article, including text illustrations, graphics, conclusions, artwork, and tables. Authors who are not able to submit manuscript using the form above can email the manuscript department at submit@globaljournals.org or get in touch with chiefeditor@globaljournals.org if they wish to send the abstract before submission.

BEFORE AND DURING SUBMISSION

Authors must ensure the information provided during the submission of a paper is authentic. Please go through the following checklist before submitting:

1. Authors must go through the complete author guideline and understand and *agree to Global Journals' ethics and code of conduct*, along with author responsibilities.
2. Authors must accept the privacy policy, terms, and conditions of Global Journals.
3. Ensure corresponding author's email address and postal address are accurate and reachable.
4. Manuscript to be submitted must include keywords, an abstract, a paper title, co-author(s) names and details (email address, name, phone number, and institution), figures and illustrations in vector format including appropriate captions, tables, including titles and footnotes, a conclusion, results, acknowledgments and references.
5. Authors should submit paper in a ZIP archive if any supplementary files are required along with the paper.
6. Proper permissions must be acquired for the use of any copyrighted material.
7. Manuscript submitted *must not have been submitted or published elsewhere* and all authors must be aware of the submission.

Declaration of Conflicts of Interest

It is required for authors to declare all financial, institutional, and personal relationships with other individuals and organizations that could influence (bias) their research.

POLICY ON PLAGIARISM

Plagiarism is not acceptable in Global Journals submissions at all.

Plagiarized content will not be considered for publication. We reserve the right to inform authors' institutions about plagiarism detected either before or after publication. If plagiarism is identified, we will follow COPE guidelines:

Authors are solely responsible for all the plagiarism that is found. The author must not fabricate, falsify or plagiarize existing research data. The following, if copied, will be considered plagiarism:

- Words (language)
- Ideas
- Findings
- Writings
- Diagrams
- Graphs
- Illustrations
- Lectures



- Printed material
- Graphic representations
- Computer programs
- Electronic material
- Any other original work

AUTHORSHIP POLICIES

Global Journals follows the definition of authorship set up by the Open Association of Research Society, USA. According to its guidelines, authorship criteria must be based on:

1. Substantial contributions to the conception and acquisition of data, analysis, and interpretation of findings.
2. Drafting the paper and revising it critically regarding important academic content.
3. Final approval of the version of the paper to be published.

Changes in Authorship

The corresponding author should mention the name and complete details of all co-authors during submission and in manuscript. We support addition, rearrangement, manipulation, and deletions in authors list till the early view publication of the journal. We expect that corresponding author will notify all co-authors of submission. We follow COPE guidelines for changes in authorship.

Copyright

During submission of the manuscript, the author is confirming an exclusive license agreement with Global Journals which gives Global Journals the authority to reproduce, reuse, and republish authors' research. We also believe in flexible copyright terms where copyright may remain with authors/employers/institutions as well. Contact your editor after acceptance to choose your copyright policy. You may follow this form for copyright transfers.

Appealing Decisions

Unless specified in the notification, the Editorial Board's decision on publication of the paper is final and cannot be appealed before making the major change in the manuscript.

Acknowledgments

Contributors to the research other than authors credited should be mentioned in Acknowledgments. The source of funding for the research can be included. Suppliers of resources may be mentioned along with their addresses.

Declaration of funding sources

Global Journals is in partnership with various universities, laboratories, and other institutions worldwide in the research domain. Authors are requested to disclose their source of funding during every stage of their research, such as making analysis, performing laboratory operations, computing data, and using institutional resources, from writing an article to its submission. This will also help authors to get reimbursements by requesting an open access publication letter from Global Journals and submitting to the respective funding source.

PREPARING YOUR MANUSCRIPT

Authors can submit papers and articles in an acceptable file format: MS Word (doc, docx), LaTeX (.tex, .zip or .rar including all of your files), Adobe PDF (.pdf), rich text format (.rtf), simple text document (.txt), Open Document Text (.odt), and Apple Pages (.pages). Our professional layout editors will format the entire paper according to our official guidelines. This is one of the highlights of publishing with Global Journals—authors should not be concerned about the formatting of their paper. Global Journals accepts articles and manuscripts in every major language, be it Spanish, Chinese, Japanese, Portuguese, Russian, French, German, Dutch, Italian, Greek, or any other national language, but the title, subtitle, and abstract should be in English. This will facilitate indexing and the pre-peer review process.

The following is the official style and template developed for publication of a research paper. Authors are not required to follow this style during the submission of the paper. It is just for reference purposes.



Manuscript Style Instruction (Optional)

- Microsoft Word Document Setting Instructions.
- Font type of all text should be Swis721 Lt BT.
- Page size: 8.27" x 11", left margin: 0.65, right margin: 0.65, bottom margin: 0.75.
- Paper title should be in one column of font size 24.
- Author name in font size of 11 in one column.
- Abstract: font size 9 with the word "Abstract" in bold italics.
- Main text: font size 10 with two justified columns.
- Two columns with equal column width of 3.38 and spacing of 0.2.
- First character must be three lines drop-capped.
- The paragraph before spacing of 1 pt and after of 0 pt.
- Line spacing of 1 pt.
- Large images must be in one column.
- The names of first main headings (Heading 1) must be in Roman font, capital letters, and font size of 10.
- The names of second main headings (Heading 2) must not include numbers and must be in italics with a font size of 10.

Structure and Format of Manuscript

The recommended size of an original research paper is under 15,000 words and review papers under 7,000 words. Research articles should be less than 10,000 words. Research papers are usually longer than review papers. Review papers are reports of significant research (typically less than 7,000 words, including tables, figures, and references)

A research paper must include:

- a) A title which should be relevant to the theme of the paper.
- b) A summary, known as an abstract (less than 150 words), containing the major results and conclusions.
- c) Up to 10 keywords that precisely identify the paper's subject, purpose, and focus.
- d) An introduction, giving fundamental background objectives.
- e) Resources and techniques with sufficient complete experimental details (wherever possible by reference) to permit repetition, sources of information must be given, and numerical methods must be specified by reference.
- f) Results which should be presented concisely by well-designed tables and figures.
- g) Suitable statistical data should also be given.
- h) All data must have been gathered with attention to numerical detail in the planning stage.

Design has been recognized to be essential to experiments for a considerable time, and the editor has decided that any paper that appears not to have adequate numerical treatments of the data will be returned unrefereed.

- i) Discussion should cover implications and consequences and not just recapitulate the results; conclusions should also be summarized.
- j) There should be brief acknowledgments.
- k) There ought to be references in the conventional format. Global Journals recommends APA format.

Authors should carefully consider the preparation of papers to ensure that they communicate effectively. Papers are much more likely to be accepted if they are carefully designed and laid out, contain few or no errors, are summarizing, and follow instructions. They will also be published with much fewer delays than those that require much technical and editorial correction.

The Editorial Board reserves the right to make literary corrections and suggestions to improve brevity.



FORMAT STRUCTURE

It is necessary that authors take care in submitting a manuscript that is written in simple language and adheres to published guidelines.

All manuscripts submitted to Global Journals should include:

Title

The title page must carry an informative title that reflects the content, a running title (less than 45 characters together with spaces), names of the authors and co-authors, and the place(s) where the work was carried out.

Author details

The full postal address of any related author(s) must be specified.

Abstract

The abstract is the foundation of the research paper. It should be clear and concise and must contain the objective of the paper and inferences drawn. It is advised to not include big mathematical equations or complicated jargon.

Many researchers searching for information online will use search engines such as Google, Yahoo or others. By optimizing your paper for search engines, you will amplify the chance of someone finding it. In turn, this will make it more likely to be viewed and cited in further works. Global Journals has compiled these guidelines to facilitate you to maximize the web-friendliness of the most public part of your paper.

Keywords

A major lynchpin of research work for the writing of research papers is the keyword search, which one will employ to find both library and internet resources. Up to eleven keywords or very brief phrases have to be given to help data retrieval, mining, and indexing.

One must be persistent and creative in using keywords. An effective keyword search requires a strategy: planning of a list of possible keywords and phrases to try.

Choice of the main keywords is the first tool of writing a research paper. Research paper writing is an art. Keyword search should be as strategic as possible.

One should start brainstorming lists of potential keywords before even beginning searching. Think about the most important concepts related to research work. Ask, "What words would a source have to include to be truly valuable in a research paper?" Then consider synonyms for the important words.

It may take the discovery of only one important paper to steer in the right keyword direction because, in most databases, the keywords under which a research paper is abstracted are listed with the paper.

Numerical Methods

Numerical methods used should be transparent and, where appropriate, supported by references.

Abbreviations

Authors must list all the abbreviations used in the paper at the end of the paper or in a separate table before using them.

Formulas and equations

Authors are advised to submit any mathematical equation using either MathJax, KaTeX, or LaTeX, or in a very high-quality image.

Tables, Figures, and Figure Legends

Tables: Tables should be cautiously designed, uncrowned, and include only essential data. Each must have an Arabic number, e.g., Table 4, a self-explanatory caption, and be on a separate sheet. Authors must submit tables in an editable format and not as images. References to these tables (if any) must be mentioned accurately.



Figures

Figures are supposed to be submitted as separate files. Always include a citation in the text for each figure using Arabic numbers, e.g., Fig. 4. Artwork must be submitted online in vector electronic form or by emailing it.

PREPARATION OF ELETRONIC FIGURES FOR PUBLICATION

Although low-quality images are sufficient for review purposes, print publication requires high-quality images to prevent the final product being blurred or fuzzy. Submit (possibly by e-mail) EPS (line art) or TIFF (halftone/ photographs) files only. MS PowerPoint and Word Graphics are unsuitable for printed pictures. Avoid using pixel-oriented software. Scans (TIFF only) should have a resolution of at least 350 dpi (halftone) or 700 to 1100 dpi (line drawings). Please give the data for figures in black and white or submit a Color Work Agreement form. EPS files must be saved with fonts embedded (and with a TIFF preview, if possible).

For scanned images, the scanning resolution at final image size ought to be as follows to ensure good reproduction: line art: >650 dpi; halftones (including gel photographs): >350 dpi; figures containing both halftone and line images: >650 dpi.

Color charges: Authors are advised to pay the full cost for the reproduction of their color artwork. Hence, please note that if there is color artwork in your manuscript when it is accepted for publication, we would require you to complete and return a Color Work Agreement form before your paper can be published. Also, you can email your editor to remove the color fee after acceptance of the paper.

TIPS FOR WRITING A GOOD QUALITY ENGINEERING RESEARCH PAPER

Techniques for writing a good quality engineering research paper:

1. Choosing the topic: In most cases, the topic is selected by the interests of the author, but it can also be suggested by the guides. You can have several topics, and then judge which you are most comfortable with. This may be done by asking several questions of yourself, like "Will I be able to carry out a search in this area? Will I find all necessary resources to accomplish the search? Will I be able to find all information in this field area?" If the answer to this type of question is "yes," then you ought to choose that topic. In most cases, you may have to conduct surveys and visit several places. Also, you might have to do a lot of work to find all the rises and falls of the various data on that subject. Sometimes, detailed information plays a vital role, instead of short information. Evaluators are human: The first thing to remember is that evaluators are also human beings. They are not only meant for rejecting a paper. They are here to evaluate your paper. So present your best aspect.

2. Think like evaluators: If you are in confusion or getting demotivated because your paper may not be accepted by the evaluators, then think, and try to evaluate your paper like an evaluator. Try to understand what an evaluator wants in your research paper, and you will automatically have your answer. Make blueprints of paper: The outline is the plan or framework that will help you to arrange your thoughts. It will make your paper logical. But remember that all points of your outline must be related to the topic you have chosen.

3. Ask your guides: If you are having any difficulty with your research, then do not hesitate to share your difficulty with your guide (if you have one). They will surely help you out and resolve your doubts. If you can't clarify what exactly you require for your work, then ask your supervisor to help you with an alternative. He or she might also provide you with a list of essential readings.

4. Use of computer is recommended: As you are doing research in the field of research engineering then this point is quite obvious. Use right software: Always use good quality software packages. If you are not capable of judging good software, then you can lose the quality of your paper unknowingly. There are various programs available to help you which you can get through the internet.

5. Use the internet for help: An excellent start for your paper is using Google. It is a wondrous search engine, where you can have your doubts resolved. You may also read some answers for the frequent question of how to write your research paper or find a model research paper. You can download books from the internet. If you have all the required books, place importance on reading, selecting, and analyzing the specified information. Then sketch out your research paper. Use big pictures: You may use encyclopedias like Wikipedia to get pictures with the best resolution. At Global Journals, you should strictly follow [here](#).



6. Bookmarks are useful: When you read any book or magazine, you generally use bookmarks, right? It is a good habit which helps to not lose your continuity. You should always use bookmarks while searching on the internet also, which will make your search easier.

7. Revise what you wrote: When you write anything, always read it, summarize it, and then finalize it.

8. Make every effort: Make every effort to mention what you are going to write in your paper. That means always have a good start. Try to mention everything in the introduction—what is the need for a particular research paper. Polish your work with good writing skills and always give an evaluator what he wants. Make backups: When you are going to do any important thing like making a research paper, you should always have backup copies of it either on your computer or on paper. This protects you from losing any portion of your important data.

9. Produce good diagrams of your own: Always try to include good charts or diagrams in your paper to improve quality. Using several unnecessary diagrams will degrade the quality of your paper by creating a hodgepodge. So always try to include diagrams which were made by you to improve the readability of your paper. Use of direct quotes: When you do research relevant to literature, history, or current affairs, then use of quotes becomes essential, but if the study is relevant to science, use of quotes is not preferable.

10. Use proper verb tense: Use proper verb tenses in your paper. Use past tense to present those events that have happened. Use present tense to indicate events that are going on. Use future tense to indicate events that will happen in the future. Use of wrong tenses will confuse the evaluator. Avoid sentences that are incomplete.

11. Pick a good study spot: Always try to pick a spot for your research which is quiet. Not every spot is good for studying.

12. Know what you know: Always try to know what you know by making objectives, otherwise you will be confused and unable to achieve your target.

13. Use good grammar: Always use good grammar and words that will have a positive impact on the evaluator; use of good vocabulary does not mean using tough words which the evaluator has to find in a dictionary. Do not fragment sentences. Eliminate one-word sentences. Do not ever use a big word when a smaller one would suffice.

Verbs have to be in agreement with their subjects. In a research paper, do not start sentences with conjunctions or finish them with prepositions. When writing formally, it is advisable to never split an infinitive because someone will (wrongly) complain. Avoid clichés like a disease. Always shun irritating alliteration. Use language which is simple and straightforward. Put together a neat summary.

14. Arrangement of information: Each section of the main body should start with an opening sentence, and there should be a changeover at the end of the section. Give only valid and powerful arguments for your topic. You may also maintain your arguments with records.

15. Never start at the last minute: Always allow enough time for research work. Leaving everything to the last minute will degrade your paper and spoil your work.

16. Multitasking in research is not good: Doing several things at the same time is a bad habit in the case of research activity. Research is an area where everything has a particular time slot. Divide your research work into parts, and do a particular part in a particular time slot.

17. Never copy others' work: Never copy others' work and give it your name because if the evaluator has seen it anywhere, you will be in trouble. Take proper rest and food: No matter how many hours you spend on your research activity, if you are not taking care of your health, then all your efforts will have been in vain. For quality research, take proper rest and food.

18. Go to seminars: Attend seminars if the topic is relevant to your research area. Utilize all your resources.

19. Refresh your mind after intervals: Try to give your mind a rest by listening to soft music or sleeping in intervals. This will also improve your memory. Acquire colleagues: Always try to acquire colleagues. No matter how sharp you are, if you acquire colleagues, they can give you ideas which will be helpful to your research.

20. Think technically: Always think technically. If anything happens, search for its reasons, benefits, and demerits. Think and then print: When you go to print your paper, check that tables are not split, headings are not detached from their descriptions, and page sequence is maintained.



21. Adding unnecessary information: Do not add unnecessary information like "I have used MS Excel to draw graphs." Irrelevant and inappropriate material is superfluous. Foreign terminology and phrases are not apropos. One should never take a broad view. Analogy is like feathers on a snake. Use words properly, regardless of how others use them. Remove quotations. Puns are for kids, not grunt readers. Never oversimplify: When adding material to your research paper, never go for oversimplification; this will definitely irritate the evaluator. Be specific. Never use rhythmic redundancies. Contractions shouldn't be used in a research paper. Comparisons are as terrible as clichés. Give up ampersands, abbreviations, and so on. Remove commas that are not necessary. Parenthetical words should be between brackets or commas. Understatement is always the best way to put forward earth-shaking thoughts. Give a detailed literary review.

22. Report concluded results: Use concluded results. From raw data, filter the results, and then conclude your studies based on measurements and observations taken. An appropriate number of decimal places should be used. Parenthetical remarks are prohibited here. Proofread carefully at the final stage. At the end, give an outline to your arguments. Spot perspectives of further study of the subject. Justify your conclusion at the bottom sufficiently, which will probably include examples.

23. Upon conclusion: Once you have concluded your research, the next most important step is to present your findings. Presentation is extremely important as it is the definite medium through which your research is going to be in print for the rest of the crowd. Care should be taken to categorize your thoughts well and present them in a logical and neat manner. A good quality research paper format is essential because it serves to highlight your research paper and bring to light all necessary aspects of your research.

INFORMAL GUIDELINES OF RESEARCH PAPER WRITING

Key points to remember:

- Submit all work in its final form.
- Write your paper in the form which is presented in the guidelines using the template.
- Please note the criteria peer reviewers will use for grading the final paper.

Final points:

One purpose of organizing a research paper is to let people interpret your efforts selectively. The journal requires the following sections, submitted in the order listed, with each section starting on a new page:

The introduction: This will be compiled from reference matter and reflect the design processes or outline of basis that directed you to make a study. As you carry out the process of study, the method and process section will be constructed like that. The results segment will show related statistics in nearly sequential order and direct reviewers to similar intellectual paths throughout the data that you gathered to carry out your study.

The discussion section:

This will provide understanding of the data and projections as to the implications of the results. The use of good quality references throughout the paper will give the effort trustworthiness by representing an alertness to prior workings.

Writing a research paper is not an easy job, no matter how trouble-free the actual research or concept. Practice, excellent preparation, and controlled record-keeping are the only means to make straightforward progression.

General style:

Specific editorial column necessities for compliance of a manuscript will always take over from directions in these general guidelines.

To make a paper clear: Adhere to recommended page limits.

Mistakes to avoid:

- Insertion of a title at the foot of a page with subsequent text on the next page.
- Separating a table, chart, or figure—confine each to a single page.
- Submitting a manuscript with pages out of sequence.
- In every section of your document, use standard writing style, including articles ("a" and "the").
- Keep paying attention to the topic of the paper.



- Use paragraphs to split each significant point (excluding the abstract).
- Align the primary line of each section.
- Present your points in sound order.
- Use present tense to report well-accepted matters.
- Use past tense to describe specific results.
- Do not use familiar wording; don't address the reviewer directly. Don't use slang or superlatives.
- Avoid use of extra pictures—include only those figures essential to presenting results.

Title page:

Choose a revealing title. It should be short and include the name(s) and address(es) of all authors. It should not have acronyms or abbreviations or exceed two printed lines.

Abstract: This summary should be two hundred words or less. It should clearly and briefly explain the key findings reported in the manuscript and must have precise statistics. It should not have acronyms or abbreviations. It should be logical in itself. Do not cite references at this point.

An abstract is a brief, distinct paragraph summary of finished work or work in development. In a minute or less, a reviewer can be taught the foundation behind the study, common approaches to the problem, relevant results, and significant conclusions or new questions.

Write your summary when your paper is completed because how can you write the summary of anything which is not yet written? Wealth of terminology is very essential in abstract. Use comprehensive sentences, and do not sacrifice readability for brevity; you can maintain it succinctly by phrasing sentences so that they provide more than a lone rationale. The author can at this moment go straight to shortening the outcome. Sum up the study with the subsequent elements in any summary. Try to limit the initial two items to no more than one line each.

Reason for writing the article—theory, overall issue, purpose.

- Fundamental goal.
- To-the-point depiction of the research.
- Consequences, including definite statistics—if the consequences are quantitative in nature, account for this; results of any numerical analysis should be reported. Significant conclusions or questions that emerge from the research.

Approach:

- Single section and succinct.
- An outline of the job done is always written in past tense.
- Concentrate on shortening results—limit background information to a verdict or two.
- Exact spelling, clarity of sentences and phrases, and appropriate reporting of quantities (proper units, important statistics) are just as significant in an abstract as they are anywhere else.

Introduction:

The introduction should "introduce" the manuscript. The reviewer should be presented with sufficient background information to be capable of comprehending and calculating the purpose of your study without having to refer to other works. The basis for the study should be offered. Give the most important references, but avoid making a comprehensive appraisal of the topic. Describe the problem visibly. If the problem is not acknowledged in a logical, reasonable way, the reviewer will give no attention to your results. Speak in common terms about techniques used to explain the problem, if needed, but do not present any particulars about the protocols here.

The following approach can create a valuable beginning:

- Explain the value (significance) of the study.
- Defend the model—why did you employ this particular system or method? What is its compensation? Remark upon its appropriateness from an abstract point of view as well as pointing out sensible reasons for using it.
- Present a justification. State your particular theory(-ies) or aim(s), and describe the logic that led you to choose them.
- Briefly explain the study's tentative purpose and how it meets the declared objectives.



Approach:

Use past tense except for when referring to recognized facts. After all, the manuscript will be submitted after the entire job is done. Sort out your thoughts; manufacture one key point for every section. If you make the four points listed above, you will need at least four paragraphs. Present surrounding information only when it is necessary to support a situation. The reviewer does not desire to read everything you know about a topic. Shape the theory specifically—do not take a broad view.

As always, give awareness to spelling, simplicity, and correctness of sentences and phrases.

Procedures (methods and materials):

This part is supposed to be the easiest to carve if you have good skills. A soundly written procedures segment allows a capable scientist to replicate your results. Present precise information about your supplies. The suppliers and clarity of reagents can be helpful bits of information. Present methods in sequential order, but linked methodologies can be grouped as a segment. Be concise when relating the protocols. Attempt to give the least amount of information that would permit another capable scientist to replicate your outcome, but be cautious that vital information is integrated. The use of subheadings is suggested and ought to be synchronized with the results section.

When a technique is used that has been well-described in another section, mention the specific item describing the way, but draw the basic principle while stating the situation. The purpose is to show all particular resources and broad procedures so that another person may use some or all of the methods in one more study or referee the scientific value of your work. It is not to be a step-by-step report of the whole thing you did, nor is a methods section a set of orders.

Materials:

Materials may be reported in part of a section or else they may be recognized along with your measures.

Methods:

- Report the method and not the particulars of each process that engaged the same methodology.
- Describe the method entirely.
- To be succinct, present methods under headings dedicated to specific dealings or groups of measures.
- Simplify—detail how procedures were completed, not how they were performed on a particular day.
- If well-known procedures were used, account for the procedure by name, possibly with a reference, and that's all.

Approach:

It is embarrassing to use vigorous voice when documenting methods without using first person, which would focus the reviewer's interest on the researcher rather than the job. As a result, when writing up the methods, most authors use third person passive voice.

Use standard style in this and every other part of the paper—avoid familiar lists, and use full sentences.

What to keep away from:

- Resources and methods are not a set of information.
- Skip all descriptive information and surroundings—save it for the argument.
- Leave out information that is immaterial to a third party.

Results:

The principle of a results segment is to present and demonstrate your conclusion. Create this part as entirely objective details of the outcome, and save all understanding for the discussion.

The page length of this segment is set by the sum and types of data to be reported. Use statistics and tables, if suitable, to present consequences most efficiently.

You must clearly differentiate material which would usually be incorporated in a study editorial from any unprocessed data or additional appendix matter that would not be available. In fact, such matters should not be submitted at all except if requested by the instructor.



Content:

- Sum up your conclusions in text and demonstrate them, if suitable, with figures and tables.
- In the manuscript, explain each of your consequences, and point the reader to remarks that are most appropriate.
- Present a background, such as by describing the question that was addressed by creation of an exacting study.
- Explain results of control experiments and give remarks that are not accessible in a prescribed figure or table, if appropriate.
- Examine your data, then prepare the analyzed (transformed) data in the form of a figure (graph), table, or manuscript.

What to stay away from:

- Do not discuss or infer your outcome, report surrounding information, or try to explain anything.
- Do not include raw data or intermediate calculations in a research manuscript.
- Do not present similar data more than once.
- A manuscript should complement any figures or tables, not duplicate information.
- Never confuse figures with tables—there is a difference.

Approach:

As always, use past tense when you submit your results, and put the whole thing in a reasonable order.

Put figures and tables, appropriately numbered, in order at the end of the report.

If you desire, you may place your figures and tables properly within the text of your results section.

Figures and tables:

If you put figures and tables at the end of some details, make certain that they are visibly distinguished from any attached appendix materials, such as raw facts. Whatever the position, each table must be titled, numbered one after the other, and include a heading. All figures and tables must be divided from the text.

Discussion:

The discussion is expected to be the trickiest segment to write. A lot of papers submitted to the journal are discarded based on problems with the discussion. There is no rule for how long an argument should be.

Position your understanding of the outcome visibly to lead the reviewer through your conclusions, and then finish the paper with a summing up of the implications of the study. The purpose here is to offer an understanding of your results and support all of your conclusions, using facts from your research and generally accepted information, if suitable. The implication of results should be fully described.

Infer your data in the conversation in suitable depth. This means that when you clarify an observable fact, you must explain mechanisms that may account for the observation. If your results vary from your prospect, make clear why that may have happened. If your results agree, then explain the theory that the proof supported. It is never suitable to just state that the data approved the prospect, and let it drop at that. Make a decision as to whether each premise is supported or discarded or if you cannot make a conclusion with assurance. Do not just dismiss a study or part of a study as "uncertain."

Research papers are not acknowledged if the work is imperfect. Draw what conclusions you can based upon the results that you have, and take care of the study as a finished work.

- You may propose future guidelines, such as how an experiment might be personalized to accomplish a new idea.
- Give details of all of your remarks as much as possible, focusing on mechanisms.
- Make a decision as to whether the tentative design sufficiently addressed the theory and whether or not it was correctly restricted. Try to present substitute explanations if they are sensible alternatives.
- One piece of research will not counter an overall question, so maintain the large picture in mind. Where do you go next? The best studies unlock new avenues of study. What questions remain?
- Recommendations for detailed papers will offer supplementary suggestions.



Approach:

When you refer to information, differentiate data generated by your own studies from other available information. Present work done by specific persons (including you) in past tense.

Describe generally acknowledged facts and main beliefs in present tense.

THE ADMINISTRATION RULES

Administration Rules to Be Strictly Followed before Submitting Your Research Paper to Global Journals Inc.

Please read the following rules and regulations carefully before submitting your research paper to Global Journals Inc. to avoid rejection.

Segment draft and final research paper: You have to strictly follow the template of a research paper, failing which your paper may get rejected. You are expected to write each part of the paper wholly on your own. The peer reviewers need to identify your own perspective of the concepts in your own terms. Please do not extract straight from any other source, and do not rephrase someone else's analysis. Do not allow anyone else to proofread your manuscript.

Written material: You may discuss this with your guides and key sources. Do not copy anyone else's paper, even if this is only imitation, otherwise it will be rejected on the grounds of plagiarism, which is illegal. Various methods to avoid plagiarism are strictly applied by us to every paper, and, if found guilty, you may be blacklisted, which could affect your career adversely. To guard yourself and others from possible illegal use, please do not permit anyone to use or even read your paper and file.



CRITERION FOR GRADING A RESEARCH PAPER (COMPILATION)
BY GLOBAL JOURNALS

Please note that following table is only a Grading of "Paper Compilation" and not on "Performed/Stated Research" whose grading solely depends on Individual Assigned Peer Reviewer and Editorial Board Member. These can be available only on request and after decision of Paper. This report will be the property of Global Journals.

Topics	Grades		
	A-B	C-D	E-F
<i>Abstract</i>	Clear and concise with appropriate content, Correct format. 200 words or below	Unclear summary and no specific data, Incorrect form Above 200 words	No specific data with ambiguous information Above 250 words
<i>Introduction</i>	Containing all background details with clear goal and appropriate details, flow specification, no grammar and spelling mistake, well organized sentence and paragraph, reference cited	Unclear and confusing data, appropriate format, grammar and spelling errors with unorganized matter	Out of place depth and content, hazy format
<i>Methods and Procedures</i>	Clear and to the point with well arranged paragraph, precision and accuracy of facts and figures, well organized subheads	Difficult to comprehend with embarrassed text, too much explanation but completed	Incorrect and unorganized structure with hazy meaning
<i>Result</i>	Well organized, Clear and specific, Correct units with precision, correct data, well structuring of paragraph, no grammar and spelling mistake	Complete and embarrassed text, difficult to comprehend	Irregular format with wrong facts and figures
<i>Discussion</i>	Well organized, meaningful specification, sound conclusion, logical and concise explanation, highly structured paragraph reference cited	Wordy, unclear conclusion, spurious	Conclusion is not cited, unorganized, difficult to comprehend
<i>References</i>	Complete and correct format, well organized	Beside the point, Incomplete	Wrong format and structuring



INDEX

A

Aeration · 13, 22, 24

D

Distilled · 25

E

Equipped · 2

M

Microorganisms · 12, 24

P

Plotted · 19

Q

Quadratic · 13, 27

S

Submerged · 6

U

Uninterrupted · 2



save our planet



Global Journal of Researches in Engineering

Visit us on the Web at www.GlobalJournals.org | www.EngineeringResearch.org
or email us at helpdesk@globaljournals.org

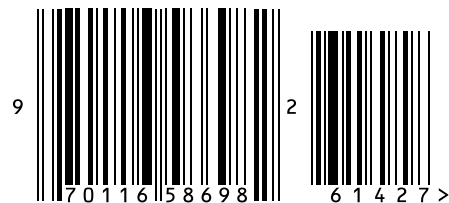

ISSN 9755861

© Global Journals